



LED Parking Garage Light

KP Series



KP Series

Beyond LED Technology's KP Series Parking Garage fixture is fully-featured and the most innovative product of its kind. This new 2021 model offers CCT Adjustable options of 3000K, 4000K & 5000K. At Beyond LED we know every parking garage application is unique. To that end, our approach is to apply a total space evaluation to understand what you want to accomplish, so we can design a lighting solution for the total parking garage space. KP Series fixtures offer high-performance, energy-efficiency, and the best technology to deliver parking garage lighting for optimum "sealability", safety, and security. Beyond LED products are supported by pre-sale & post-sale service, and layout assistance.

- Up to 130 Lumens per watt
- CCT Changeable 3000K, 4000K & 5000K
- New housing design for quick and easy mounting and installation
- UV-stabilized acrylic prismatic refractor with self-retaining screws
- 3/4" conduit entry on top for pendant mounting
- 1/2" conduit entries on two sides
- IP65 Waterproof Rated
- Universal 100-277Vac

LED Parking Garage Light

KP Series

KP Series

SKU #	Model #	Watts	Lumens	CCT	IP	Input Voltage	Certifications
151395	BLT-PG05B-40WAT2A1-abcd	40W	4425-5293Lm	3/4/5K Adjustable	IP65	100-277Vac 50/60Hz	UL & DLC
151238	BLT-PG05B-55WAT2A1-abcd	55W	6297-7546Lm	3/4/5K Adjustable	IP65	100-277Vac 50/60Hz	UL & DLC
151393	BLT-PG05B-75WAT2A1-abcd	75W	8876-10485Lm	3/4/5K Adjustable	IP65	100-277Vac 50/60Hz	UL & DLC
151239	BLT-PG05B-100WAT2A1-abcd	100W	11946-13999Lm	3/4/5K Adjustable	IP65	100-277Vac 50/60Hz	UL & DLC

Mounting Options

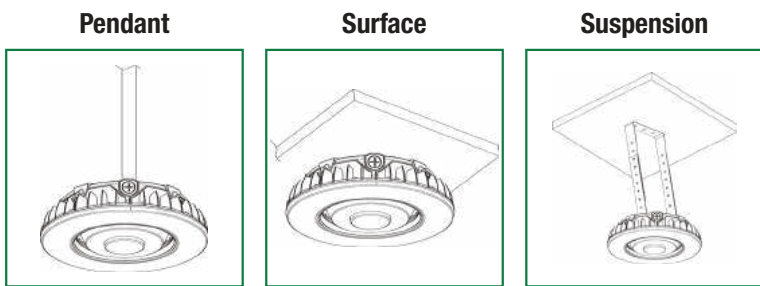

3000K / 4000K / 5000K CCT Adjustable

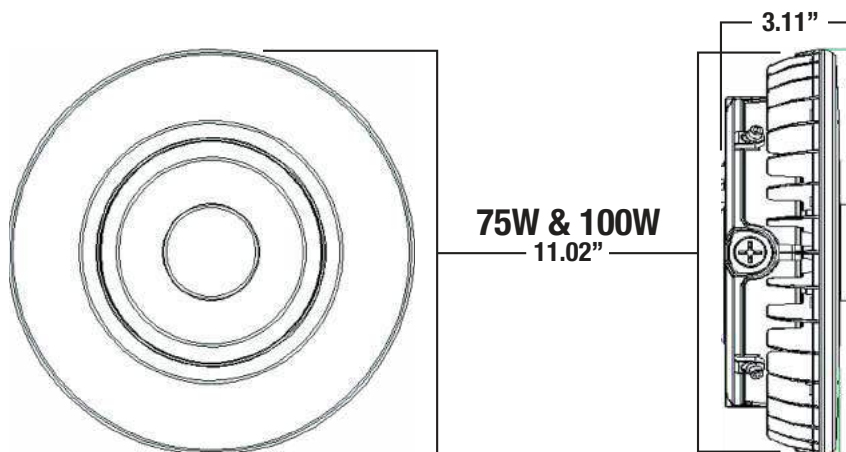
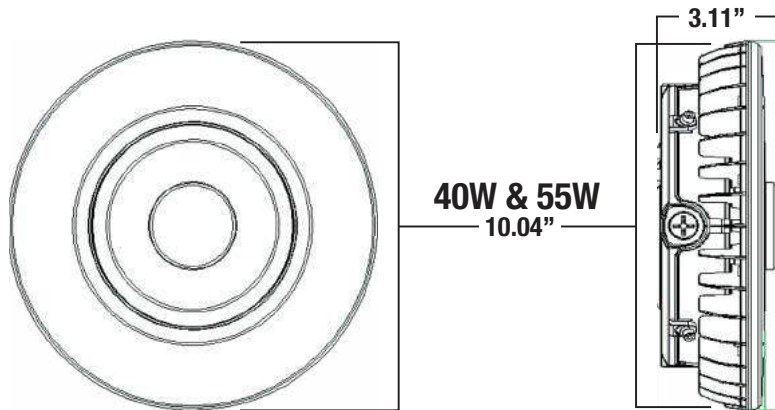
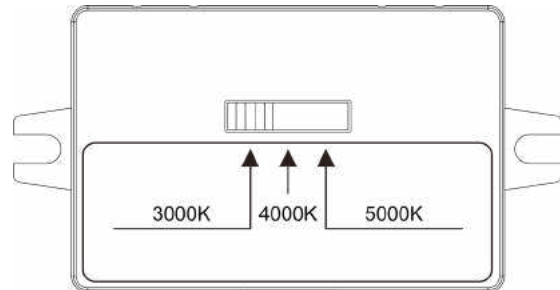

CORRELATED COLOR TEMPERATURE (CCT)

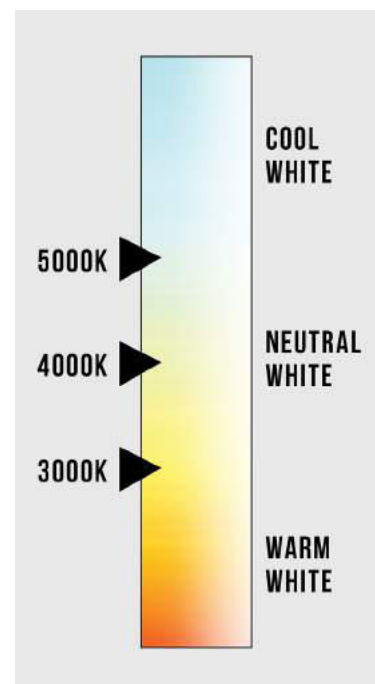



LED Parking Garage Light

KP Series

40W Specifications

OPTICAL	CRI	>80
	Viewing Angle	150Degree
ELECTRICAL	Input Voltage	100-277VAC 50/60Hz
	PF	≥0.9
	THD	≤20%
	Driver Model	Beyond Brand Driver
MATERIALS	LED Type	SMD2835 (0.5W)
	LED QTY	72 PCS 3000K + 72PCS 5000K
	Housing	Aluminum Alloy
	Housing Color	White
	Cover	Stripe lens
	Waterproof Rating	WET (IP65)
OTHERS	Operating Temperature	-30°C TO 50°C
	Operating Humidity	10%-90% RH
	Storage Temperature	-40°C TO 85°C
	Storage Humidity	10%-95% RH
	Warranty Time	5 Years



Packaging

Tolerance of Carton Size: ±0.590551 in, Tolerance of Weight: ±10%.

Model	Pcs/Box	Dimensions	Weight	Pallet Quantity	Pallet Weight	Pallet Dimensions
40W	1	13" X 13" X 6"	6 Lb			

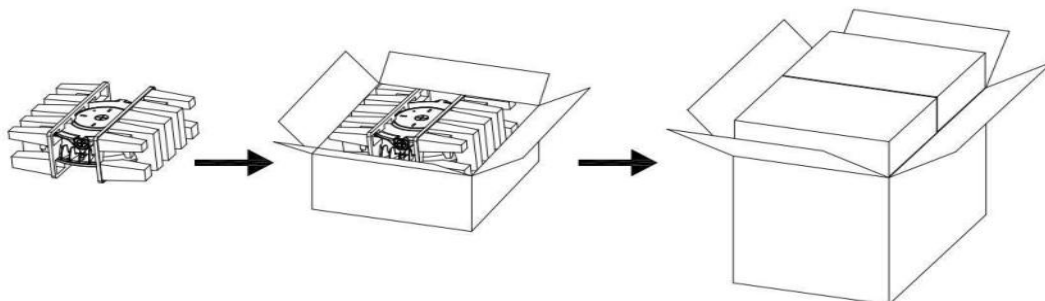

LED Parking Garage Light

KP Series

40W Distribution Diagram

Luminaire Property

Luminaire Manufacturer:
Voltage: 121.8 V
Power: 37.62 W

Current: 0.313 A
Power Factor: 0.986

Photometric Results

IES Classification: Type IV
Total Rated Lamp Lumens: 5029.7 lm
Efficiency: 100%
Upward Ratio: 3%
Central Intensity: 951.04 cd
Pos of Max. Intensity: H315 V44

Longitudinal Classification: Very Short
Measurement Flux: 5029.7 lm
Downward Ratio: 97%
Luminaire Efficacy Rating (LER): 133.75
Max. Intensity: 1203.67 cd

Luminous Intensity Distribution Curve

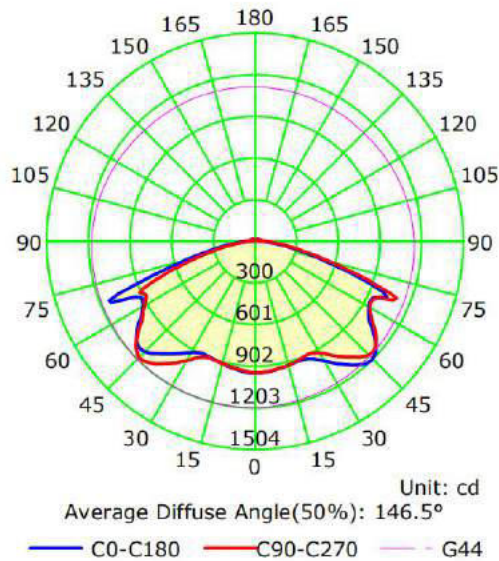

Illuminance at a Distance(Beam Angle)

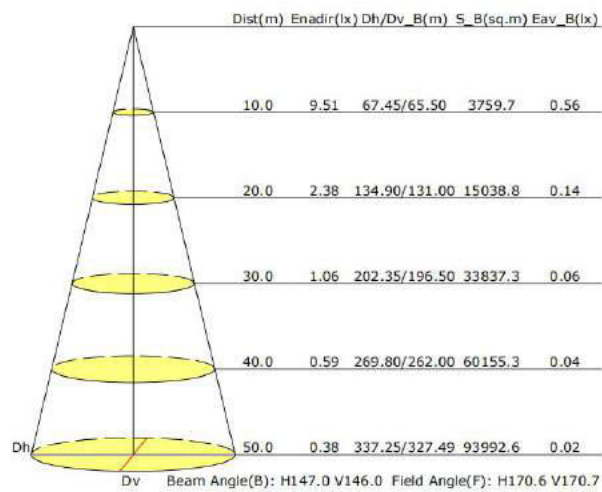



LED Parking Garage Light

KP Series

55W Specifications

OPTICAL	CRI	>80
	Viewing Angle	150Degree
ELECTRICAL	Input Voltage	100-277VAC 50/60Hz
	PF	≥0.9
	THD	≤20%
	Driver Model	Beyond Brand Driver
MATERIALS	LED Type	SMD2835 (0.5W)
	LED QTY	120 PCS 3000K +120PCS 5000K
	Housing	Aluminum Alloy
	Housing Color	White
	Cover	Stripe lens
	Waterproof Rating	WET (IP65)
OTHERS	Operating Temperature	-22°F to 122°F
	Operating Humidity	10%-90% RH
	Storage Temperature	-40°F to 185°F
	Storage Humidity	10%-95% RH
	Warranty Time	5 Years



Packaging

Tolerance of Carton Size: ±0.590551 in, Tolerance of Weight: ±10%.

Model	Pcs/Box	Dimensions	Weight	Pallet Quantity	Pallet Weight	Pallet Dimensions
55W	1	13" X 13" X 6"	6 Lb			

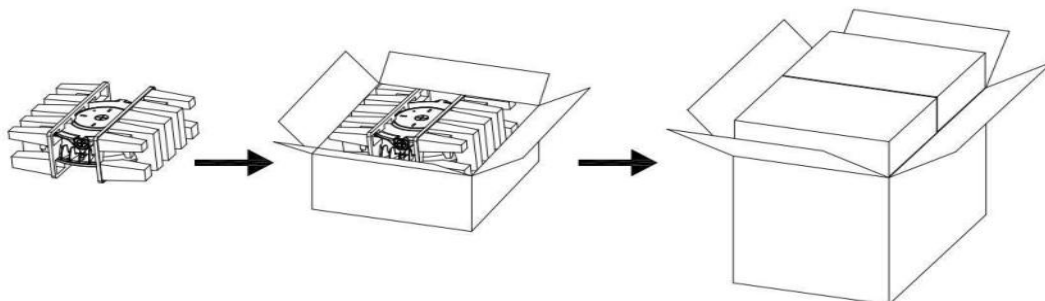

LED Parking Garage Light

KP Series

55W Distribution Diagram

Luminaire Property

Luminaire Manufacturer:
Voltage: 120.6 V
Power: 55.40 W

Current: 0.468 A
Power Factor: 0.990

Photometric Results

CIE Class: Direct
Measurement Flux: 6685.8 lm
Downward Ratio: 99%
Horizontal Diffuse Angle(50%): H145
Vertical Diffuse Angle(50%): V145.1
Luminaire Efficacy Rating (LER): 120.73
Max. Intensity: 1626.45 cd
S/MH(C0/C180): 1.90

Total Rated Lamp Lumens: 6685.8 lm
Efficiency: 100%
Upward Ratio: 1%

Central Intensity: 1118.11 cd
Pos of Max. Intensity: H45 V60
S/MH(C90/C270): 1.86

Luminous Intensity Distribution Curve

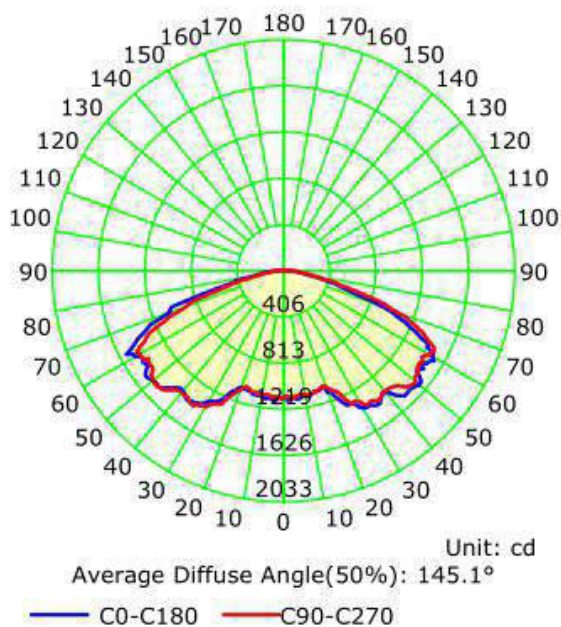

Illuminance at a Distance

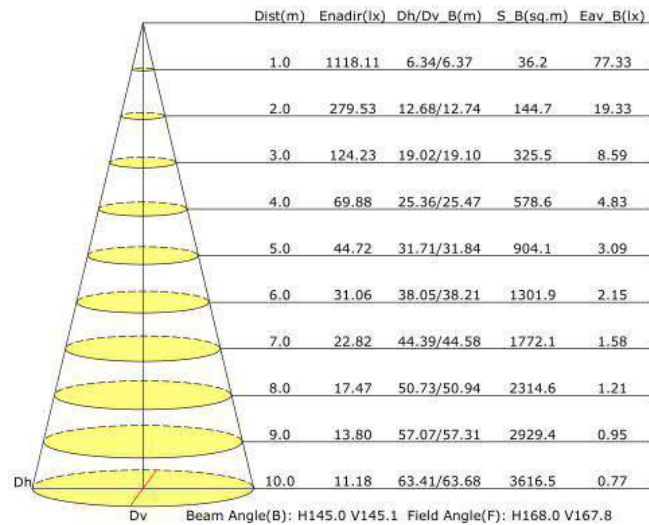

LED Parking Garage Light

KP Series

75W Specifications

OPTICAL	CRI	>80
	Viewing Angle	150Degree
ELECTRICAL	Input Voltage	100-277VAC 50/60Hz
	PF	≥0.9
	THD	≤20%
	Driver Model	Beyond Brand Driver
MATERIALS	LED Type	SMD2835 (0.5W)
	LED QTY	168 PCS 3000K + 168PCS 5000K
	Housing	Aluminum Alloy
	Housing Color	White
	Cover	Stripe lens
	Waterproof Rating	WET (IP65)
OTHERS	Operating Temperature	-22°F to 122°F
	Operating Humidity	10%-90% RH
	Storage Temperature	-40°F to 185°F
	Storage Humidity	10%-95% RH
	Warranty Time	5 Years



Packaging

Tolerance of Carton Size: ±0.590551 in, Tolerance of Weight: ±10%.

Model	Pcs/Box	Dimensions	Weight	Pallet Quantity	Pallet Weight	Pallet Dimensions
75W	1	13" X 13" X 6"	8 Lb			

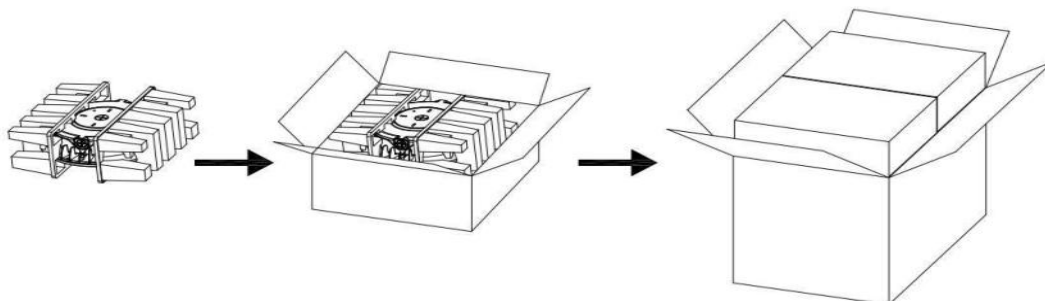

LED Parking Garage Light

KP Series

75W Distribution Diagram

Luminaire Property

Luminaire Manufacturer:
Voltage: 121.6 V
Power: 73.31 W

Current: 0.610 A
Power Factor: 0.987

Photometric Results

IES Classification: Type IV
Total Rated Lamp Lumens: 9140.3 lm
Efficiency: 100%
Upward Ratio: 3%
Central Intensity: 1578.48 cd
Pos of Max. Intensity: H255 V23

Longitudinal Classification: Very Short
Measurement Flux: 9140.3 lm
Downward Ratio: 97%
Luminaire Efficacy Rating (LER): 124.73
Max. Intensity: 2147.23 cd

Luminous Intensity Distribution Curve

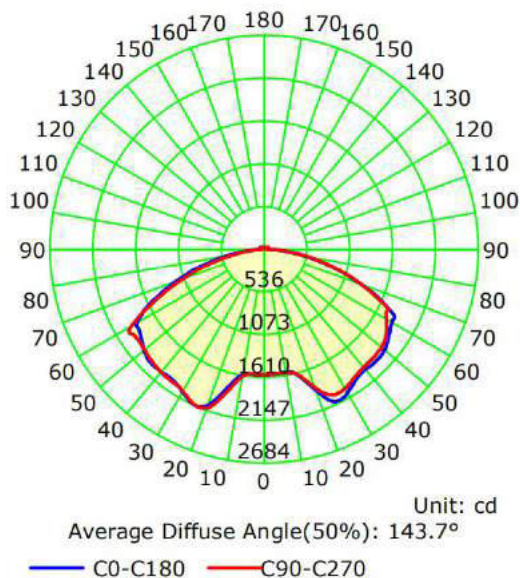

Illuminance at a Distance

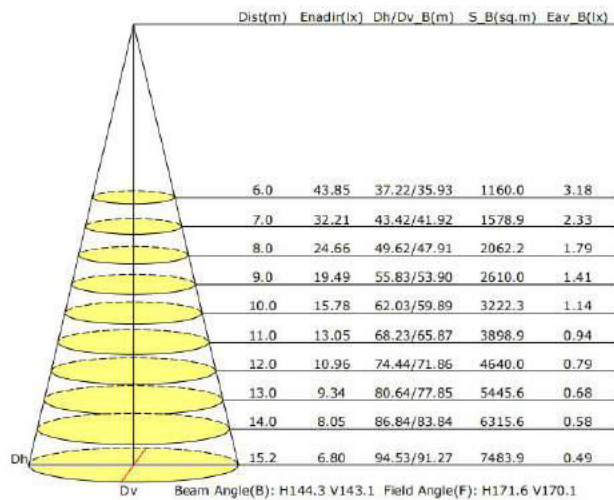



LED Parking Garage Light

KP Series

100W Specifications

OPTICAL	CRI	>80
	Viewing Angle	150Degree
ELECTRICAL	Input Voltage	100-277VAC 50/60Hz
	PF	≥0.9
	THD	≤20%
	Driver Model	Beyond Brand Driver
MATERIALS	LED Type	SMD2835 (0.5W)
	LED QTY	240PCS 3000K + 240PCS 5000K
	Housing	Aluminum Alloy
	Housing Color	White
	Cover	Stripe lens
	Waterproof Rating	WET (IP65)
OTHERS	Operating Temperature	-22°F to 122°F
	Operating Humidity	10%-90% RH
	Storage Temperature	-40°F to 185°F
	Storage Humidity	10%-95% RH
	Warranty Time	5 Years



Packaging

Tolerance of Carton Size: ±0.590551 in, Tolerance of Weight: ±10%.

Model	Pcs/Box	Dimensions	Weight	Pallet Quantity	Pallet Weight	Pallet Dimensions
100W	1	13" X 13" X 6"	8 Lb			

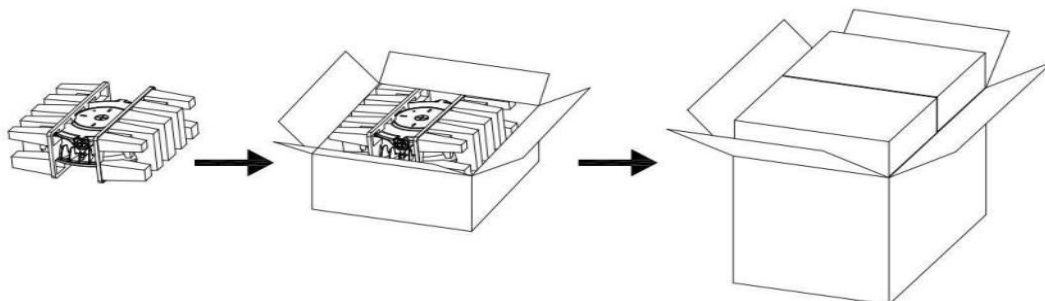

LED Parking Garage Light

KP Series

100W Distribution Diagram

Luminaire Property

Luminaire Manufacturer:

Voltage: 121.4 V

Power: 102.70 W

Current: 0.848 A

Power Factor: 0.997

Photometric Results

CIE Class: Direct

Measurement Flux: 12376.2 lm

Downward Ratio: 99%

Horizontal Diffuse Angle(50%): H144.8

Vertical Diffuse Angle(50%): V145.6

Luminaire Efficacy Rating (LER): 120.56

Max. Intensity: 2958.65 cd

S/MH(C0/C180): 1.84

Total Rated Lamp Lumens: 12376.2 lm

Efficiency: 100%

Upward Ratio: 1%

Central Intensity: 2216.2 cd

Pos of Max. Intensity: H0 V32

S/MH(C90/C270): 1.79

Luminous Intensity Distribution Curve

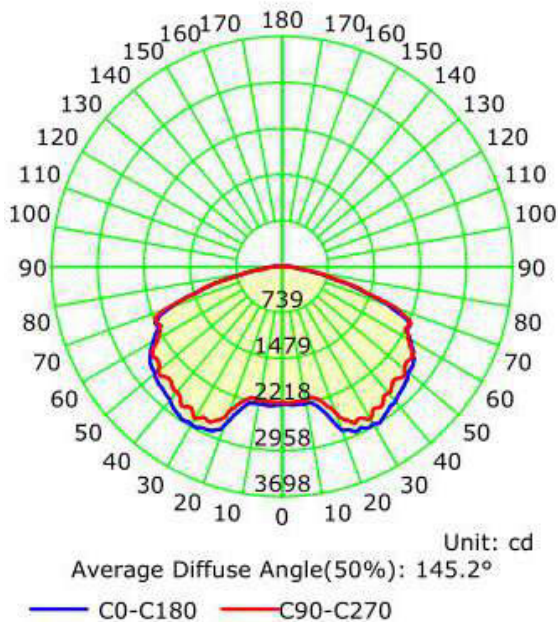

Illuminance at a Distance

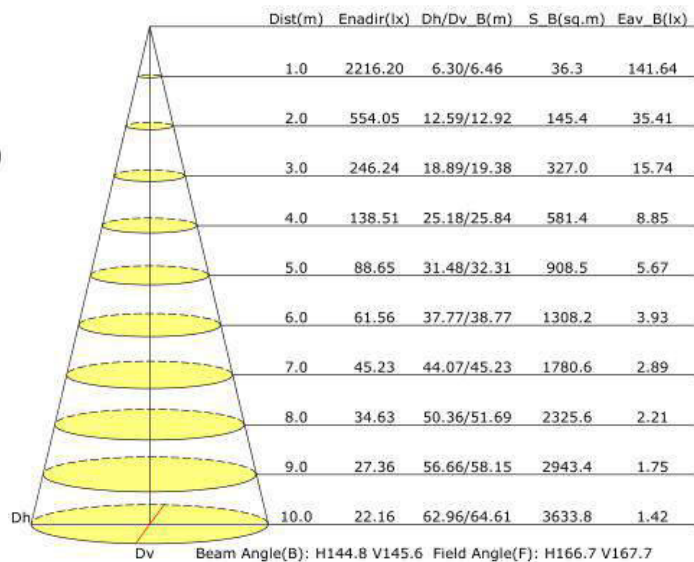



LED Parking Garage Light KP Series

Installation

Cautions:

1. Can not use the electric generator to test the LED lamp.
2. Please abide by related country, regional and local law and regulations when install this fixture.
3. Please turn off the power before installation or maintenance.
4. Proper earth grounding is required to ensure safety.

Notice:

1. To avoid possibility of electrical shock or fire, the installation personnel must have professional electric knowledge.
2. Please wear gloves to avoid injury before installation.
3. If any smoke or spark of the wire happened, please turn off the power immediately and notify relevant personnel.

Attention:

1. Please check if there is any damage during shipping. If so, please contact manufacturer timely.
2. Please read the installation instruction carefully to check whether all the accessories are complete. After confirmation, then install the fixture according to installation steps.

Wiring Diagram:

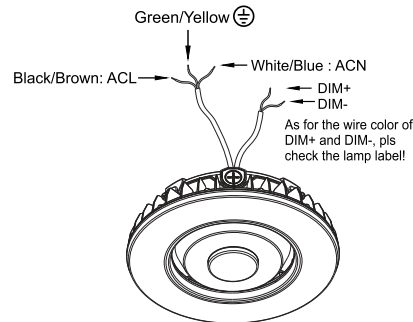

Installation Method I :

1. Disassemble the driver box cover; Figure 1-1
2. Loosen the 3/4 plug on the driver box cover by screwdriver; Figure 1-2
3. Fix the driver box cover on the 3/4 tube; Figure 1-3
4. Cling the safety rope in the driver box to the hook inside the driver box; Figure 1-4
5. Connect the input line and ground; If the fixture is equipped with sensor, adjust the sensor settings, Take relevant waterproof measures after the wires are connected ;Figure 1-5
6. Align the drive box cover with the metal shrapnel inside the drive box and press upward to fasten it together. Figure 1-6
7. Lock the four screws, the product is installed. Figure 1-7

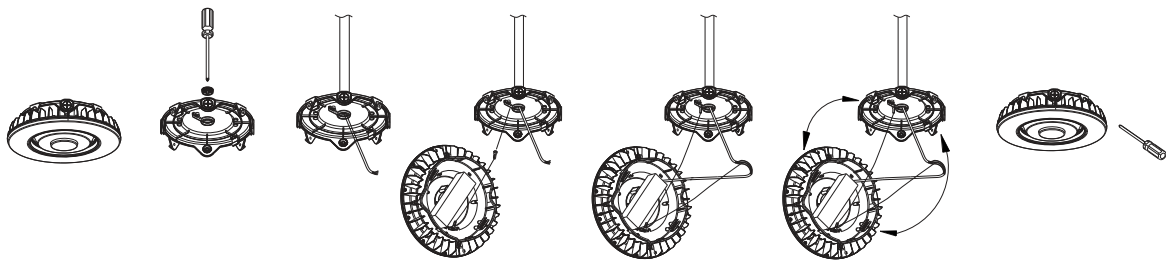

Figure 1-1

Figure 1-2

Figure 1-3

Figure 1-4

Figure 1-5

Figure 1-6

Figure 1-7

Installation Method II :

1. Disassemble the driver box cover; Figure 2-1
2. Loosen the 3/4 plug on the driver box cover by screwdriver; Figure 2-2
3. Drill the holes on the ceiling accordingly to fit the plate; Figure 2-3
4. Fix the driver box cover on the ceiling; Figure 2-4
5. Cling the safety rope in the driver box to the hook inside the driver box; Figure 2-5
6. Connect the input line and ground; If the fixture is equipped with sensor, adjust the sensor settings; Take relevant waterproof measures after the wires are connected ;Figure 2-6
7. Align the drive box cover with the metal shrapnel inside the drive box and press upward to fasten it together. Figure 2-7
8. Lock the four screws, the product is installed. Figure 2-8

LED Parking Garage Light

KP Series

Installation



Figure 2-1

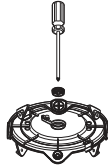

Figure 2-2

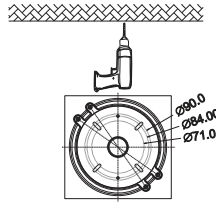

Figure 2-3

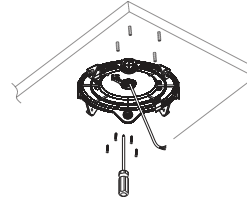

Figure 2-4

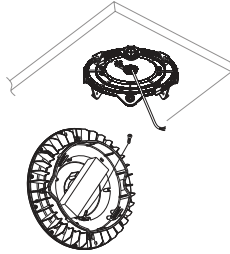

Figure 2-5

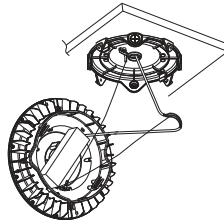

Figure 2-6

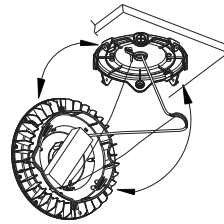

Figure 2-7

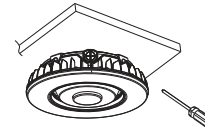

Figure 2-8

□ Installation Method III :

1. Disassemble the driver box cover; Figure 3-1
2. Loosen the 3/4 plug on the driver box cover by screwdriver; Figure 3-2
3. Drill holes on the ceiling; Figure 3-3
4. Fix the upper bracket on the ceiling; Figure 3-4
5. Fix the lower bracket on the driver box cover; Figure 3-5
6. Align with the holes of upper and lower bracket; tighten with screws; Figure 3-6
7. Cling the safety rope in the driver box to the hook inside the driver box; Figure 3-7
8. Use M20 waterproof connector when connecting AC wire or dimming wire, take relevant waterproof measures at both sides of inlet. Figure 3-8
9. Connect the input line and ground; If the fixture is equipped with sensor, adjust the sensor settings; Take relevant waterproof measures after the wires are connected ;Figure 3-9
10. Align the drive box cover with the metal shrapnel inside the drive box and press upward to fasten it together. Figure 3-10
11. Lock the four screws, the product is installed. Figure 3-11



Figure 3-1



Figure 3-2

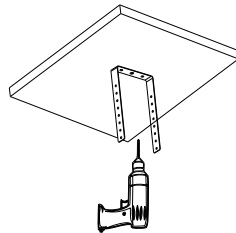

Figure 3-3

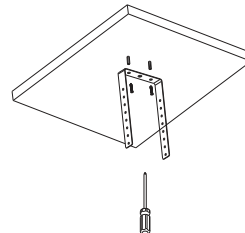

Figure 3-4



Figure 3-5

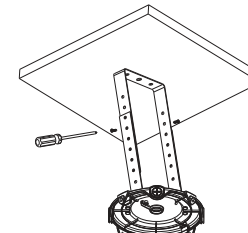

Figure 3-6

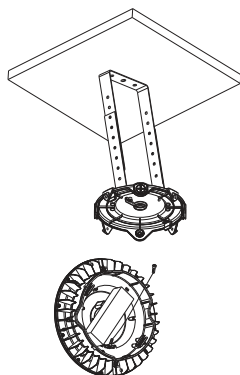

Figure 3-7

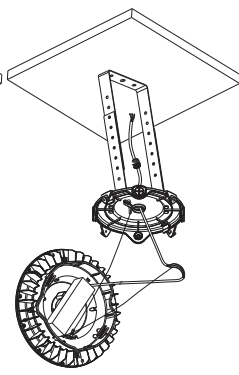

Figure 3-8

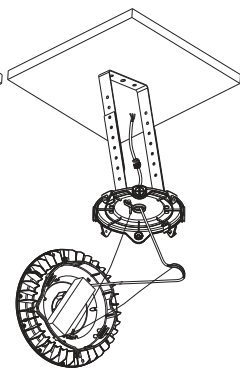

Figure 3-9

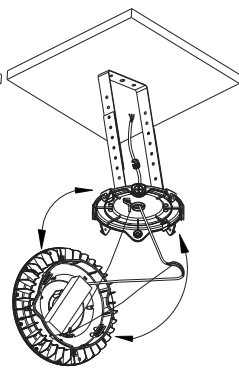

Figure 3-10

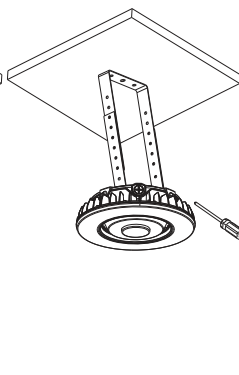

Figure 3-11



LED Parking Garage Light KP Series

Installation

Adjust the color temperature through the switch:

Move the switch left and right to get the desired color temperature.

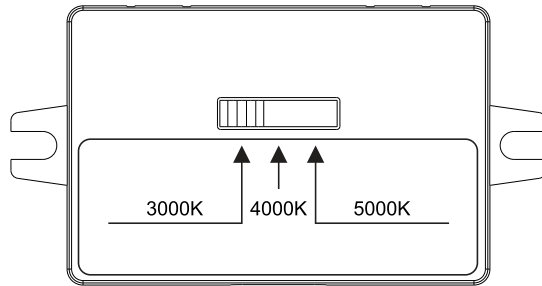

PARAMETER SETTING BY REMOTE CONTROL IN MANUAL OF RC-100 Wiring Diagrams

BRI823-B-D wiring with dimming ballast or LED driver.
Dimming Driver

BRI823-B-D wiring with non-dimming ballast or LED driver.
Non-Dimming Driver

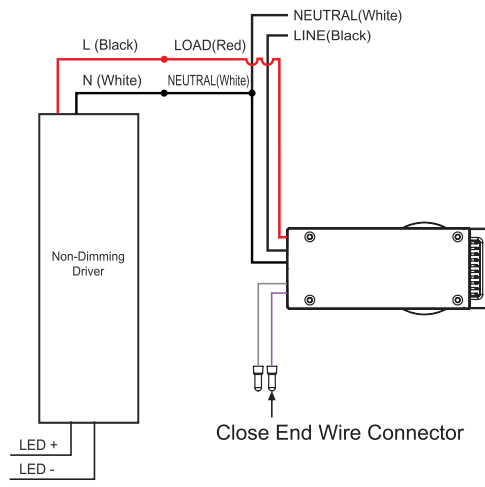
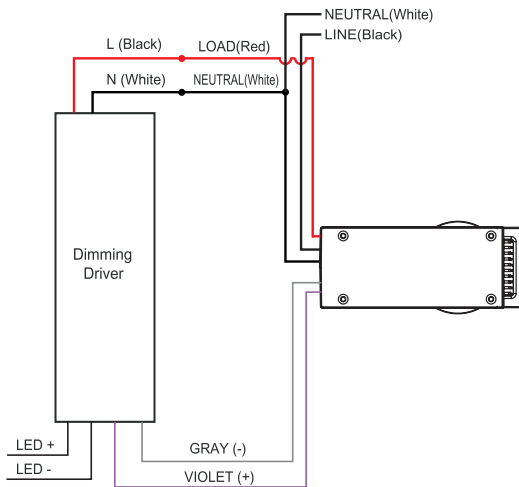

Structure of motion sensor

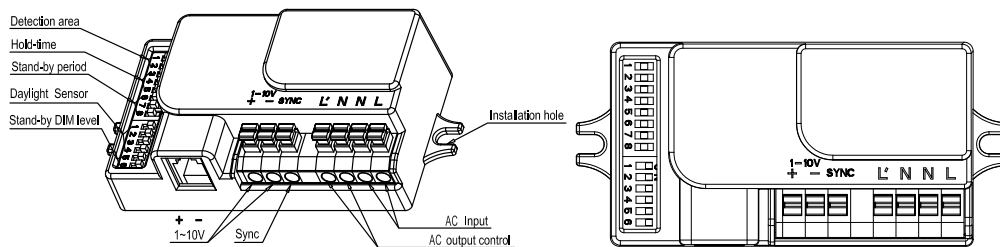

LED Parking Garage Light

KP Series

Installation

Setting:

By selecting the combination on the DIP switch, sensor data can be precisely set for each specific application.

		1	2	
ON ↑ 	I	ON	ON	100%
	II	ON	-	75%
	III	-	ON	50%
	IV	-	-	25%

Detection area

Detection area can be reduced by selecting the combination on the DIP switches to fit precisely each application.

Factory setting: I

		3	4	5	
ON ↑ 	I	ON	ON	ON	5S
	II	-	ON	ON	30S
	III	ON	-	ON	90S
	IV	-	-	ON	3min
	V	ON	ON	-	20min
	VI	-	-	-	+∞

Hold time

Refers to the time period the lamp remains at 100% illumination after no motion detected.

Factory setting: VI

		6	7	8	
ON ↑ 	I	ON	ON	ON	0S
	II	-	ON	ON	5S
	III	ON	-	ON	5min
	IV	-	-	ON	10min
	V	ON	ON	-	30min
	VI	-	ON	-	1h
	VII	-	-	-	+∞

Stand-by period

Refers to the time period the lamp remains at a low light level before it completely switches off in the long absence of people. When set to Disable mode, the low light is maintained until motion is detected.

Factory setting: I

		1	2	
ON ↑ 	I	ON	ON	50%
	II	-	ON	30%
	III	ON	-	20%
	IV	-	-	10%

Stand-by dimming level

The low light level you would like to have after the hold time in the long absence of people.

Factory setting: I

		3	4	5	6	
ON ↑ 	I	ON	ON	ON	ON	5Lux
	II	-	ON	ON	ON	15Lux
	III	ON	-	ON	ON	30Lux
	IV	-	-	ON	ON	50Lux
	V	ON	ON	-	ON	100Lux
	VI	ON	ON	ON	-	150Lux
	VII	-	-	-	-	Disable

Daylight sensor

The sensor can be set to only allow the lamp to illuminate below a defined ambient brightness threshold.

When set to Disable mode, the daylight sensor will switch on the lamp when motion is detected regardless of ambient light level.

100lux, 100lux, 50lux: twilight operation, 10lux, 5lux: darkness operation only.

Note that daylight sensor is active only when lamp totally switches off.

Factory setting: VII

Warning / Avertissement

MIN 75°C SUPPLY CONDUCTOR

THIS PRODUCT MUST BE INSTALLED IN ACCORDANCE WITH THE APPLICABLE INSTALLATION CODE BY A PERSON FAMILIAR WITH THE CONSTRUCTION AND OPERATION OF THE PRODUCT AND THE HAZARDS INVOLVED.

LES FILS D'ALIMENTATION 75°C MIN

CE PRODUIT DOIT ÊTRE INSTALLÉ SELON LE CODE D'INSTALLATION PERTINENT, PAR UNE PERSONNE QUI CONNAÎT BIEN LE PRODUIT ET SON FONCTIONNEMENT AINSI QUE LES RISQUES INHÉRENTS.



LED Parking Garage Light

KP Series



User Notice

- Please turn off the power before installing or changing assembly parts.
- The input voltage and lamps should be matching. Before connecting the power line, please make sure the wiring section is insulated.
- Only professionals should install and disassemble the lamps.

Trouble Shooting

- Flickering light - Turn off the power and turn on again in 3 minutes. If the same phenomena occurs, then call Support.
- Not working - Please check all power connections.

LED Parking Garage Light

KP Series

Application

