

PN KEY ENGINEERING PN

E 4 5 2 X X X X X X X X X X

E - Packing without bag
W - Single Packing

Number of wires:
2 - 2 Wires + Earth

Cable type:
See Table

Head Colour:
G - Grey
N - Black
A - CSA-UL Black
B - CSA-UL Grey

Cable Length in[cm]
050 = 50cm
300 = 300cm
10K = 1000cm

Wiring Configuration:
See sheet 3

Voltage and Led Colour

Red Led:	Green Led:	Yellow Led:
1 = 12V	A = 12V	G = 12V
2 = 24V	B = 24V	H = 24V
3 = 48V	C = 48V	K = 48V
4 = 115V	D = 115V	L = 115V
5 = 230V	E = 230V	M = 230V

Earth PIN location (see insert orientation table):
1 = Double Earth on H6 & H12
2 = Earth on H12
3 = Earth on H3
4 = Double Earth on H3 & H9
6 = Earth on H6
9 = Earth on H9

Type of Gasket and Screw (see sheet 1):
1 = NBR Profile Gasket + Fixing Screw M3x25mm
2 = NBR Flat Gasket + Fixing Screw M3x25mm
3 = Silicone Profile Gasket + Fixing Screw M3x25mm
4 = Silicone Flat Gasket + Fixing Screw M3x25mm
P = NBR Integrated Gasket + Fixing Screw with Washer M3x27mm Assembled on Connector
R = NBR Integrated Gasket + Fixing Screw with Washer M3x27mm NOT Assembled on Connector
T = NBR Profile Gasket + Fixing Screw with Washer M3x27mm

CABLE TYPE	NO. OF WIRES	CROSS SECTION	CABLE O.D.	CABLE JACKET	UL	CSA	STATIC: TEMP. / BENDING RADIUS	DYNAMIC: TEMP. / BENDING RADIUS	SHIELD
A2	3	AWG 20	5.6mm±0.2	PVC BLACK	UL 2661	CSA C22.2	-30°C to +105°C, 10xO.D.	-5°C to +105°C, 15xO.D.	-
A3	3	AWG 18	6.5mm±0.25	PVC BLACK	UL 2661	CSA C22.2	-30°C to +105°C, 10xO.D.	-5°C to +105°C, 15xO.D.	-
B2	3	AWG 20	5.6mm±0.2	PUR BLACK	UL 20668	CSA C22.2	-40°C to +90°C, 5xO.D.	-25°C to +90°C, 10xO.D.	-
B3	3	AWG 18	6.5mm±0.2	PUR BLACK	UL 20668	CSA C22.2	-40°C to +90°C, 5xO.D.	-25°C to +90°C, 10xO.D.	-
F4	3	1mm²	7.1mm+0.2	PVC GREY	-	-	-15°C to +70°C, 10xO.D.	-5°C to +60°C, 15xO.D.	-
I0	3	1mm²	7.6mm±0.2	PVC GREY	-	-	-25°C to +70°C, 10xO.D.	-5°C to +70°C, 15xO.D.	YES
I2	3	0.5mm²	5.5mm+0.3	PVC GREY	-	-	-25°C to +70°C, 10xO.D.	-5°C to +70°C, 15xO.D.	-
I3	3	0.75mm²	6.0mm±0.2	PVC GREY	-	-	-25°C to +70°C, 10xO.D.	-5°C to +70°C, 15xO.D.	-
I4	3	1mm²	7.1mm+0.2	PVC GREY	-	-	-25°C to +70°C, 10xO.D.	-5°C to +70°C, 15xO.D.	-
N2	3	0.5mm²	5.6mm±0.7	PVC BLACK	-	-	-20°C to +70°C, 3xO.D.	-15°C to +70°C, 5xO.D.	-
N3	3	0.75mm²	6.8mm±0.8	PVC BLACK	-	-	-20°C to +70°C, 3xO.D.	-15°C to +70°C, 5xO.D.	-
N4	3	1mm²	7.15mm±0.85	PVC BLACK	-	-	-20°C to +70°C, 3xO.D.	-15°C to +70°C, 5xO.D.	-
P1	3	0.34mm²	5.3mm±0.2	PUR BLACK	-	-	-25°C to +80°C, 10xO.D.	-5°C to +80°C, 15xO.D.	-
P2	3	0.5mm²	5.5mm+0.3	PUR BLACK	-	-	-40°C to +90°C, 7.5xO.D.	-15°C to +90°C, 12.5xO.D.	-
P3	3	0.75mm²	6.5mm±0.2	PUR BLACK	-	-	-40°C to +90°C, 7.5xO.D.	-15°C to +90°C, 12.5xO.D.	-
R4	3	1mm²	7.1mm±0.2	TPR HF BLACK	-	-	-	-	-
Y3	3	0.75mm²	6.5mm±0.2	SILICONE RED	-	-	-60°C to +180°C, 15xO.D.	-	-

Notes:

- Please see excel sheet 1210502000_PDP for currently configured part numbers.
- Drawing is a replacement for: SD-121050-001

SYMBOLS	THIS DRAWING CONTAINS INFORMATION THAT IS PROPRIETARY TO MOLEX ELECTRONIC TECHNOLOGIES, LLC AND SHOULD NOT BE USED WITHOUT WRITTEN PERMISSION		CURRENT REV DESC:		molex
	mm	SCALE 1:1	EC NO: 603741		
	GENERAL TOLERANCES (UNLESS SPECIFIED)		DRWN: APAWLAK01	2018/07/13	
	ANGULAR TOL ± °		CHK'D: RSILLER	2018/08/31	
4 PLACES ±	APPR: RSILLER		2018/08/31	STANDARD E452 DIN FORM A EN 175301-803	
3 PLACES ±	INITIAL REVISION:		PRODUCT CUSTOMER DRAWING		
2 PLACES ±	DRWN: APAWLAK01	2018/07/13	DOCUMENT NUMBER		
1 PLACE ±	APPR: RSILLER	2018/08/31	1210502000		
0 PLACES ±	DRAFT WHERE APPLICABLE MUST REMAIN WITHIN DIMENSIONS		DOC TYPE	DOC PART	REVISION
THIRD ANGLE PROJECTION	DRAWING	SERIES	MATERIAL NUMBER	CUSTOMER	SHEET NUMBER
	A3-SIZE	121050	SEE 1210502000_PDP	GENERAL MARKET	2 OF 3

WIRING DIAGRAMS

ELECTRICAL DIAGRAM 00



ELECTRICAL DIAGRAM A1

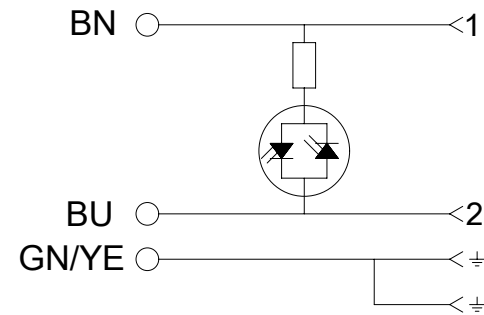

ELECTRICAL DIAGRAM C3

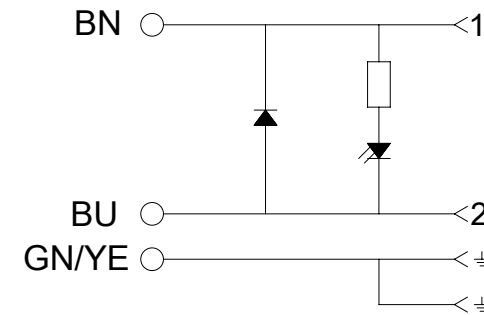

ELECTRICAL DIAGRAM C4

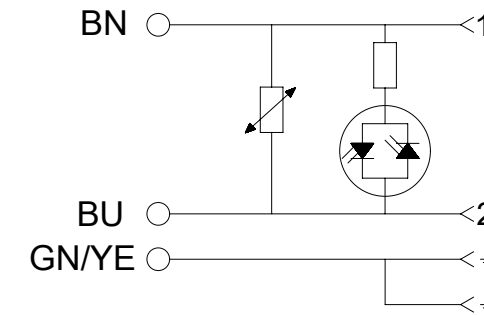

ELECTRICAL DIAGRAM C7



ELECTRICAL DIAGRAM D0

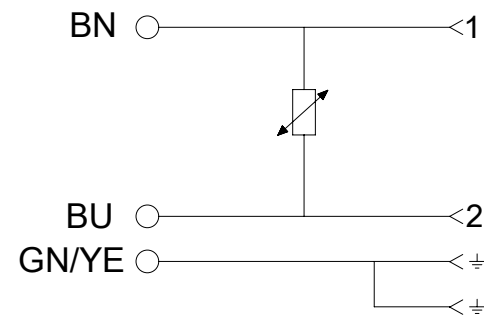

ELECTRICAL DIAGRAM E0

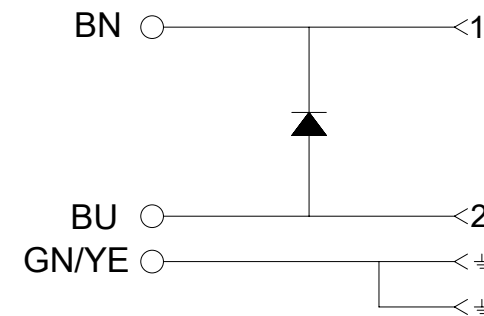

ELECTRICAL DIAGRAM R0

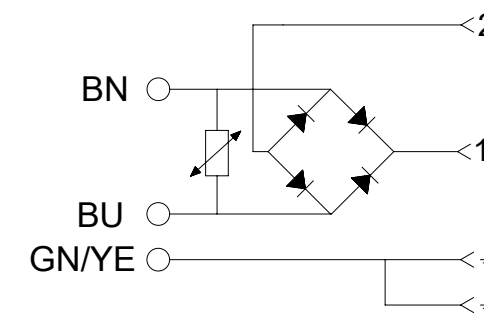

ELECTRICAL DIAGRAM R2



ELECTRICAL DIAGRAM S0

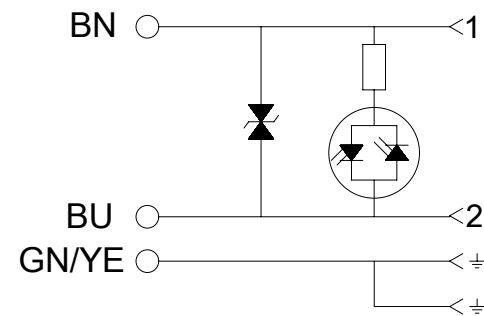

ELECTRICAL DIAGRAM S1

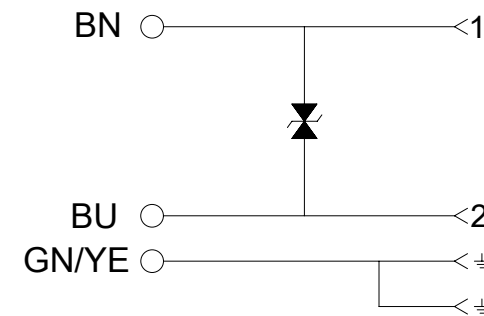

ELECTRICAL DIAGRAM S3

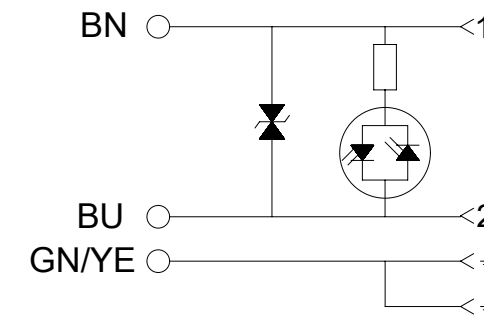

ELECTRICAL DIAGRAM NS



Technical Spec:
 Supply Voltage: See PN KEY
 Max. current: 5A; A1-C4-S0
 1,5A; R2
 Contact Resistance: ≤15milliohms max.
 Operating Temperature:
 with NBR Gasket: -40°C +90°C
 with Silicone: -40°C +125°C

THIS DRAWING CONTAINS INFORMATION THAT IS PROPRIETARY TO MOLEX ELECTRONIC TECHNOLOGIES, LLC AND SHOULD NOT BE USED WITHOUT WRITTEN PERMISSION									
SYMBOLS	DIMENSION UNITS	SCALE	CURRENT REV DESC:						
▽ = 0	mm	1:1	molex STANDARD E452 DIN FORM A EN 175301-803 PRODUCT CUSTOMER DRAWING DOCUMENT NUMBER: 1210502000 DOC TYPE: PSD DOC PART: 000 REVISION: A MATERIAL NUMBER: SEE 1210502000_PDP CUSTOMER: GENERAL MARKET SHEET NUMBER: 3 OF 3						
▽ = 0	GENERAL TOLERANCES (UNLESS SPECIFIED)								
▽ = 0	ANGULAR TOL ± °								
▽ = 0	4 PLACES	±							
▽ = 0	3 PLACES	±							
▽ = 0	2 PLACES	±	EC NO: 603741						
▽ = 0	1 PLACE	±	DRWN: APWLAK01 2018/07/13						
▽ = 0	0 PLACES	±	CHK'D: RSILLER 2018/08/31						
☒ = 0	DRAFT WHERE APPLICABLE MUST REMAIN WITHIN DIMENSIONS		APPR: RSILLER 2018/08/31						
▽ = 0	THIRD ANGLE PROJECTION		DRAWING		SERIES		MATERIAL NUMBER		
		A3-SIZE		121050		CUSTOMER			SHEET NUMBER



DOUBLE EARTH ON 6H & 12H E452XXXXXX1XXXX	EARTH PIN ON 12H E452XXXXXX2XXXX	EARTH PIN ON 6H E452XXXXXX6XXXX
DOUBLE EARTH ON 3H & 9H E452XXXXXX4XXXX	EARTH PIN ON 3H E452XXXXXX3XXXX	EARTH PIN ON 9H E452XXXXXX9XXXX

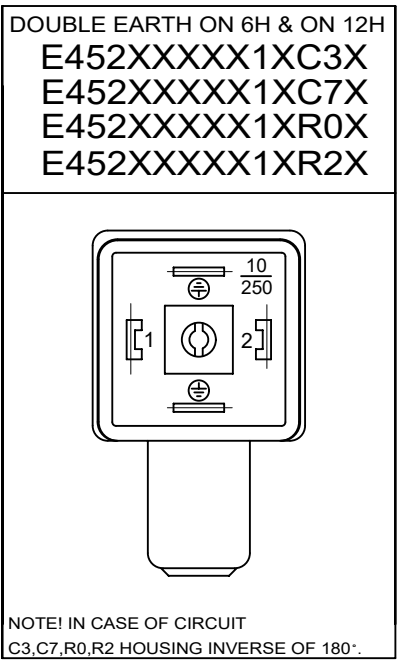

Table of length tolerances [mm]

Over	Up to and including	Tolerance (+)
0	1000	±20
1000	3000	±30
3000	5000	±40
5000	10000	±50
10000	15000	±100
15000	20000	±150
20000		±L/100

WIRING CONFIGURATION

ELECTRICAL DIAGRAM R0	ELECTRICAL DIAGRAM C4	ELECTRICAL DIAGRAM S0
ELECTRICAL DIAGRAM S3	ELECTRICAL DIAGRAM A1	ELECTRICAL DIAGRAM C3
ELECTRICAL DIAGRAM E0	ELECTRICAL DIAGRAM R2	ELECTRICAL DIAGRAM C7
ELECTRICAL DIAGRAM S1	ELECTRICAL DIAGRAM 00	

NOTES:
1. FOR HARNESS WITH GROUND ONLY IN:
3H,6H,9H or 12H PIN 3 IS N/C.

THIS DRAWING CONTAINS INFORMATION THAT IS PROPRIETARY TO MOLEX ELECTRONIC TECHNOLOGIES, LLC AND SHOULD NOT BE USED WITHOUT WRITTEN PERMISSION

DIMENSION UNITS: mm	SCALE: NTS	CURRENT REV DESC: REVISION CREATED FOR REMOVING PRE-RELEASE STAMP	molex		
GENERAL TOLERANCES (UNLESS SPECIFIED)					
4 PLACES ±	MM INCH	EC NO: 714567	E452XXXXXXXXXX DIN FORM A EN 175301-803		
3 PLACES ±		DRWN: SUGEEB 2022/07/18	PRODUCT CUSTOMER DRAWING		
2 PLACES ±		CHK'D: GGA 2022/07/19	DOCUMENT NUMBER: SD-121050-001		
1 PLACE ±		APPR: GGA 2022/07/19	DOC TYPE: PSD		
0 PLACES ±		INITIAL REVISION:	DOC PART: 001		
ANGULAR TOL ± °		DRWN: JMARSZALEK 2012/08/27	REVISION: E1		
DRAFT WHERE APPLICABLE MUST REMAIN WITHIN DIMENSIONS	FIRST ANGLE PROJECTION	APPR: MDYSZEWSKA 2012/08/20	MATERIAL NUMBER: SEE TABLE	CUSTOMER: GENERAL MARKET	SHEET NUMBER: 1 OF 41

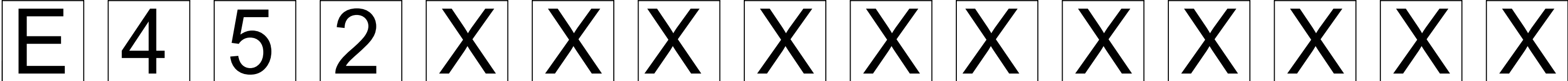

E - Packing without bags
 W - Single packing
 Q - Quick packing

NUMBER OF WIRES:
 1=2 WIRES
 2=2 WIRES + EARTH
 3=3 WIRES + EARTH

CABLE TYPE
 SEE SHEET 3 - TABLE 1

CABLE CROSS SECTION AREA
 SEE SHEET 3 - TABLE 2

HEAD COLOUR:
 N=BLACK;
 A=CSA-UL BLACK;
 B=CSA-UL GREY.

CABLE LENGTH IN CM
 Eg.:050=50 CM, 300=300 CM, 10K=1000 CM.

EARTH PIN LOCATION:
 1=DOUBLE EARTH ON 6H AND 12H,
 2=EARTH ON 12H,
 6=EARTH ON 6H.

TYPE OF GASKET AND SCREW:
 1=NBR PROFILE GASKET + FIXING SCREWS (M3x25 mm).
 2=NBR FLAT GASKET + FIXING SCREW (M3x25 mm).
 3=SILICONE PROFILE GASKET + FIXING SCREW (M3x25 mm).
 4=SILICON FLAT GASKET + FIXING SCREW (M3x25 mm).
 P=INTEGRATED GASKET ASSEMBLED + FIXING SCREW WITH GROMMET ASSEMBLED ON CONNECTOR (M3x27 mm).
 R=INTEGRATED GASKET + FIXING SCREW + GROMMET (M3x27 mm).
 T=PROFILE GASKET + FIXING SCREW + GROMMET (M3x27 mm).

INTERNAL CIRCUIT
 WIRING CONFIGURATION

VOLTAGE AND LED COLOUR:

1= 12V	} RED LED	A= 12V	} GREEN LED	G= 12V	} YELLOW LED
2= 24V		B= 24V		H= 24V	
3= 48V		C= 48V		K= 48V	
4= 115V		D= 115V		L= 115V	
5= 230V		E= 230V		M= 230V	

THIS DRAWING CONTAINS INFORMATION THAT IS PROPRIETARY TO MOLEX ELECTRONIC TECHNOLOGIES, LLC AND SHOULD NOT BE USED WITHOUT WRITTEN PERMISSION													
DIMENSION UNITS		SCALE		CURRENT REV DESC: REVISION CREATED FOR REMOVING PRE-RELEASE STAMP									
mm		NTS											
GENERAL TOLERANCES (UNLESS SPECIFIED)				EC NO: 714567		DRWN: SUGEEB		2022/07/18		E452XXXXXXXXXX			
				CHK'D: GGA		2022/07/19		DIN FORM A EN 175301-803		PRODUCT CUSTOMER DRAWING			
				APPR: GGA		2022/07/19		DOCUMENT NUMBER					
4 PLACES ±				INITIAL REVISION:		DRWN: JMARSZALEK		2012/08/27		SD-121050-001			
3 PLACES ±				APPR: MDYSZEWSKA		2012/08/20		DOC TYPE		PSD			
2 PLACES ±				DRAFT WHERE APPLICABLE MUST REMAIN WITHIN DIMENSIONS		FIRST ANGLE PROJECTION		DRAWING		SERIES			
1 PLACE ±				A3-SIZE		121050		CUSTOMER		GENERAL MARKET			
0 PLACES ±				SEE TABLE		2 OF 41		REVISION		E1			
ANGULAR TOL ± °													

TABLE 2 - CABLES

Molex PN Raw cable	Cable type	Cable code	Wires no.	Cross Section	Jacket material	Jacket color	Diameter Ø [mm]	Wire colors
1210180080	I	0	3	1 mm²	PVC CEI 2022 II O.R.	Grey	6.4±0.2	BN, BU, GN/YE
1210180467	A	2	2	20 AWG	PVC CSA/UL 2661	Black	5.4±0.2	BN, BU
1210180128	A	2	3	20 AWG	PVC CSA/UL 2661	Black	5.6±0.2	BN, BU, GN/YE
1210180394	A	2	4	20 AWG	PVC CSA/UL 2661	Black	6.2±0.25	BN, BU, BK, GN/YE
1210180297	B	2	2	20 AWG	PUR CSA/UL 20668	Black	5.6±0.2	BN, BU
1210180126	B	2	3	20 AWG	PUR CSA/UL 20668	Black	5.6±0.2	BN, BU, GN/YE
1210180387	B	2	4	20 AWG	PUR CSA/UL 20668	Black	6.3±0.2	BN, BU, BK, GN/YE
1210180122	D	2	3	0.5 mm²	PVC CEI 20-20	Grey	5.5±0.2	BN, BU, GN/YE
1210180047	I	2	2	0.5 mm²	PVC CEI 2022 II O.R.	Grey	5.5+0.3/-0	BN, BU
1210180284	I	2	3	0.5 mm²	PVC CEI 2022 II O.R.	Grey	5.5+0.3/-0	BN, BU, GN/YE
1210180146	I	2	4	0.5 mm²	PVC CEI 2022 II O.R.	Grey	6.5±0.2	BN, BU, BK, GN/YE
1210180177	I	2	5	0.5 mm²	PVC CEI 2022 II O.R.	Grey	7.0 +0.3/-0	BN, BU, BK, WH, GN/YE
1210180022	N	2	2	0.5 mm²	PVC H03VV-F	Black	5.2±0.2	BN, BU
1202092753	N	2	3	0.5 mm²	PVC H03VV-F	Black	5.5±0.2	BN, BU, GN/YE
1210180153	N	2	4	0.5 mm²	PVC H03VV-F	Black	5.9±0.3	BN, BU, BK, GN/YE
1210180046	P	2	2	0.5 mm²	PUR - BLEND	Black	5.5±0.2	BN, BU
1202092439	P	2	3	0.5 mm²	PUR - BLEND	Black	5.5 +0.3/-0	BN, BU, GN/YE
1210180302	P	2	4	0.5 mm²	PUR - BLEND	Black	6.5±0.2	BN, BU, BK, GN/YE
1202092215	P	2	5	0.5 mm²	PUR - BLEND	Black	7+0.3/-0.1	BN, BU, BK, WH, GN/YE
1210180409	A	3	2	18 AWG	PVC CSA/UL 2661	Black	6.2±0.25	BN, BU
1210180129	A	3	3	18 AWG	PVC CSA/UL 2661	Black	6.5±0.25	BN, BU, GN/YE
1210180159	A	3	4	18 AWG	PVC CSA/UL 2661	Black	7.0+0.3/-0	BN, BU, BK, GN/YE
1210180464	A	3	5	18 AWG	PVC CSA/UL 2661	Black	7.8±0.25	BN, BU, BK, WH, GN/YE
1210180351	B	3	2	18 AWG	PUR CSA/UL 20668	Black	6.2±0.2	BN, BU
1210180127	B	3	3	18 AWG	PUR CSA/UL 20668	Black	6.5±0.2	BN, BU, GN/YE
1210180160	B	3	4	18 AWG	PUR CSA/UL 20668	Black	7±0.2	BN, BU, BK, GN/YE
1210180463	B	3	5	18 AWG	PUR CSA/UL 20668	Black	7.8±0.25	BN, BU, BK, WH, GN/YE
1210180073	D	3	3	0.75 mm²	PVC CEI 20-20	Grey	6.5±0.2	BN, BU, GN/YE
1210180145	D	3	4	0.75 mm²	PVC CEI 20-20	Grey	7.1±0.2	BN, BU, BK, GN/YE
1202098206	I	3	2	0.75 mm²	PVC CEI 2022 II O.R.	Grey	5.5±0.2	BK1, BK2
1210180120	I	3	3	0.75 mm²	PVC CEI 2022 II O.R.	Grey	6.0±0.2	BK1, BK2, BK3
1210180143	I	3	4	0.75 mm²	PVC CEI 2022 II O.R.	Grey	7.0±0.2	BN, BU, BK, GN/YE
1210180032	N	3	2	0.75 mm²	PVC H05VV-F	Black	6.2±0.2	BN, BU
1210180069	N	3	3	0.75 mm²	PVC H05VV-F	Black	6.5±0.2	BN, BU, GN/YE
1210180144	N	3	4	0.75 mm²	PVC H05VV-F	Black	7.1±0.2	BN, BU, BK, GN/YE
1210180174	N	3	5	0.75 mm²	PVC H05VV-F	Black	8.0+0.2/-0	BN, BU, BK, GY, GN/YE
1202094190	P	3	2	0.75 mm²	PUR - BLEND	Black	6.5±0.2	BN, BU
1210180071	P	3	3	0.75 mm²	PUR - BLEND	Black	6.5±0.2	BN, BU, GN/YE
1210180152	P	3	4	0.75 mm²	PUR - BLEND	Black	7.0±0.2	BN, BU, BK, GN/YE

TABLE 2 - CABLES

Molex PN Raw cable	Cable type	Cable code	Wires no.	Cross Section	Jacket material	Jacket color	Diameter Ø [mm]	Wire colors
1210180384	R	3	3	0.75 mm²	TPR HAL. FREE	Black	6.5±0.2	BN, BU, GN/YE
1210180094	T	3	3	0.75 mm²	PUR CSA/UL 20668	Yellow	6.5±0.2	BN, BU, GN/YE
1210180309	Y	3	3	0.75 mm²	SILICONE RUBBER	Red	6.5±0.2	BN, BU, GN/YE
1210180081	F	4	3	1 mm²	PVC CNOMO	Grey	7.1+0.2/-0	BK1, BK2, GN/YE
1210180042	I	4	2	1 mm²	PVC CEI 2022 II O.R.	Grey	7.1+0.2/-0	BN, BU
1210180079	I	4	3	1 mm²	PVC CEI 2022 II O.R.	Grey	7.1+0.2/-0	BN, BU, GN/YE
1210180036	N	4	2	1 mm²	PVC H05VV-F	Black	6.5±0.2	BN, BU
1210180082	N	4	3	1 mm²	PVC H05VV-F	Black	6.9±0.2	BN, BU, GN/YE
1210180117	R	4	3	1 mm²	TPR HAL. FREE	Black	7.1±0.2	BN, BU, GN/YE
1210180085	N	5	3	1.5 mm²	PVC H05VV-F	Black	7.9±0.2	BN, BU, GN/YE
1210180313	I	6	2	0.35 mm²	PVC CEI 2011	Grey	4.8±0.2	BN, WH
1210180149	I	9	4	0.75 mm²	PVC CEI 2022 II	Grey	7.3±0.2	BN, BU, BK, GN/YE

TABLE 1 - CABLES TYPE

Code	Cable types	Features	Cable type Cross section
N	PVC	Application general purpose cable which has good resistance to water, but usually poor oil resistance.	N2=0.5 mm2 N3=0.75 mm2 N4=1 mm2
I	CEI	Approved to IEC 332-2A, flame retardant and self extinguishing. Limited resistant to mineral oils.	I2=0.5 mm2 I3=0.75 mm2 I4=1 mm2
P	PUR	Offer good resistance to oil and chemicals. Can swell when constantly immersed in water.	P2=0.5 mm2 P3=0.75 mm2 P4=1 mm2
A	PVC CSA-UL	Approved to CSA-UL 2661, application general purpose cable which has good resistance to water, but usually poor oil resistance.	A2=20 AWG A3=18 AWG
B	PUR CSA-UL	Approved to CSA-UL 20668, very good resistance to oil and chemicals.	B2=20 AWG B3=18 AWG

THIS DRAWING CONTAINS INFORMATION THAT IS PROPRIETARY TO MOLEX ELECTRONIC TECHNOLOGIES, LLC AND SHOULD NOT BE USED WITHOUT WRITTEN PERMISSION									
DIMENSION UNITS		SCALE		CURRENT REV DESC: REVISION CREATED FOR REMOVING PRE-RELEASE STAMP					
mm		NTS							
GENERAL TOLERANCES (UNLESS SPECIFIED)				EC NO: 714567		2022/07/18		E452XXXXXXXXXX	
				DRWN: SUGEEB		2022/07/19		DIN FORM A EN 175301-803	
				CHK'D: GGA		2022/07/19		PRODUCT CUSTOMER DRAWING	
				APPR: GGA		2022/07/19		DOCUMENT NUMBER	
				INITIAL REVISION:				SD-121050-001	
				DRWN: JMARSZALEK		2012/08/27		DOC TYPE DOC PART REVISION	
				APPR: MDYSZEWSKA		2012/08/20		PSD 001 E1	
DRAFT WHERE APPLICABLE MUST REMAIN WITHIN DIMENSIONS				FIRST ANGLE PROJECTION		DRAWING		SERIES	
						A3-SIZE		121050	
				MATERIAL NUMBER		CUSTOMER		SHEET NUMBER	
				SEE TABLE		GENERAL MARKET		3 OF 41	

TABLE 3 - PART LIST

Pos.	Molex PN:	Engineering No.:
1	1210400514	E452N3N10012000
2	1210400515	E452N3N30012000
3	1210400516	E452N3N50012000
4	1210400517	E452P3N10012000
5	1210400519	E452P3N30012000
6	1210400755	E452N3N2001P000
7	1210400810	E452N3N15K12000
8	1210400861	E452N3N10011000
9	1210400896	E452A2A80012000
10	1210400897	E452A2A90012000
11	1210400898	E452A2A70012000
12	1210400899	E452A2A40012000
13	1210400900	E452A2A50012000
14	1210400901	E452N3N13K12000
15	1210400909	E452A2A60012000
16	1210400957	E452N3N20012000
17	1210401237	W452P3N30012000
18	1210401242	W452N3N50012000
19	1210401265	W452N3N30012000
20	1210401291	W452N3N10012000
21	1210500294	E452A2A20011C4H
22	1210500295	E452A3A10011C42
23	1210500297	E452A3A30011C44
24	1210500298	E452A3A30011C4H
25	1210500299	E452A3A30012000
26	1210500301	E452A3A30012C4H
27	1210500302	E452A3A50012C4L
28	1210500311	E452B3A30012C4H
29	1210500312	E452B3A30012C4L
30	1210500313	E452B3A50012C4H
31	1210500314	E452B8N10012000
32	1210500339	E452F4N10K11S3B
33	1210500344	E452F4N20011S3B
34	1210500352	E452F4N50011S3B
35	1210500362	E452I0N20011C42
36	1210500375	E452I2N10011C4H
37	1210500376	E452I2N10011C72
38	1210500384	E452I2N20011C3H
39	1210500385	E452I2N20011C4H
40	1210500388	E452I2N30011C32

Pos.	Molex PN:	Engineering No.:
41	1210500389	E452I2N30011C3H
42	1210500390	E452I2N30011C42
43	1210500392	E452I2N30011C4H
44	1210500393	E452I2N30011C4L
45	1210500394	E452I2N30011C4M
46	1210500398	E452I2N50011C42
47	1210500399	E452I2N50011C4H
48	1210500407	E452I4G30011C4B
49	1210500408	E452I4G30011C4H
50	1210500414	E452I4G40011C4H
51	1210500417	E452I4G50011C4H
52	1210500424	E452I4N10011C42
53	1210500428	E452I4N10011C4H
54	1210500434	E452I4N10K11C4H
55	1210500435	E452I4N10K11C4L
56	1210500443	E452I4N15K11C4H
57	1210500448	E452I4N20011C3H
58	1210500452	E452I4N20011C4H
59	1210500455	E452I4N20011C7H
60	1210500465	E452I4N30011A1H
61	1210500467	E452I4N30011C3H
62	1210500468	E452I4N30011C42
63	1210500469	E452I4N30011C44
64	1210500473	E452I4N30011C4H
65	1210500474	E452I4N30011C4L
66	1210500475	E452I4N30011C4M
67	1210500478	E452I4N30011R2H
68	1210500479	E452I4N30011R2L
69	1210500480	E452I4N30011R2M
70	1210500481	E452I4N30011S0H
71	1210500486	E452I4N35011C45
72	1210500489	E452I4N40011C42
73	1210500492	E452I4N40011C4H
74	1210500498	E452I4N50011C3H
75	1210500499	E452I4N50011C42
76	1210500504	E452I4N50011C4H
77	1210500505	E452I4N50011C4L
78	1210500506	E452I4N50011C4M
79	1210500510	E452I4N50011R2L
80	1210500511	E452I4N50011S0H

Pos.	Molex PN:	Engineering No.:
81	1210500514	E452I4N55011C72
82	1210500515	E452I4N60011C42
83	1210500520	E452I4N70011R2H
84	1210500522	E452I4N80011C4H
85	1210500524	E452I8N50011C4H
86	1210500548	E452N3N10011A11
87	1210500549	E452N3N10011C42
88	1210500551	E452N3N10011C45
89	1210500552	E452N3N10011C4B
90	1210500554	E452N3N10011C4H
91	1210500556	E452N3N10011R2H
92	1210500558	E452N3N10012C4H
93	1210500559	E452N3N10012C4L
94	1210500560	E452N3N10022C4L
95	1210500562	E452N3N10K11C42
96	1210500569	E452N3N10K11S02
97	1210500572	E452N3N10K11S0H
98	1210500575	E452N3N10K12C4H
99	1210500576	E452N3N10K12C4L
100	1210500582	E452N3N15011A11
101	1210500583	E452N3N15011A12
102	1210500584	E452N3N15011A15
103	1210500585	E452N3N15011C32
104	1210500591	E452N3N15012C4H
105	1210500594	E452N3N15022C4L
106	1210500599	E452N3N15K12C4H
107	1210500601	E452N3N20011A11
108	1210500602	E452N3N20011A12
109	1210500603	E452N3N20011A14
110	1210500606	E452N3N20011A1H
111	1210500612	E452N3N20011C42
112	1210500620	E452N3N20011C4H
113	1210500621	E452N3N20011C4L
114	1210500624	E452N3N20011R05
115	1210500627	E452N3N20011R2M
116	1210500636	E452N3N25011C42
117	1210500638	E452N3N25011C4H
118	1210500644	E452N3N30011A1H
119	1210500648	E452N3N30011C32
120	1210500649	E452N3N30011C41

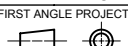
Pos.	Molex PN:	Engineering No.:
121	1210500650	E452N3N30011C42
122	1210500651	E452N3N30011C44
123	1210500652	E452N3N30011C45
124	1210500657	E452N3N30011C4H
125	1210500658	E452N3N30011C4L
126	1210500659	E452N3N30011C4M
127	1210500662	E452N3N30011R2H
128	1210500666	E452N3N30011S0D
129	1210500673	E452N3N30012C4H
130	1210500674	E452N3N30012C4L
131	1210500685	E452N3N35011A11
132	1210500689	E452N3N40011A12
133	1210500690	E452N3N40011C42
134	1210500691	E452N3N40011C44
135	1210500692	E452N3N40011C45
136	1210500693	E452N3N40011C4H
137	1210500696	E452N3N50011A1B
138	1210500702	E452N3N50011C42
139	1210500703	E452N3N50011C44
140	1210500705	E452N3N50011C4B
141	1210500707	E452N3N50011C4D
142	1210500708	E452N3N50011C4E
143	1210500709	E452N3N50011C4H
144	1210500711	E452N3N50011S02
145	1210500712	E452N3N50011S0D
146	1210500713	E452N3N50011S0H
147	1210500714	E452N3N50012C44
148	1210500715	E452N3N50012C4H
149	1210500716	E452N3N50012C4L
150	1210500722	E452N3N65021C42
151	1210500730	E452P2N04011C4H
152	1210500735	E452P2N07511C32
153	1210500737	E452P2N10011C4H
154	1210500739	E452P2N10K11C4H
155	1210500741	E452P2N10K11S0H
156	1210500742	E452P2N11011C4H
157	1210500747	E452P2N16011C4H
158	1210500748	E452P2N20011C4H
159	1210500755	E452P2N30011C4L
160	1210500759	E452P2N30011S0H

THIS DRAWING CONTAINS INFORMATION THAT IS PROPRIETARY TO MOLEX ELECTRONIC TECHNOLOGIES, LLC AND SHOULD NOT BE USED WITHOUT WRITTEN PERMISSION									
DIMENSION UNITS		SCALE		CURRENT REV DESC: REVISION CREATED FOR REMOVING PRE-RELEASE STAMP				 E452XXXXXXXXXX DIN FORM A EN 175301-803	
mm		NTS							
GENERAL TOLERANCES (UNLESS SPECIFIED)				EC NO: 714567		2022/07/18		PRODUCT CUSTOMER DRAWING	
				DRWN: SUGEEB		2022/07/19			
				CHK'D: GGA		2022/07/19		DOCUMENT NUMBER	
				APPR: GGA		2022/07/19			
				INITIAL REVISION:				SD-121050-001 PSD 001 E1	
				DRWN: JMARSZALEK		2012/08/27			
				APPR: MDYSZEWSKA		2012/08/20		DOC TYPE DOC PART REVISION	
DRAFT WHERE APPLICABLE MUST REMAIN WITHIN DIMENSIONS				FIRST ANGLE PROJECTION		DRAWING		SHEET NUMBER	
						A3-SIZE		4 OF 41	

TABLE 3 - PART LIST

Pos.	Molex PN:	Engineering No.:
161	1210500764	E452P2N50011C42
162	1210500766	E452P2N50011C4B
163	1210500769	E452P2N50011C4H
164	1210500770	E452P2N50011C4L
165	1210500776	E452P2N50011S0H
166	1210500787	E452P3N05011S0B
167	1210500791	E452P3N10012C4H
168	1210500792	E452P3N10012C4L
169	1210500795	E452P3N10K11S0H
170	1210500801	E452P3N15011S0H
171	1210500803	E452P3N20011C42
172	1210500807	E452P3N30011C3H
173	1210500810	E452P3N30011C4H
174	1210500812	E452P3N30011S0B
175	1210500814	E452P3N30011S0H
176	1210500815	E452P3N30012C4H
177	1210500816	E452P3N30012C4L
178	1210500817	E452P3N50011C3H
179	1210500819	E452P3N50011C4H
180	1210500821	E452P3N50011S02
181	1210500822	E452P3N50011S0B
182	1210500823	E452P3N50011S0H
183	1210500824	E452P3N50012000
184	1210500826	E452P3N50012C4H
185	1210500827	E452P3N50012C4L
186	1210501560	E452A2A10012000
187	1210501561	E452N3N50011C4M
188	1210501563	E452A2A30012000
189	1210501569	E452I2N15011C7H
190	1210501577	E452N3N50011C4L
191	1210501578	E452B3A50012C4L
192	1210501581	E452P3N07011C4H
193	1210501584	E452I4G60011C4H
194	1210501587	E452P3N50011R2E
195	1210501591	E452A3A50012C4H
196	1210501607	E452N3N10013C4H
197	1210501608	E452N3N50013C4H
198	1210501609	E452N2N15011E05
199	1210501610	E452P2N30011C4H
200	1210501611	E452A3A10K12C4H

Pos.	Molex PN:	Engineering No.:
201	1210501612	E452I4G20011C4H
202	1210501624	E452A3A30012C4L
203	1210501632	E452P2N20011C42
204	1210501647	E452P3N20011S02
205	1210501656	E452A2A50012C4H
206	1210501657	E452P3N20011C44
207	1210501664	E452P3N10011C4H
208	1210501674	E452A3A20011C44
209	1210501690	E452N2N50011C4H
210	1210501698	E452I4N20011C3B
211	1210501720	E452I4N80011C72
212	1210501726	E452A3A20011C45
213	1210501733	E452P3N50011A1H
214	1210501735	E452N2N30011A12
215	1210501737	E452N2N10011R2H
216	1210501749	E452A2A15011C4H
217	1210501764	E452N3N06011A12
218	1210501766	E452N3N10011A12
219	1210501780	E452A3A30011R2L
220	1210501781	E452B3A30011C4H
221	1210501795	E452I2N10K11C4H
222	1210501799	E452N2N30011A1M
223	1210501800	E452N2N30011A1D
224	1210501801	E452A3A50012000
225	1210501813	E452I4N60011C4H
226	1210501840	E452A2A30011C32
227	1210501844	E452I4N15011C4H
228	1210501867	E452N3N10011C4M
229	1210501874	E452A3A20011A1M
230	1210501878	E452N3N1001PC4H
231	1210501879	E452A3A30011C4L
232	1210501882	E452B3A30022000
233	1210501887	E452A3A50011C7H
234	1210501888	E452A3A20011C7H
235	1210501889	E452P3N3001PS0H
236	1210501890	E452P3N5001PS0H
237	1210501891	E452P3N5001PC4M
238	1210501892	E452B3A10012000
239	1210501916	E452I2N50011C44
240	1210501921	E452N2N20091C3H

Pos.	Molex PN:	Engineering No.:
241	1210501932	E452I4G40011S0H
242	1210501941	E452N3N3001PS0H
243	1210501942	E452N3N1001PS0H
244	1210501960	E452I4N70011R2L
245	1210501962	E452P3N3001PC4H
246	1210501966	E452A3A50012C3H
247	1210501968	E452N3N2001PC42
248	1210501973	E452I4N50011C3B
249	1210501998	E452P3N1001PC4H
250	1210501999	E452P3N3001PC45
251	1210502000	E452I4N50011S02
252	1210502004	E452A3A50011S0H
253	1210502007	E452A2A15011S0H
254	1210502008	E452A2A50011S0H
255	1210502018	E452N3N25011S0H
256	1210502022	E452A3A10K12000
257	1210502024	E452A3A50011C44
258	1210502034	E452N2N30011A14
259	1210502035	E452A3A10012C4L
260	1210502038	E452N3N5001PC4H
261	1210502039	E452N3N3001PC4H
262	1210502043	E452A2A20011S0H
263	1210502044	E452A2A30011S0H
264	1210502050	E452N3N10K11C4L
265	1210502052	E452P3N2001PC3H
266	1210502068	E452T3A30011C4H
267	1210502072	E452P3N1501PS0H
268	1210502077	E452I2N40011C42
269	1210502080	E452I4N60011C32
270	1210502083	E452N2N30011A1H
271	1210502084	E452N2N30011C3H
272	1210502091	E452T3A20011C4H
273	1210502100	E452N3N20011C41
274	1210502115	E452T3A10011C4H
275	1210502128	E452I4N35011A1B
276	1210502134	E452N3N10011C3G
277	1210502137	E452N3N5001RA1H
278	1210502142	E452N3N3001RC4H
279	1210502171	E452A2A10011S0H
280	1210502177	E452N2N30011C42

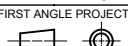
Pos.	Molex PN:	Engineering No.:
281	1210502178	E452N2N30011C44
282	1210502180	E452I4N10K11C3H
283	1210502190	E452I2N10014A1G
284	1210502194	E452F4N5001RC4E
285	1210502213	E452N2N30011R2M
286	1210502214	E452N2N15041C4H
287	1210502219	E452I4N50011R2M
288	1210502223	E452P3N5001PC4H
289	1210502232	E452N2N30041C4H
290	1210502233	E452N3N5001PS0H
291	1210502244	E452N3N20011R2H
292	1210502247	E452N2N5001RA1H
293	1210502248	E452N2N10K1RA1H
294	1210502256	E452T3A06011C4H
295	1210502258	E452A3A30012C4M
296	1210502259	E452A3A20011C42
297	1210502262	E452N3N40011R2M
298	1210502278	E452N3N1001TR2H
299	1210502281	E452N2N30011C4M
300	1210502283	E452T3A60011C4H
301	1210502289	E452I4N5001PC4H
302	1210502309	E452N3N4001PC4H
303	1210502311	E452A3A10K11S0H
304	1210502314	E452N3N2001PR2M
305	1210502317	E452N2N10011A12
306	1210502318	E452N3N2001PC3H
307	1210502328	E452B2A30011A15
308	1210502334	E452A3A30011C42
309	1210502335	E452P3N2001PC4H
310	1210502341	E452N3N10K11C4H
311	1210502346	E452N2N10K12C4H
312	1210502352	E452N3N50012S02
313	1210502353	E452A3A30022000
314	1210502357	E452B3A50011C4H
315	1210502359	E452I2N50011C3H
316	1210502363	E452A2A10K11S0H
317	1210502375	E452N2N10011R24
318	1210502389	E452N3N55021A12
319	1210502396	E452P3N10K11C4H
320	1210502404	E452P2N20011S0B

THIS DRAWING CONTAINS INFORMATION THAT IS PROPRIETARY TO MOLEX ELECTRONIC TECHNOLOGIES, LLC AND SHOULD NOT BE USED WITHOUT WRITTEN PERMISSION									
DIMENSION UNITS		SCALE		CURRENT REV DESC: REVISION CREATED FOR REMOVING PRE-RELEASE STAMP				 E452XXXXXXXXXX DIN FORM A EN 175301-803	
mm		NTS							
GENERAL TOLERANCES (UNLESS SPECIFIED)									
		MM		INCH					
4 PLACES		±		±					
3 PLACES		±		±					
2 PLACES		±		±					
1 PLACE		±		±					
0 PLACES		±		±					
ANGULAR TOL				± °					
DRAFT WHERE APPLICABLE MUST REMAIN WITHIN DIMENSIONS				FIRST ANGLE PROJECTION		DRAWING		SERIES	
						A3-SIZE		121050	
DOCUMENT STATUS		P1		RELEASE DATE		2022/07/19		09:04:35	
		9		8		7		6	
		5		4		3		2	
		1							

TABLE 3 - PART LIST

Pos.	Molex PN:	Engineering No.:
321	1210502411	E452P3N10011R2E
322	1210502413	E452P2N50011C4M
323	1210502414	E452A3A50021000
324	1210502416	E452N2N20011C4H
325	1210502417	E452R4N2001PC4M
326	1210502418	E452R4N2001PR2E
327	1210502419	E452N3N8001RA1H
328	1210502438	E452I4N70011A1L
329	1210502441	E452I2N20011C7H
330	1210502447	E452I4N15011R22
331	1210502471	E452N2N20011C42
332	1210502474	E452N3N15011C3A
333	1210502475	E452N3N25011S0B
334	1210502476	E452I4N90011C3H
335	1210502479	E452Y3N40011C42
336	1210502488	E452P3N30011C4M
337	1210502492	E452Y3N20011A14
338	1210502495	E452A3A30012C4G
339	1210502497	E452N3N4001RA1G
340	1210502501	E452B3A30012C3H
341	1210502505	E452P2N15K11C4H
342	1210502507	E452N3N20014S04
343	1210502510	E452N3N1001RC4H
344	1210502518	E452A3A50011R2L
345	1210502520	E452N3N2001PS02
346	1210502522	E452I4N60011C3H
347	1210502523	E452P2N40011C3B
348	1210502524	E452P2N20011C3B
349	1210502525	E452Y3N20011A12
350	1210502526	E452P3N0751PC4M
351	1210502527	E452I4N15011A1H
352	1210502530	E452I4G40011C42
353	1210502531	E452I4G50011C42
354	1210502539	E452N3N12011C4M
355	1210502540	E452A2A11K12000
356	1210502543	E452P2N50011C4G
357	1210502548	E452I4G10K11C4H
358	1210502549	E452I4G15K11C4H
359	1210502551	E452N2N20011E05
360	1210502554	E452N3N5001PS02

Pos.	Molex PN:	Engineering No.:
361	1210502555	E452P3N40011C3H
362	1210502561	E452N2N20011A11
363	1210502564	E452N3N10K1RA1H
364	1210502565	E452Y3N20011C42
365	1210502567	E452Y3N40011A12
366	1210502568	E452B2B10011A12
367	1210502572	E452N3N05011C31
368	1210502575	E452B2A1502TC32
369	1210502577	E452N3N0501RC4B
370	1210502578	E452N3N12K1RA1H
371	1210502579	E452I4G80011C4H
372	1210502581	E452N2N20011A1H
373	1210502584	E452N3N03011A12
374	1210502585	E452P3N5001PC4L
375	1210502586	E452P3N10011C4L
376	1210502589	E452N3N5001PC4M
377	1210502590	E452I2N40011C4M
378	1210502596	E452P3N20012C4H
379	1210502599	E452P2N10K12C4B
380	1210502601	E452A2A30021C4H
381	1210502605	E452P3N15K1PC4H
382	1210502606	E452N3N2001PA1H
383	1210502607	E452D2N50011C4H
384	1210502609	E452N2N30011C45
385	1210502616	E452I2N60011C4M
386	1210502619	E452B3A3001PA1H
387	1210502620	E452B3A3001PA1L
388	1210502621	E452B3A3001PA1M
389	1210502624	E452P3N20011C4L
390	1210502627	E452I2N60011C4H
391	1210502632	E452I2N20011S12
392	1210502633	E452Y3N50011C42
393	1210502634	E452I4N3001PR2M
394	1210502635	E452Y3N20011A15
395	1210502638	E452N3N25041C42
396	1210502639	E452A3A3001RC32
397	1210502640	E452A3A10K1RC32
398	1210502641	E452A3A3001RC44
399	1210502642	E452A3A10K1RC34
400	1210502646	E452I4G30011C4L

Pos.	Molex PN:	Engineering No.:
401	1210502647	E452A2A30011C4H
402	1210502648	E452N3N10011C41
403	1210502650	E452A3A10K1RS0H
404	1210502654	E452P1N50011C45
405	1210502659	E452N3N40011R2H
406	1210502660	E452N2N30011A11
407	1210502662	E452P3N10K1PC4H
408	1210502664	E452N3N3001PC42
409	1210502666	E452B3B50011C4H
410	1210502671	E452I2N15011C3H
411	1210502672	E452I2N40011C3H
412	1210502676	E452I2N20012S12
413	1210502678	E452A3A3001RC42
414	1210502679	E452P3N50011C4M
415	1210502680	E452N3N03011C42
416	1210502681	E452N3N50011C3H
417	1210502682	E452P2N03011C4H
418	1210502683	E452P2N05011C4H
419	1210502686	E452N2N15011C4B
420	1210502687	E452N3N10K1RC4H
421	1210502690	E452N3N0501NC31
422	1210502706	W452N2N5001RC4B
423	1210502712	W452I2N50011S0H
424	1210502715	W452I2N10K11S0H
425	1210502750	W452N3N3001RR2B
426	1210502751	W452N4N2001RS01
427	1210502752	W452N3N2001R000
428	1210502753	W452N3N15K1RC4B
429	1210502755	W452N3N30011C45
430	1210502758	W452I4N20011C7H
431	1210502762	W452I4N20011C4L
432	1210502764	W452I4N20011C4M
433	1210502821	W452I4N50011C7H
434	1210502859	W452N3N10K1RC4B
435	1210502860	W452F4N10K1RS0B
436	1210502861	W452A3A10K1RS0H
437	1210502862	W452N3N3001RC4D
438	1210502863	W452N3N3001RC4B
439	1210502864	W452N3N2001RR05
440	1210502865	W452N3N2001RC4B

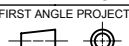
Pos.	Molex PN:	Engineering No.:
441	1210502866	W452N3N2001RC4A
442	1210502867	W452A3A5001RS0H
443	1210502868	W452N3N5001RS0D
444	1210502869	W452N3N5001RC4E
445	1210502870	W452N3N5001RC4D
446	1210502871	W452N3N5001RC4B
447	1210502872	W452N3N3001RC4E
448	1210502874	W452N3N2001RC4H
449	1210502875	W452N3N2001RA1E
450	1210502876	W452P3N5001RC42
451	1210502877	W452N3N2001RC3A
452	1210502878	W452N3N3001RC4C
453	1210502890	W452N3N5001RA1B
454	1210502892	W452N3N2001RC4E
455	1210502893	W452N3N5001RC3B
456	1210502894	W452P3N5001RC4B
457	1210502908	W452N3N5001RC4C
458	1210502909	W452N3N10K1RC4E
459	1210502910	W452N3N10K1RC4C
460	1210502911	W452F4N5001RC4B
461	1210502914	W452N3N3001RR2M
462	1210502915	W452N3N5001RC4A
463	1210502916	E452N3N0501RC4A
464	1210502922	W452I2N50011C7H
465	1210502923	W452I2N20011C7H
466	1210502924	W452I4N3006PC3B
467	1210502925	W452I4N15K6PC3B
468	1210502934	W452N3N5001RC4H
469	1210502942	W452I2N10K6PC3B
470	1210502953	W452I2N5006PC3B
471	1210502955	W452N3N10K1RC4D
472	1210502956	W452N3N30011C44
473	1210502958	W452N3N2001RC3B
474	1210502968	W452P3N10K1RS0H
475	1210502970	W452F4N3001RC4B
476	1210502973	E452I4G30011C42
477	1210502974	W452P3N3001RA1G
478	1210502976	E452N3N10011C4L
479	1210502977	E452N3N30011A11
480	1210502982	E452A3A10012C4H

THIS DRAWING CONTAINS INFORMATION THAT IS PROPRIETARY TO MOLEX ELECTRONIC TECHNOLOGIES, LLC AND SHOULD NOT BE USED WITHOUT WRITTEN PERMISSION									
DIMENSION UNITS		SCALE		CURRENT REV DESC: REVISION CREATED FOR REMOVING PRE-RELEASE STAMP				 E452XXXXXXXXXX DIN FORM A EN 175301-803	
mm		NTS							
GENERAL TOLERANCES (UNLESS SPECIFIED)				EC NO: 714567		2022/07/18		PRODUCT CUSTOMER DRAWING	
				DRWN: SUGEEB		2022/07/19			
				CHK'D: GGA		2022/07/19		DOCUMENT NUMBER	
				APPR: GGA		2022/07/19			
				INITIAL REVISION:				SD-121050-001	
				DRWN: JMARSZALEK		2012/08/27			
				APPR: MDYSZEWSKA		2012/08/20		DOC TYPE DOC PART REVISION	
				ANGULAR TOL				PSD 001 E1	
DRAFT WHERE APPLICABLE MUST REMAIN WITHIN DIMENSIONS				FIRST ANGLE PROJECTION		DRAWING		SHEET NUMBER	
						A3-SIZE		6 OF 41	
				SERIES		MATERIAL NUMBER		CUSTOMER	
				121050		SEE TABLE		GENERAL MARKET	

TABLE 3 - PART LIST

Pos.	Molex PN:	Engineering No.:
481	1210502984	E452A3A10K11C7H
482	1210502985	E452P1N15K11C45
483	1210502987	E452R4N3001PR2E
484	1210502988	E452N3N30022C4H
485	1210502989	E452N3N30022C4M
486	1210502991	E452N2N30011C31
487	1210502994	E452N2N20061C42
488	1210502997	E452N3N50041C42
489	1210503000	E452P2N10011C3B
490	1210503001	E452R4N3001PR2M
491	1210503005	E452P3N12K11C4H
492	1210503007	E452P3N10011R2B
493	1210503008	E452N3N3001GC4M
494	1210503013	E452I2N10011C42
495	1210503014	E452N2N30021A12
496	1210503017	E452I2N30021C3H
497	1210503018	E452N3N30011R22
498	1210503020	W452A3A15K1RS0H
499	1210503022	E452A2A10K11S0L
500	1210503026	E452N2N15011C42
501	1210503030	E452N2N03011C4H
502	1210503032	W452P3N2001RC4E
503	1210503039	E452N3N55011D02
504	1210503041	W452N3N5001RR2D
505	1210503042	E452P3N5001PS0E
506	1210503046	E452N3N2001NC31
507	1210503047	E452B3A50063C4L
508	1210503048	E452B3A50023C4L
509	1210503049	E452A2A70011S0H
510	1210503050	E452N3N30013C4G
511	1210503051	E452N3N50013C4G
512	1210503053	W452N3N2001RC4C
513	1210503056	E452B3A10K1PR2D
514	1210503101	E452N2N30011R2B
515	1210503102	E452N3N3001RC41
516	1210503104	E452A3A15011S0H
517	1210503105	E452A3A30011S0H
518	1210503106	E452A3A75011S0H
519	1210503112	E452I0N30011C4H
520	1210503113	E452N3N5001RC4B

Pos.	Molex PN:	Engineering No.:
521	1210503119	E452I4N80011C7H
522	1210503120	E452I4N3006PC3B
523	1210503123	E452A3A15K1RS0H
524	1210503130	W452N3N5001RR25
525	1210503131	E452I2N5006PC3B
526	1210503132	W452N3N3001RC41
527	1210503135	E452N2N10011C4D
528	1210503138	E452N3N5001RC41
529	1210503139	E452N2N30011R05
530	1210503140	E452B3A30011S0H
531	1210503142	E452P3N50011C44
532	1210503191	E452R4N3001PC4H
533	1210503192	W452A3A10K1RC4M
534	1210503195	E452P3N1501PA1H
535	1210503196	W452N2N30041C4H
536	1210503200	E452P2N20011A12
537	1210503202	E452B3A10012C41
538	1210503203	E452B3A10012C4A
539	1210503204	E452N3N10K12C3H
540	1210503205	E452N3N10K12A1H
541	1210503213	W452N3N50012C4H
542	1210503214	W452P3N10012C4H
543	1210503215	W452N3N30012C4H
544	1210503216	W452P3N30012C4H
545	1210503217	W452P3N20012C4H
546	1210503219	E452I4N30011A1G
547	1210503221	W452I4N30011R2H
548	1210503222	W452I4N30011R2L
549	1210503223	W452I4N30011R2M
550	1210503229	E452N2N25011C42
551	1210503231	E452N3N1001PC4M
552	1210503233	W452N3N30012C4L
553	1210503234	W452P3N50012C4H
554	1210503237	E452P3N5001PC3H
555	1210503238	E452P3N3001PC3H
556	1210503242	E452P3N10K1PC45
557	1210503243	E452P3N5001PC45
558	1210503244	E452P3N15K1PC45
559	1210503248	E452B2A50011C4H
560	1210503256	E452A3A10K12A1H

Pos.	Molex PN:	Engineering No.:
561	1210503257	E452A3A10K12C3H
562	1210503258	W452N3N30012C4H
563	1210503261	E452N3N3001PC4M
564	1210503263	W452B3A3001PA1H
565	N/A	N/A
566	1210503265	E452A2A10011C4H
567	1210503266	W452N2N30011C42
568	1210503267	W452N2N25011C42
569	1210503268	W452A3A50011C7H
570	1210503269	W452N3N10012C4H
571	1210503270	W452N3N50012C4L
572	1210503274	E452N2N10K11C42
573	1210503275	E452I4N30011C41
574	1210503277	E452I4N30011C31
575	N/A	N/A
576	1210503286	E452P3N3001PC4M
577	1210503287	E452P3N3001PC4L
578	1210503326	W452N3N90012C4H
579	1210503330	E452I4N5001PC3H
580	1210503332	E452P3N10K1PA1H
581	1210503333	E452P3N20K1PA1H
582	1210503339	E452P3N1001PC4M
583	1210503340	E452I4G30011C3H
584	1210503341	E452I4G50011C3H
585	1210503344	E452B3A20K11S0H
586	1210503347	E452N3N3001PC4G
587	1210503351	E452N3N3001PA1G
588	1210503357	E452N3N60011C4H
589	1210503359	E452N3N1001PC42
590	1210503360	E452N3N1001PC44
591	1210503361	E452N3N1001PC45
592	1210503362	E452N3N3001PC44
593	1210503363	E452N3N3001PC45
594	1210503364	E452N3N5001PC42
595	1210503365	E452N3N5001PC44
596	1210503366	E452N3N5001PC45
597	1210503403	E452B3A06011A12
598	1210503411	E452P3N1501PC4H
599	1210503415	E452I4N40011C4L
600	1210503416	E452I4G50011C4L

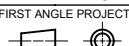
Pos.	Molex PN:	Engineering No.:
601	N/A	N/A
602	1210503424	E452N2N2001RA1H
603	1210503435	E452R4N4001PR2E
604	1210503441	E452B2A1501PS3H
605	1210503442	E452P3N30011C7H
606	1210503443	E452N3N10011D05
607	1210503444	E452P2N75011C4M
608	1210503445	E452P2N16K11C4M
609	1210503446	E452P2N22K11C4M
610	1210503463	E452N3N05011C41
611	1210503464	W452B2A1501PS3H
612	1210503467	E452N3N05011C4A
613	1210503481	E452N3N5001RS0H
614	1210503485	E452I4N1001PC3H
615	1210503490	E452N3N2001PC4B
616	1210503491	E452A3A30011C7H
617	1210503497	E452B2A10K1PC4H
618	1210503498	E452B2A3001PC4H
619	1210503499	E452B2A5001PC4H
620	1210503506	E452B2A10K1PC4L
621	1210503507	E452B2A3001PC4L
622	1210503508	E452B2A5001PC4L
623	1210503509	E452P3N30013C4D
624	1210503510	E452P3N30013R2D
625	1210503512	E452N3N10K1PC4H
626	1210503517	E452N2N1501PS0H
627	1210503520	W452P3N5001RC4D
628	1210503521	W452P3N5001RC4E
629	1210503522	E452P2N5001PS0H
630	1210510097	E452N10261E3552
631	1210510106	E452N30011C4214
632	1210510124	E452P10011C4HBH
633	1210510133	E452P20011C4HBH
634	1210510139	E452P30011C4HBH
635	2210500959	E452A2A10011000
636	2210500960	E452A2A10011A11
637	2210500961	E452A2A10011A12
638	2210500962	E452A2A10011A13
639	2210500963	E452A2A10011A14
640	2210500964	E452A2A10011A15

THIS DRAWING CONTAINS INFORMATION THAT IS PROPRIETARY TO MOLEX ELECTRONIC TECHNOLOGIES, LLC AND SHOULD NOT BE USED WITHOUT WRITTEN PERMISSION									
DIMENSION UNITS		SCALE		CURRENT REV DESC: REVISION CREATED FOR REMOVING PRE-RELEASE STAMP				 E452XXXXXXXXXX DIN FORM A EN 175301-803	
mm		NTS							
GENERAL TOLERANCES (UNLESS SPECIFIED)				EC NO: 714567		2022/07/18		PRODUCT CUSTOMER DRAWING	
				DRWN: SUGEEB		2022/07/19			
				CHK'D: GGA		2022/07/19		DOCUMENT NUMBER	
				APPR: GGA		2022/07/19			
				INITIAL REVISION:				DOC TYPE	
				DRWN: JMARSZALEK		2012/08/27			
				APPR: MDYSZEWSKA		2012/08/20		DOC PART	
ANGULAR TOL ± °				FIRST ANGLE PROJECTION		DRAWING		REVISION	
						A3-SIZE			
DRAFT WHERE APPLICABLE MUST REMAIN WITHIN DIMENSIONS				SERIES		MATERIAL NUMBER		SHEET NUMBER	
				121050		SEE TABLE			
				CUSTOMER		GENERAL MARKET			

TABLE 3 - PART LIST

Pos.	Molex PN:	Engineering No.:
641	2210500965	E452A2A10011R02
642	2210500966	E452A2A10011R03
643	2210500967	E452A2A10011R04
644	2210500968	E452A2A10011R05
645	2210500969	E452A2A10011ROA
646	2210500970	E452A2A10011ROB
647	2210500971	E452A2A10011ROC
648	2210500972	E452A2A10011ROD
649	2210500973	E452A2A10011ROE
650	2210500974	E452A2A10011ROG
651	2210500975	E452A2A10011ROH
652	2210500976	E452A2A10011ROK
653	2210500977	E452A2A10011ROL
654	2210500978	E452A2A10011ROM
655	2210500979	E452A2A10011R21
656	2210500980	E452A2A10011R22
657	2210500981	E452A2A10011R23
658	2210500982	E452A2A10011R24
659	2210500983	E452A2A10011R25
660	2210500984	E452A2A10011R2A
661	2210500985	E452A2A10011R2B
662	2210500986	E452A2A10011R2C
663	2210500987	E452A2A10011R2D
664	2210500988	E452A2A10011R2E
665	2210500989	E452A2A10011R2G
666	2210500990	E452A2A10011R2H
667	2210500991	E452A2A10011R2K
668	2210500992	E452A2A10011R2L
669	2210500993	E452A2A10011R2M
670	2210500994	E452A2A10011S01
671	2210500995	E452A2A10011S02
672	2210500996	E452A2A10011S03
673	2210500997	E452A2A10011S04
674	2210500998	E452A2A10011S05
675	2210500999	E452A2A10011S0A
676	2210501000	E452A2A10011S0B
677	2210501001	E452A2A10011S0C
678	2210501002	E452A2A10011S0D
679	2210501003	E452A2A10011S0E
680	2210501008	E452A2A10011S0G

Pos.	Molex PN:	Engineering No.:
681	N/A	N/A
682	N/A	N/A
683	N/A	N/A
684	2210501023	E452A2A10011R05
685	N/A	N/A
686	N/A	N/A
687	N/A	N/A
688	N/A	N/A
689	N/A	N/A
690	N/A	N/A
691	N/A	N/A
692	N/A	N/A
693	N/A	N/A
694	N/A	N/A
695	2210501034	E452A2A10011R21
696	2210501035	E452A2A10011R22
697	2210501036	E452A2A10011R23
698	2210501037	E452A2A10011R24
699	2210501038	E452A2A10011R25
700	2210501039	E452A2A10011R2A
701	2210501040	E452A2A10011R2B
702	2210501041	E452A2A10011R2C
703	2210501042	E452A2A10011R2D
704	2210501043	E452A2A10011R2E
705	2210501044	E452A2A10011R2G
706	2210501045	E452A2A10011R2H
707	2210501046	E452A2A10011R2K
708	2210501047	E452A2A10011R2L
709	2210501048	E452A2A10011R2M
710	2210501049	E452A2A10011S01
711	2210501050	E452A2A10011S02
712	2210501051	E452A2A10011S03
713	2210501052	E452A2A10011S04
714	2210501053	E452A2A10011S05
715	2210501054	E452A2A10011S0A
716	2210501055	E452A2A10011S0B
717	2210501056	E452A2A10011S0C
718	2210501057	E452A2A10011S0D
719	2210501058	E452A2A10011S0E
720	2210501059	E452A2A10011S0G

Pos.	Molex PN:	Engineering No.:
721	2210501060	E452A2A10011S0K
722	2210501061	E452A2A10011S0L
723	2210501062	E452A2A10011S0M
724	2210501063	E452A2A10K11000
725	2210501064	E452A2A10K11A11
726	2210501065	E452A2A10K11A12
727	2210501066	E452A2A10K11A13
728	2210501067	E452A2A10K11A14
729	2210501068	E452A2A10K11A15
730	2210501069	E452A2A10K11A1A
731	2210501070	E452A2A10K11A1B
732	2210501071	E452A2A10K11A1C
733	2210501072	E452A2A10K11A1D
734	2210501073	E452A2A10K11A1E
735	2210501074	E452A2A10K11A1G
736	2210501075	E452A2A10K11A1H
737	2210501076	E452A2A10K11A1K
738	2210501077	E452A2A10K11A1L
739	2210501078	E452A2A10K11A1M
740	2210501079	E452A2A10K11C31
741	2210501080	E452A2A10K11C32
742	2210501081	E452A2A10K11C33
743	2210501082	E452A2A10K11C34
744	2210501083	E452A2A10K11C35
745	2210501084	E452A2A10K11C3A
746	2210501085	E452A2A10K11C3B
747	2210501086	E452A2A10K11C3C
748	2210501087	E452A2A10K11C3D
749	2210501088	E452A2A10K11C3E
750	2210501089	E452A2A10K11C3G
751	2210501090	E452A2A10K11C3H
752	2210501091	E452A2A10K11C3K
753	2210501092	E452A2A10K11C3L
754	2210501093	E452A2A10K11C3M
755	2210501094	E452A2A10K11C41
756	2210501095	E452A2A10K11C42
757	2210501096	E452A2A10K11C43
758	2210501097	E452A2A10K11C44
759	2210501098	E452A2A10K11C45
760	2210501099	E452A2A10K11C4A

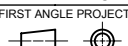
Pos.	Molex PN:	Engineering No.:
761	2210501100	E452A2A10K11C4B
762	2210501101	E452A2A10K11C4C
763	2210501102	E452A2A10K11C4D
764	2210501103	E452A2A10K11C4E
765	2210501104	E452A2A10K11C4G
766	2210501105	E452A2A10K11C4H
767	2210501106	E452A2A10K11C4K
768	2210501107	E452A2A10K11C4L
769	2210501108	E452A2A10K11C4M
770	2210501113	E452A2A10K11E05
771	N/A	N/A
772	N/A	N/A
773	N/A	N/A
774	N/A	N/A
775	2210501128	E452A2A10K11R05
776	N/A	N/A
777	N/A	N/A
778	N/A	N/A
779	N/A	N/A
780	N/A	N/A
781	N/A	N/A
782	N/A	N/A
783	N/A	N/A
784	N/A	N/A
785	N/A	N/A
786	2210501139	E452A2A10K11R21
787	2210501140	E452A2A10K11R22
788	2210501141	E452A2A10K11R23
789	2210501142	E452A2A10K11R24
790	2210501143	E452A2A10K11R25
791	2210501144	E452A2A10K11R2A
792	2210501145	E452A2A10K11R2B
793	2210501146	E452A2A10K11R2C
794	2210501147	E452A2A10K11R2D
795	2210501148	E452A2A10K11R2E
796	2210501149	E452A2A10K11R2G
797	2210501150	E452A2A10K11R2H
798	2210501151	E452A2A10K11R2K
799	2210501152	E452A2A10K11R2L
800	2210501153	E452A2A10K11R2M

Pos.	Molex PN:	Engineering No.:
801	2210501154	E452A2A10K11S01
802	2210501155	E452A2A10K11S02
803	2210501156	E452A2A10K11S03
804	2210501157	E452A2A10K11S04
805	2210501158	E452A2A10K11S05
806	2210501159	E452A2A10K11S0A
807	2210501160	E452A2A10K11S0B
808	2210501161	E452A2A10K11S0C
809	2210501162	E452A2A10K11S0D
810	2210501163	E452A2A10K11S0E
811	2210501164	E452A2A10K11S0G
812	2210501165	E452A2A10K11S0K
813	2210501166	E452A2A10K11S0M
814	2210501167	E452A2A15011000
815	2210501168	E452A2A15011A11
816	2210501169	E452A2A15011A12
817	2210501170	E452A2A15011A13
818	2210501171	E452A2A15011A14
819	2210501172	E452A2A15011A15
820	2210501173	E452A2A15011A1A
821	2210501174	E452A2A15011A1B
822	2210501175	E452A2A15011A1C
823	2210501176	E452A2A15011A1D
824	2210501177	E452A2A15011A1E
825	2210501178	E452A2A15011A1G
826	2210501179	E452A2A15011A1H
827	2210501180	E452A2A15011A1K
828	2210501181	E452A2A15011A1L
829	2210501182	E452A2A15011A1M
830	2210501183	E452A2A15011C31
831	2210501184	E452A2A15011C32
832	2210501185	E452A2A15011C33
833	2210501186	E452A2A15011C34
834	2210501187	E452A2A15011C35
835	2210501188	E452A2A15011C3A
836	2210501189	E452A2A15011C3B
837	2210501190	E452A2A15011C3C
838	2210501191	E452A2A15011C3D
839	2210501192	E452A2A15011C3E
840	2210501193	E452A2A15011C3G

THIS DRAWING CONTAINS INFORMATION THAT IS PROPRIETARY TO MOLEX ELECTRONIC TECHNOLOGIES, LLC AND SHOULD NOT BE USED WITHOUT WRITTEN PERMISSION									
DIMENSION UNITS		SCALE		CURRENT REV DESC: REVISION CREATED FOR REMOVING PRE-RELEASE STAMP				 E452XXXXXXXXXX DIN FORM A EN 175301-803	
mm		NTS							
GENERAL TOLERANCES (UNLESS SPECIFIED)				EC NO: 714567		2022/07/18		PRODUCT CUSTOMER DRAWING DOCUMENT NUMBER: SD-121050-001 DOC TYPE: PSD DOC PART: 001 REVISION: E1	
				DRWN: SUGEEB		2022/07/19			
				CHK'D: GGA		2022/07/19			
				APPR: GGA					
				INITIAL REVISION:					
				DRWN: JMARSZALEK		2012/08/27			
				APPR: MDYSZEWSKA		2012/08/20			
DRAFT WHERE APPLICABLE MUST REMAIN WITHIN DIMENSIONS				FIRST ANGLE PROJECTION		DRAWING		SHEET NUMBER	
						A3-SIZE		8 OF 41	

TABLE 3 - PART LIST

Pos.	Molex PN:	Engineering No.:
1001	2210501382	E452A2A30011A1B
1002	2210501383	E452A2A30011A1C
1003	2210501384	E452A2A30011A1D
1004	2210501385	E452A2A30011A1E
1005	2210501386	E452A2A30011A1G
1006	2210501387	E452A2A30011A1H
1007	2210501388	E452A2A30011A1K
1008	2210501389	E452A2A30011A1L
1009	2210501390	E452A2A30011A1M
1010	2210501391	E452A2A30011C31
1011	2210501392	E452A2A30011C33
1012	2210501393	E452A2A30011C34
1013	2210501394	E452A2A30011C35
1014	2210501395	E452A2A30011C3A
1015	2210501396	E452A2A30011C3B
1016	2210501397	E452A2A30011C3C
1017	2210501398	E452A2A30011C3D
1018	2210501399	E452A2A30011C3E
1019	2210501400	E452A2A30011C3G
1020	2210501401	E452A2A30011C3H
1021	2210501402	E452A2A30011C3K
1022	2210501403	E452A2A30011C3L
1023	2210501404	E452A2A30011C3M
1024	2210501405	E452A2A30011C41
1025	2210501406	E452A2A30011C42
1026	2210501407	E452A2A30011C43
1027	2210501408	E452A2A30011C44
1028	2210501409	E452A2A30011C45
1029	2210501410	E452A2A30011C4A
1030	2210501411	E452A2A30011C4B
1031	2210501412	E452A2A30011C4C
1032	2210501413	E452A2A30011C4D
1033	2210501414	E452A2A30011C4E
1034	2210501415	E452A2A30011C4G
1035	2210501416	E452A2A30011C4K
1036	2210501417	E452A2A30011C4L
1037	2210501418	E452A2A30011C4M
1038	2210501423	E452A2A30011E05
1039	N/A	N/A
1040	N/A	N/A

Pos.	Molex PN:	Engineering No.:
1041	N/A	N/A
1042	N/A	N/A
1043	2210501438	E452A2A30011R05
1044	N/A	N/A
1045	N/A	N/A
1046	N/A	N/A
1047	N/A	N/A
1048	N/A	N/A
1049	N/A	N/A
1050	N/A	N/A
1051	N/A	N/A
1052	N/A	N/A
1053	N/A	N/A
1054	2210501449	E452A2A30011R21
1055	2210501450	E452A2A30011R22
1056	2210501451	E452A2A30011R23
1057	2210501452	E452A2A30011R24
1058	2210501453	E452A2A30011R25
1059	2210501454	E452A2A30011R2A
1060	2210501455	E452A2A30011R2B
1061	2210501456	E452A2A30011R2C
1062	2210501457	E452A2A30011R2D
1063	2210501458	E452A2A30011R2E
1064	2210501459	E452A2A30011R2G
1065	2210501460	E452A2A30011R2H
1066	2210501461	E452A2A30011R2K
1067	2210501462	E452A2A30011R2L
1068	2210501463	E452A2A30011R2M
1069	2210501464	E452A2A30011S01
1070	2210501465	E452A2A30011S02
1071	2210501466	E452A2A30011S03
1072	2210501467	E452A2A30011S04
1073	2210501468	E452A2A30011S05
1074	2210501469	E452A2A30011S0A
1075	2210501470	E452A2A30011S0B
1076	2210501471	E452A2A30011S0C
1077	2210501472	E452A2A30011S0D
1078	2210501473	E452A2A30011S0E
1079	2210501474	E452A2A30011S0G
1080	2210501475	E452A2A30011S0K

Pos.	Molex PN:	Engineering No.:
1081	2210501476	E452A2A30011S0L
1082	2210501477	E452A2A30011S0M
1083	2210501478	E452A2A50011000
1084	2210501479	E452A2A50011A11
1085	2210501480	E452A2A50011A12
1086	2210501481	E452A2A50011A13
1087	2210501482	E452A2A50011A14
1088	2210501483	E452A2A50011A15
1089	2210501484	E452A2A50011A1A
1090	2210501485	E452A2A50011A1B
1091	2210501486	E452A2A50011A1C
1092	2210501487	E452A2A50011A1D
1093	2210501488	E452A2A50011A1E
1094	2210501489	E452A2A50011A1G
1095	2210501490	E452A2A50011A1H
1096	2210501491	E452A2A50011A1K
1097	2210501492	E452A2A50011A1L
1098	2210501493	E452A2A50011A1M
1099	2210501494	E452A2A50011C31
1100	2210501495	E452A2A50011C32
1101	2210501496	E452A2A50011C33
1102	2210501497	E452A2A50011C34
1103	2210501498	E452A2A50011C35
1104	2210501499	E452A2A50011C3A
1105	2210501500	E452A2A50011C3B
1106	2210501501	E452A2A50011C3C
1107	2210501502	E452A2A50011C3D
1108	2210501503	E452A2A50011C3E
1109	2210501504	E452A2A50011C3G
1110	2210501505	E452A2A50011C3H
1111	2210501506	E452A2A50011C3K
1112	2210501507	E452A2A50011C3L
1113	2210501508	E452A2A50011C3M
1114	2210501509	E452A2A50011C41
1115	2210501510	E452A2A50011C42
1116	2210501511	E452A2A50011C43
1117	2210501512	E452A2A50011C44
1118	2210501513	E452A2A50011C45
1119	2210501514	E452A2A50011C4A
1120	2210501515	E452A2A50011C4B

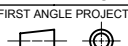
Pos.	Molex PN:	Engineering No.:
1121	2210501516	E452A2A50011C4C
1122	2210501517	E452A2A50011C4D
1123	2210501518	E452A2A50011C4E
1124	2210501519	E452A2A50011C4G
1125	2210501520	E452A2A50011C4H
1126	2210501521	E452A2A50011C4K
1127	2210501522	E452A2A50011C4L
1128	2210501523	E452A2A50011C4M
1129	2210501528	E452A2A50011E05
1130	N/A	N/A
1131	N/A	N/A
1132	N/A	N/A
1133	N/A	N/A
1134	2210501543	E452A2A50011R05
1135	N/A	N/A
1136	N/A	N/A
1137	N/A	N/A
1138	N/A	N/A
1139	N/A	N/A
1140	N/A	N/A
1141	N/A	N/A
1142	N/A	N/A
1143	N/A	N/A
1144	N/A	N/A
1145	2210501554	E452A2A50011R21
1146	2210501555	E452A2A50011R22
1147	2210501556	E452A2A50011R23
1148	2210501557	E452A2A50011R24
1149	2210501558	E452A2A50011R25
1150	2210501559	E452A2A50011R2A
1151	2210501560	E452A2A50011R2B
1152	2210501561	E452A2A50011R2C
1153	2210501562	E452A2A50011R2D
1154	2210501563	E452A2A50011R2E
1155	2210501564	E452A2A50011R2G
1156	2210501565	E452A2A50011R2H
1157	2210501566	E452A2A50011R2K
1158	2210501567	E452A2A50011R2L
1159	2210501568	E452A2A50011R2M
1160	2210501569	E452A2A50011S01

THIS DRAWING CONTAINS INFORMATION THAT IS PROPRIETARY TO MOLEX ELECTRONIC TECHNOLOGIES, LLC AND SHOULD NOT BE USED WITHOUT WRITTEN PERMISSION									
DIMENSION UNITS		SCALE		CURRENT REV DESC: REVISION CREATED FOR REMOVING PRE-RELEASE STAMP				 E452XXXXXXXXXX DIN FORM A EN 175301-803	
mm		NTS							
GENERAL TOLERANCES (UNLESS SPECIFIED)				EC NO: 714567		2022/07/18		PRODUCT CUSTOMER DRAWING	
				DRWN: SUGEEB		2022/07/19			
				CHK'D: GGA		2022/07/19		DOCUMENT NUMBER	
				APPR: GGA		2022/07/19			
				INITIAL REVISION:				SD-121050-001	
				DRWN: JMARSZALEK		2012/08/27			
				APPR: MDYSZEWSKA		2012/08/20		DOC TYPE	
				ANGULAR TOL				DOC PART	
				DRAFT WHERE APPLICABLE MUST REMAIN WITHIN DIMENSIONS		FIRST ANGLE PROJECTION		REVISION	
						DRAWING		PSD	
						SERIES		001	
						MATERIAL NUMBER		E1	
						CUSTOMER			
						SHEET NUMBER			
						SEE TABLE		10 OF 41	
						GENERAL MARKET			

TABLE 3 - PART LIST

Pos.	Molex PN:	Engineering No.:
1161	2210501570	E452A2A50011S02
1162	2210501571	E452A2A50011S03
1163	2210501572	E452A2A50011S04
1164	2210501573	E452A2A50011S05
1165	2210501574	E452A2A50011S0A
1166	2210501575	E452A2A50011S0B
1167	2210501576	E452A2A50011S0C
1168	2210501577	E452A2A50011S0D
1169	2210501578	E452A2A50011S0E
1170	2210501579	E452A2A50011S0G
1171	2210501580	E452A2A50011S0K
1172	2210501581	E452A2A50011S0L
1173	2210501582	E452A2A50011S0M
1174	2210501583	E452A3A10011000
1175	2210501584	E452A3A10011A11
1176	2210501585	E452A3A10011A12
1177	2210501586	E452A3A10011A13
1178	2210501587	E452A3A10011A14
1179	2210501588	E452A3A10011A15
1180	2210501589	E452A3A10011A1A
1181	2210501590	E452A3A10011A1B
1182	2210501591	E452A3A10011A1C
1183	2210501592	E452A3A10011A1D
1184	2210501593	E452A3A10011A1E
1185	2210501594	E452A3A10011A1G
1186	2210501595	E452A3A10011A1H
1187	2210501596	E452A3A10011A1K
1188	2210501597	E452A3A10011A1L
1189	2210501598	E452A3A10011A1M
1190	2210501599	E452A3A10011C31
1191	2210501600	E452A3A10011C32
1192	2210501601	E452A3A10011C33
1193	2210501602	E452A3A10011C34
1194	2210501603	E452A3A10011C35
1195	2210501604	E452A3A10011C3A
1196	2210501605	E452A3A10011C3B
1197	2210501606	E452A3A10011C3C
1198	2210501607	E452A3A10011C3D
1199	2210501608	E452A3A10011C3E
1200	2210501609	E452A3A10011C3G

Pos.	Molex PN:	Engineering No.:
1201	2210501610	E452A3A10011C3H
1202	2210501611	E452A3A10011C3K
1203	2210501612	E452A3A10011C3L
1204	2210501613	E452A3A10011C3M
1205	2210501614	E452A3A10011C41
1206	2210501615	E452A3A10011C43
1207	2210501616	E452A3A10011C44
1208	2210501617	E452A3A10011C45
1209	2210501618	E452A3A10011C4A
1210	2210501619	E452A3A10011C4B
1211	2210501620	E452A3A10011C4C
1212	2210501621	E452A3A10011C4D
1213	2210501622	E452A3A10011C4E
1214	2210501623	E452A3A10011C4G
1215	2210501624	E452A3A10011C4H
1216	2210501625	E452A3A10011C4K
1217	2210501626	E452A3A10011C4L
1218	2210501627	E452A3A10011C4M
1219	2210501632	E452A3A10011E05
1220	N/A	N/A
1221	N/A	N/A
1222	N/A	N/A
1223	N/A	N/A
1224	2210501647	E452A3A10011R05
1225	N/A	N/A
1226	N/A	N/A
1227	N/A	N/A
1228	N/A	N/A
1229	N/A	N/A
1230	N/A	N/A
1231	N/A	N/A
1232	N/A	N/A
1233	N/A	N/A
1234	N/A	N/A
1235	2210501658	E452A3A10011R21
1236	2210501659	E452A3A10011R22
1237	2210501660	E452A3A10011R23
1238	2210501661	E452A3A10011R24
1239	2210501662	E452A3A10011R25
1240	2210501663	E452A3A10011R2A

Pos.	Molex PN:	Engineering No.:
1241	2210501664	E452A3A10011R2B
1242	2210501665	E452A3A10011R2C
1243	2210501666	E452A3A10011R2D
1244	2210501667	E452A3A10011R2E
1245	2210501668	E452A3A10011R2G
1246	2210501669	E452A3A10011R2H
1247	2210501670	E452A3A10011R2K
1248	2210501671	E452A3A10011R2L
1249	2210501672	E452A3A10011R2M
1250	2210501673	E452A3A10011S01
1251	2210501674	E452A3A10011S02
1252	2210501675	E452A3A10011S03
1253	2210501676	E452A3A10011S04
1254	2210501677	E452A3A10011S05
1255	2210501678	E452A3A10011S0A
1256	2210501679	E452A3A10011S0B
1257	2210501680	E452A3A10011S0C
1258	2210501681	E452A3A10011S0D
1259	2210501682	E452A3A10011S0E
1260	2210501683	E452A3A10011S0G
1261	2210501684	E452A3A10011S0H
1262	2210501685	E452A3A10011S0K
1263	2210501686	E452A3A10011S0L
1264	2210501687	E452A3A10011S0M
1265	2210501688	E452A3A10K11000
1266	2210501689	E452A3A10K11A11
1267	2210501690	E452A3A10K11A12
1268	2210501691	E452A3A10K11A13
1269	2210501692	E452A3A10K11A14
1270	2210501693	E452A3A10K11A15
1271	2210501694	E452A3A10K11A1A
1272	2210501695	E452A3A10K11A1B
1273	2210501696	E452A3A10K11A1C
1274	2210501697	E452A3A10K11A1D
1275	2210501698	E452A3A10K11A1E
1276	2210501699	E452A3A10K11A1G
1277	2210501700	E452A3A10K11A1H
1278	2210501701	E452A3A10K11A1K
1279	2210501702	E452A3A10K11A1L
1280	2210501703	E452A3A10K11A1M

Pos.	Molex PN:	Engineering No.:
1281	2210501704	E452A3A10K11C31
1282	2210501705	E452A3A10K11C32
1283	2210501706	E452A3A10K11C33
1284	2210501707	E452A3A10K11C34
1285	2210501708	E452A3A10K11C35
1286	2210501709	E452A3A10K11C3A
1287	2210501710	E452A3A10K11C3B
1288	2210501711	E452A3A10K11C3C
1289	2210501712	E452A3A10K11C3D
1290	2210501713	E452A3A10K11C3E
1291	2210501714	E452A3A10K11C3G
1292	2210501715	E452A3A10K11C3H
1293	2210501716	E452A3A10K11C3K
1294	2210501717	E452A3A10K11C3L
1295	2210501718	E452A3A10K11C3M
1296	2210501719	E452A3A10K11C41
1297	2210501720	E452A3A10K11C42
1298	2210501721	E452A3A10K11C43
1299	2210501722	E452A3A10K11C44
1300	2210501723	E452A3A10K11C45
1301	2210501724	E452A3A10K11C4A
1302	2210501725	E452A3A10K11C4B
1303	2210501726	E452A3A10K11C4C
1304	2210501727	E452A3A10K11C4D
1305	2210501728	E452A3A10K11C4E
1306	2210501729	E452A3A10K11C4G
1307	2210501730	E452A3A10K11C4H
1308	2210501731	E452A3A10K11C4K
1309	2210501732	E452A3A10K11C4L
1310	2210501733	E452A3A10K11C4M
1311	2210501738	E452A3A10K11E05
1312	N/A	N/A
1313	N/A	N/A
1314	N/A	N/A
1315	N/A	N/A
1316	2210501753	E452A3A10K11R05
1317	N/A	N/A
1318	N/A	N/A
1319	N/A	N/A
1320	N/A	N/A

THIS DRAWING CONTAINS INFORMATION THAT IS PROPRIETARY TO MOLEX ELECTRONIC TECHNOLOGIES, LLC AND SHOULD NOT BE USED WITHOUT WRITTEN PERMISSION									
DIMENSION UNITS		SCALE		CURRENT REV DESC: REVISION CREATED FOR REMOVING PRE-RELEASE STAMP				 E452XXXXXXXXXX DIN FORM A EN 175301-803	
mm		NTS							
GENERAL TOLERANCES (UNLESS SPECIFIED)				EC NO: 714567		2022/07/18		PRODUCT CUSTOMER DRAWING	
				DRWN: SUGEEB		2022/07/19			
				CHK'D: GGA		2022/07/19		DOCUMENT NUMBER SD-121050-001	
				APPR: GGA		2022/07/19			
				INITIAL REVISION:		2012/08/27		DOC TYPE PSD	
				DRWN: JMARSZALEK		2012/08/27			
				APPR: MDYSZEWSKA		2012/08/20		DOC PART 001	
DRAFT WHERE APPLICABLE MUST REMAIN WITHIN DIMENSIONS				FIRST ANGLE PROJECTION		DRAWING		REVISION	
						A3-SIZE		SHEET NUMBER 11 OF 41	
						SERIES		MATERIAL NUMBER SEE TABLE	
						121050		CUSTOMER GENERAL MARKET	

TABLE 3 - PART LIST

Pos.	Molex PN:	Engineering No.:
1321	N/A	N/A
1322	N/A	N/A
1323	N/A	N/A
1324	N/A	N/A
1325	N/A	N/A
1326	N/A	N/A
1327	2210501764	E452A3A10K11R21
1328	2210501765	E452A3A10K11R22
1329	2210501766	E452A3A10K11R23
1330	2210501767	E452A3A10K11R24
1331	2210501768	E452A3A10K11R25
1332	2210501769	E452A3A10K11R2A
1333	2210501770	E452A3A10K11R2B
1334	2210501771	E452A3A10K11R2C
1335	2210501772	E452A3A10K11R2D
1336	2210501773	E452A3A10K11R2E
1337	2210501774	E452A3A10K11R2G
1338	2210501775	E452A3A10K11R2H
1339	2210501776	E452A3A10K11R2K
1340	2210501777	E452A3A10K11R2L
1341	2210501778	E452A3A10K11R2M
1342	2210501779	E452A3A10K11S01
1343	2210501780	E452A3A10K11S02
1344	2210501781	E452A3A10K11S03
1345	2210501782	E452A3A10K11S04
1346	2210501783	E452A3A10K11S05
1347	2210501784	E452A3A10K11S0A
1348	2210501785	E452A3A10K11S0B
1349	2210501786	E452A3A10K11S0C
1350	2210501787	E452A3A10K11S0D
1351	2210501788	E452A3A10K11S0E
1352	2210501789	E452A3A10K11S0G
1353	2210501790	E452A3A10K11S0K
1354	2210501791	E452A3A10K11S0L
1355	2210501792	E452A3A10K11S0M
1356	2210501793	E452A3A15011000
1357	2210501794	E452A3A15011A11
1358	2210501795	E452A3A15011A12
1359	2210501796	E452A3A15011A13
1360	2210501797	E452A3A15011A14

Pos.	Molex PN:	Engineering No.:
1361	2210501798	E452A3A15011A15
1362	2210501799	E452A3A15011A1A
1363	2210501800	E452A3A15011A1B
1364	2210501801	E452A3A15011A1C
1365	2210501802	E452A3A15011A1D
1366	2210501803	E452A3A15011A1E
1367	2210501804	E452A3A15011A1G
1368	2210501805	E452A3A15011A1H
1369	2210501806	E452A3A15011A1K
1370	2210501807	E452A3A15011A1L
1371	2210501808	E452A3A15011A1M
1372	2210501809	E452A3A15011C31
1373	2210501810	E452A3A15011C32
1374	2210501811	E452A3A15011C33
1375	2210501812	E452A3A15011C34
1376	2210501813	E452A3A15011C35
1377	2210501814	E452A3A15011C3A
1378	2210501815	E452A3A15011C3B
1379	2210501816	E452A3A15011C3C
1380	2210501817	E452A3A15011C3D
1381	2210501818	E452A3A15011C3E
1382	2210501819	E452A3A15011C3G
1383	2210501820	E452A3A15011C3H
1384	2210501821	E452A3A15011C3K
1385	2210501822	E452A3A15011C3L
1386	2210501823	E452A3A15011C3M
1387	2210501824	E452A3A15011C41
1388	2210501825	E452A3A15011C42
1389	2210501826	E452A3A15011C43
1390	2210501827	E452A3A15011C44
1391	2210501828	E452A3A15011C45
1392	2210501829	E452A3A15011C4A
1393	2210501830	E452A3A15011C4B
1394	2210501831	E452A3A15011C4C
1395	2210501832	E452A3A15011C4D
1396	2210501833	E452A3A15011C4E
1397	2210501834	E452A3A15011C4G
1398	2210501835	E452A3A15011C4H
1399	2210501836	E452A3A15011C4K
1400	2210501837	E452A3A15011C4L

Pos.	Molex PN:	Engineering No.:
1401	2210501838	E452A3A15011C4M
1402	2210501843	E452A3A15011E05
1403	N/A	N/A
1404	N/A	N/A
1405	N/A	N/A
1406	N/A	N/A
1407	2210501858	E452A3A15011R05
1408	N/A	N/A
1409	N/A	N/A
1410	N/A	N/A
1411	N/A	N/A
1412	N/A	N/A
1413	N/A	N/A
1414	N/A	N/A
1415	N/A	N/A
1416	N/A	N/A
1417	N/A	N/A
1418	2210501869	E452A3A15011R21
1419	2210501870	E452A3A15011R22
1420	2210501871	E452A3A15011R23
1421	2210501872	E452A3A15011R24
1422	2210501873	E452A3A15011R25
1423	2210501874	E452A3A15011R2A
1424	2210501875	E452A3A15011R2B
1425	2210501876	E452A3A15011R2C
1426	2210501877	E452A3A15011R2D
1427	2210501878	E452A3A15011R2E
1428	2210501879	E452A3A15011R2G
1429	2210501880	E452A3A15011R2H
1430	2210501881	E452A3A15011R2K
1431	2210501882	E452A3A15011R2L
1432	2210501883	E452A3A15011R2M
1433	2210501884	E452A3A15011S01
1434	2210501885	E452A3A15011S02
1435	2210501886	E452A3A15011S03
1436	2210501887	E452A3A15011S04
1437	2210501888	E452A3A15011S05
1438	2210501889	E452A3A15011S0A
1439	2210501890	E452A3A15011S0B
1440	2210501891	E452A3A15011S0C

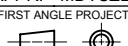
Pos.	Molex PN:	Engineering No.:
1441	2210501892	E452A3A15011S0D
1442	2210501893	E452A3A15011S0E
1443	2210501894	E452A3A15011S0G
1444	2210501895	E452A3A15011S0K
1445	2210501896	E452A3A15011S0L
1446	2210501897	E452A3A15011S0M
1447	2210501898	E452A3A20011000
1448	2210501899	E452A3A20011A11
1449	2210501900	E452A3A20011A12
1450	2210501901	E452A3A20011A13
1451	2210501902	E452A3A20011A14
1452	2210501903	E452A3A20011A15
1453	2210501904	E452A3A20011A1A
1454	2210501905	E452A3A20011A1B
1455	2210501906	E452A3A20011A1C
1456	2210501907	E452A3A20011A1D
1457	2210501908	E452A3A20011A1E
1458	2210501909	E452A3A20011A1G
1459	2210501910	E452A3A20011A1H
1460	2210501911	E452A3A20011A1K
1461	2210501912	E452A3A20011A1L
1462	2210501913	E452A3A20011C31
1463	2210501914	E452A3A20011C32
1464	2210501915	E452A3A20011C33
1465	2210501916	E452A3A20011C34
1466	2210501917	E452A3A20011C35
1467	2210501918	E452A3A20011C3A
1468	2210501919	E452A3A20011C3B
1469	2210501920	E452A3A20011C3C
1470	2210501921	E452A3A20011C3D
1471	2210501922	E452A3A20011C3E
1472	2210501923	E452A3A20011C3G
1473	2210501924	E452A3A20011C3H
1474	2210501925	E452A3A20011C3K
1475	2210501926	E452A3A20011C3L
1476	2210501927	E452A3A20011C3M
1477	2210501928	E452A3A20011C41
1478	2210501929	E452A3A20011C43
1479	2210501930	E452A3A20011C4A
1480	2210501931	E452A3A20011C4B

THIS DRAWING CONTAINS INFORMATION THAT IS PROPRIETARY TO MOLEX ELECTRONIC TECHNOLOGIES, LLC AND SHOULD NOT BE USED WITHOUT WRITTEN PERMISSION		SCALE NTS		CURRENT REV DESC: REVISION CREATED FOR REMOVING PRE-RELEASE STAMP		molex	
DIMENSION UNITS mm		GENERAL TOLERANCES (UNLESS SPECIFIED)		EC NO: 714567 DRWN: SUGEEB CHK'D: GGA APPR: GGA			
4 PLACES ±		MM INCH		2022/07/18		PRODUCT CUSTOMER DRAWING	
3 PLACES ±				2022/07/19		DOCUMENT NUMBER	
2 PLACES ±				2022/07/19		SD-121050-001	
1 PLACE ±				INITIAL REVISION:		DOC TYPE DOC PART REVISION	
0 PLACES ±				DRWN: JMARSZALEK APPR: MDYSZEWSKA		PSD 001 E1	
ANGULAR TOL ± °		FIRST ANGLE PROJECTION		2012/08/27 2012/08/20		SHEET NUMBER	
DRAFT WHERE APPLICABLE MUST REMAIN WITHIN DIMENSIONS		DRAWING		SERIES		MATERIAL NUMBER CUSTOMER	
		A3-SIZE		121050		SEE TABLE GENERAL MARKET	
						12 OF 41	

TABLE 3 - PART LIST

Pos.	Molex PN:	Engineering No.:
1481	2210501932	E452A3A20011C4C
1482	2210501933	E452A3A20011C4D
1483	2210501934	E452A3A20011C4E
1484	2210501935	E452A3A20011C4G
1485	2210501936	E452A3A20011C4H
1486	2210501937	E452A3A20011C4K
1487	2210501938	E452A3A20011C4L
1488	2210501939	E452A3A20011C4M
1489	2210501944	E452A3A20011E05
1490	N/A	N/A
1491	N/A	N/A
1492	N/A	N/A
1493	N/A	N/A
1494	2210501959	E452A3A20011R05
1495	N/A	N/A
1496	N/A	N/A
1497	N/A	N/A
1498	N/A	N/A
1499	N/A	N/A
1500	N/A	N/A
1501	N/A	N/A
1502	N/A	N/A
1503	N/A	N/A
1504	N/A	N/A
1505	2210501970	E452A3A20011R21
1506	2210501971	E452A3A20011R22
1507	2210501972	E452A3A20011R23
1508	2210501973	E452A3A20011R24
1509	2210501974	E452A3A20011R25
1510	2210501975	E452A3A20011R2A
1511	2210501976	E452A3A20011R2B
1512	2210501977	E452A3A20011R2C
1513	2210501978	E452A3A20011R2D
1514	2210501979	E452A3A20011R2E
1515	2210501980	E452A3A20011R2G
1516	2210501981	E452A3A20011R2H
1517	2210501982	E452A3A20011R2K
1518	2210501983	E452A3A20011R2L
1519	2210501984	E452A3A20011R2M
1520	2210501985	E452A3A20011S01

Pos.	Molex PN:	Engineering No.:
1521	2210501986	E452A3A20011S02
1522	2210501987	E452A3A20011S03
1523	2210501988	E452A3A20011S04
1524	2210501989	E452A3A20011S05
1525	2210501990	E452A3A20011S0A
1526	2210501991	E452A3A20011S0B
1527	2210501992	E452A3A20011S0C
1528	2210501993	E452A3A20011S0D
1529	2210501994	E452A3A20011S0E
1530	2210501995	E452A3A20011S0G
1531	2210501996	E452A3A20011S0H
1532	2210501997	E452A3A20011S0K
1533	2210501998	E452A3A20011S0L
1534	2210501999	E452A3A20011S0M
1535	2210502000	E452A3A30011000
1536	2210502001	E452A3A30011A11
1537	2210502002	E452A3A30011A12
1538	2210502003	E452A3A30011A13
1539	2210502004	E452A3A30011A14
1540	2210502005	E452A3A30011A15
1541	2210502006	E452A3A30011A1A
1542	2210502007	E452A3A30011A1B
1543	2210502008	E452A3A30011A1C
1544	2210502009	E452A3A30011A1D
1545	2210502010	E452A3A30011A1E
1546	2210502011	E452A3A30011A1G
1547	2210502012	E452A3A30011A1H
1548	2210502013	E452A3A30011A1K
1549	2210502014	E452A3A30011A1L
1550	2210502015	E452A3A30011A1M
1551	2210502016	E452A3A30011C31
1552	2210502017	E452A3A30011C32
1553	2210502018	E452A3A30011C33
1554	2210502019	E452A3A30011C34
1555	2210502020	E452A3A30011C35
1556	2210502021	E452A3A30011C3A
1557	2210502022	E452A3A30011C3B
1558	2210502023	E452A3A30011C3C
1559	2210502024	E452A3A30011C3D
1560	2210502025	E452A3A30011C3E

Pos.	Molex PN:	Engineering No.:
1561	2210502026	E452A3A30011C3G
1562	2210502027	E452A3A30011C3H
1563	2210502028	E452A3A30011C3K
1564	2210502029	E452A3A30011C3L
1565	2210502030	E452A3A30011C3M
1566	2210502031	E452A3A30011C41
1567	2210502032	E452A3A30011C43
1568	2210502033	E452A3A30011C45
1569	2210502034	E452A3A30011C4A
1570	2210502035	E452A3A30011C4B
1571	2210502036	E452A3A30011C4C
1572	2210502037	E452A3A30011C4D
1573	2210502038	E452A3A30011C4E
1574	2210502039	E452A3A30011C4G
1575	2210502040	E452A3A30011C4K
1576	2210502041	E452A3A30011C4M
1577	2210502046	E452A3A30011E05
1578	N/A	N/A
1579	N/A	N/A
1580	N/A	N/A
1581	N/A	N/A
1582	2210502061	E452A3A30011R05
1583	N/A	N/A
1584	N/A	N/A
1585	N/A	N/A
1586	N/A	N/A
1587	N/A	N/A
1588	N/A	N/A
1589	N/A	N/A
1590	N/A	N/A
1591	N/A	N/A
1592	N/A	N/A
1593	2210502072	E452A3A30011R21
1594	2210502073	E452A3A30011R22
1595	2210502074	E452A3A30011R23
1596	2210502075	E452A3A30011R24
1597	2210502076	E452A3A30011R25
1598	2210502077	E452A3A30011R2A
1599	2210502078	E452A3A30011R2B
1600	2210502079	E452A3A30011R2C

Pos.	Molex PN:	Engineering No.:
1601	2210502080	E452A3A30011R2D
1602	2210502081	E452A3A30011R2E
1603	2210502082	E452A3A30011R2G
1604	2210502083	E452A3A30011R2H
1605	2210502084	E452A3A30011R2K
1606	2210502085	E452A3A30011R2M
1607	2210502086	E452A3A30011S01
1608	2210502087	E452A3A30011S02
1609	2210502088	E452A3A30011S03
1610	2210502089	E452A3A30011S04
1611	2210502090	E452A3A30011S05
1612	2210502091	E452A3A30011S0A
1613	2210502092	E452A3A30011S0B
1614	2210502093	E452A3A30011S0C
1615	2210502094	E452A3A30011S0D
1616	2210502095	E452A3A30011S0E
1617	2210502096	E452A3A30011S0G
1618	2210502097	E452A3A30011S0K
1619	2210502098	E452A3A30011S0L
1620	2210502099	E452A3A30011S0M
1621	2210502100	E452A3A50011000
1622	2210502101	E452A3A50011A11
1623	2210502102	E452A3A50011A12
1624	2210502103	E452A3A50011A13
1625	2210502104	E452A3A50011A14
1626	2210502105	E452A3A50011A15
1627	2210502106	E452A3A50011A1A
1628	2210502107	E452A3A50011A1B
1629	2210502108	E452A3A50011A1C
1630	2210502109	E452A3A50011A1D
1631	2210502110	E452A3A50011A1E
1632	2210502111	E452A3A50011A1G
1633	2210502112	E452A3A50011A1H
1634	2210502113	E452A3A50011A1K
1635	2210502114	E452A3A50011A1L
1636	2210502115	E452A3A50011A1M
1637	2210502116	E452A3A50011C31
1638	2210502117	E452A3A50011C32
1639	2210502118	E452A3A50011C33
1640	2210502119	E452A3A50011C34

THIS DRAWING CONTAINS INFORMATION THAT IS PROPRIETARY TO MOLEX ELECTRONIC TECHNOLOGIES, LLC AND SHOULD NOT BE USED WITHOUT WRITTEN PERMISSION											
DIMENSION UNITS		SCALE		CURRENT REV DESC: REVISION CREATED FOR REMOVING PRE-RELEASE STAMP							
mm		NTS									
GENERAL TOLERANCES (UNLESS SPECIFIED)				EC NO: 714567 DRWN: SUGEEB 2022/07/18 CHK'D: GGA 2022/07/19 APPR: GGA 2022/07/19		E452XXXXXXXXXX DIN FORM A EN 175301-803					
		MM								INCH	
4 PLACES ±		±								±	
3 PLACES ±		±								±	
2 PLACES ±		±								±	
1 PLACE ±		±								±	
0 PLACES ±		±		±		INITIAL REVISION:					
ANGULAR TOL ± °				DRWN: JMARSZALEK 2012/08/27		APPR: MDYSZEWSKA 2012/08/20		DOCUMENT NUMBER			
DRAFT WHERE APPLICABLE MUST REMAIN WITHIN DIMENSIONS				FIRST ANGLE PROJECTION		DRAWING		SERIES			
						A3-SIZE		121050			
				MATERIAL NUMBER		CUSTOMER		SHEET NUMBER			
				SEE TABLE		GENERAL MARKET		13 OF 41			

TABLE 3 - PART LIST

Pos.	Molex PN:	Engineering No.:
1641	2210502120	E452A3A50011C35
1642	2210502121	E452A3A50011C3A
1643	2210502122	E452A3A50011C3B
1644	2210502123	E452A3A50011C3C
1645	2210502124	E452A3A50011C3D
1646	2210502125	E452A3A50011C3E
1647	2210502126	E452A3A50011C3G
1648	2210502127	E452A3A50011C3H
1649	2210502128	E452A3A50011C3K
1650	2210502129	E452A3A50011C3L
1651	2210502130	E452A3A50011C3M
1652	2210502131	E452A3A50011C41
1653	2210502132	E452A3A50011C42
1654	2210502133	E452A3A50011C43
1655	2210502134	E452A3A50011C45
1656	2210502135	E452A3A50011C4A
1657	2210502136	E452A3A50011C4B
1658	2210502137	E452A3A50011C4C
1659	2210502138	E452A3A50011C4D
1660	2210502139	E452A3A50011C4E
1661	2210502140	E452A3A50011C4G
1662	2210502141	E452A3A50011C4H
1663	2210502142	E452A3A50011C4K
1664	2210502143	E452A3A50011C4L
1665	2210502144	E452A3A50011C4M
1666	2210502149	E452A3A50011E05
1667	N/A	N/A
1668	N/A	N/A
1669	N/A	N/A
1670	N/A	N/A
1671	2210502164	E452A3A50011R05
1672	N/A	N/A
1673	N/A	N/A
1674	N/A	N/A
1675	N/A	N/A
1676	N/A	N/A
1677	N/A	N/A
1678	N/A	N/A
1679	N/A	N/A
1680	N/A	N/A

Pos.	Molex PN:	Engineering No.:
1681	N/A	N/A
1682	2210502175	E452A3A50011R21
1683	2210502176	E452A3A50011R22
1684	2210502177	E452A3A50011R23
1685	2210502178	E452A3A50011R24
1686	2210502179	E452A3A50011R25
1687	2210502180	E452A3A50011R2A
1688	2210502181	E452A3A50011R2B
1689	2210502182	E452A3A50011R2C
1690	2210502183	E452A3A50011R2D
1691	2210502184	E452A3A50011R2E
1692	2210502185	E452A3A50011R2G
1693	2210502186	E452A3A50011R2H
1694	2210502187	E452A3A50011R2K
1695	2210502188	E452A3A50011R2M
1696	2210502189	E452A3A50011S01
1697	2210502190	E452A3A50011S02
1698	2210502191	E452A3A50011S03
1699	2210502192	E452A3A50011S04
1700	2210502193	E452A3A50011S05
1701	2210502194	E452A3A50011S0A
1702	2210502195	E452A3A50011S0B
1703	2210502196	E452A3A50011S0C
1704	2210502197	E452A3A50011S0D
1705	2210502198	E452A3A50011S0E
1706	2210502199	E452A3A50011S0G
1707	2210502200	E452A3A50011S0K
1708	2210502201	E452A3A50011S0L
1709	2210502202	E452A3A50011S0M
1710	2210502203	E452B2A10011000
1711	2210502204	E452B2A10011A11
1712	2210502205	E452B2A10011A12
1713	2210502206	E452B2A10011A13
1714	2210502207	E452B2A10011A14
1715	2210502208	E452B2A10011A15
1716	2210502209	E452B2A10011A1A
1717	2210502210	E452B2A10011A1B
1718	2210502211	E452B2A10011A1C
1719	2210502212	E452B2A10011A1D
1720	2210502213	E452B2A10011A1E

Pos.	Molex PN:	Engineering No.:
1721	2210502214	E452B2A10011A1G
1722	2210502215	E452B2A10011A1H
1723	2210502216	E452B2A10011A1K
1724	2210502217	E452B2A10011A1L
1725	2210502218	E452B2A10011A1M
1726	2210502219	E452B2A10011C31
1727	2210502220	E452B2A10011C32
1728	2210502221	E452B2A10011C33
1729	2210502222	E452B2A10011C34
1730	2210502223	E452B2A10011C35
1731	2210502224	E452B2A10011C3A
1732	2210502225	E452B2A10011C3B
1733	2210502226	E452B2A10011C3C
1734	2210502227	E452B2A10011C3D
1735	2210502228	E452B2A10011C3E
1736	2210502229	E452B2A10011C3G
1737	2210502230	E452B2A10011C3H
1738	2210502231	E452B2A10011C3K
1739	2210502232	E452B2A10011C3L
1740	2210502233	E452B2A10011C3M
1741	2210502234	E452B2A10011C41
1742	2210502235	E452B2A10011C42
1743	2210502236	E452B2A10011C43
1744	2210502237	E452B2A10011C44
1745	2210502238	E452B2A10011C45
1746	2210502239	E452B2A10011C4A
1747	2210502240	E452B2A10011C4B
1748	2210502241	E452B2A10011C4C
1749	2210502242	E452B2A10011C4D
1750	2210502243	E452B2A10011C4E
1751	2210502244	E452B2A10011C4G
1752	2210502245	E452B2A10011C4H
1753	2210502246	E452B2A10011C4K
1754	2210502247	E452B2A10011C4L
1755	2210502248	E452B2A10011C4M
1756	2210502253	E452B2A10011E05
1757	N/A	N/A
1758	N/A	N/A
1759	N/A	N/A
1760	N/A	N/A

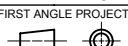
Pos.	Molex PN:	Engineering No.:
1761	2210502268	E452B2A10011R05
1762	N/A	N/A
1763	N/A	N/A
1764	N/A	N/A
1765	N/A	N/A
1766	N/A	N/A
1767	N/A	N/A
1768	N/A	N/A
1769	N/A	N/A
1770	N/A	N/A
1771	N/A	N/A
1772	2210502279	E452B2A10011R21
1773	2210502280	E452B2A10011R22
1774	2210502281	E452B2A10011R23
1775	2210502282	E452B2A10011R24
1776	2210502283	E452B2A10011R25
1777	2210502284	E452B2A10011R2A
1778	2210502285	E452B2A10011R2B
1779	2210502286	E452B2A10011R2C
1780	2210502287	E452B2A10011R2D
1781	2210502288	E452B2A10011R2E
1782	2210502289	E452B2A10011R2G
1783	2210502290	E452B2A10011R2H
1784	2210502291	E452B2A10011R2K
1785	2210502292	E452B2A10011R2L
1786	2210502293	E452B2A10011R2M
1787	2210502294	E452B2A10011S01
1788	2210502295	E452B2A10011S02
1789	2210502296	E452B2A10011S03
1790	2210502297	E452B2A10011S04
1791	2210502298	E452B2A10011S05
1792	2210502299	E452B2A10011S0A
1793	2210502300	E452B2A10011S0B
1794	2210502301	E452B2A10011S0C
1795	2210502302	E452B2A10011S0D
1796	2210502303	E452B2A10011S0E
1797	2210502304	E452B2A10011S0G
1798	2210502305	E452B2A10011S0H
1799	2210502306	E452B2A10011S0K
1800	2210502307	E452B2A10011S0L

THIS DRAWING CONTAINS INFORMATION THAT IS PROPRIETARY TO MOLEX ELECTRONIC TECHNOLOGIES, LLC AND SHOULD NOT BE USED WITHOUT WRITTEN PERMISSION									
DIMENSION UNITS		SCALE		CURRENT REV DESC: REVISION CREATED FOR REMOVING PRE-RELEASE STAMP				 E452XXXXXXXXXX DIN FORM A EN 175301-803	
mm		NTS							
GENERAL TOLERANCES (UNLESS SPECIFIED)				EC NO: 714567		2022/07/18		PRODUCT CUSTOMER DRAWING	
				DRWN: SUGEEB		2022/07/19			
				CHK'D: GGA		2022/07/19		DOCUMENT NUMBER	
				APPR: GGA		2022/07/19			
				INITIAL REVISION:				SD-121050-001	
				DRWN: JMARSZALEK		2012/08/27			
				APPR: MDYSZEWSKA		2012/08/20		DOC TYPE DOC PART REVISION	
				ANGULAR TOL				PSD 001 E1	
DRAFT WHERE APPLICABLE MUST REMAIN WITHIN DIMENSIONS				FIRST ANGLE PROJECTION		DRAWING		SHEET NUMBER	
						A3-SIZE		121050	
				MATERIAL NUMBER		CUSTOMER		SEE TABLE GENERAL MARKET	
								14 OF 41	

TABLE 3 - PART LIST

Pos.	Molex PN:	Engineering No.:
1961	2210502496	E452B2A15011R2A
1962	2210502497	E452B2A15011R2B
1963	2210502498	E452B2A15011R2C
1964	2210502499	E452B2A15011R2D
1965	2210502500	E452B2A15011R2E
1966	2210502501	E452B2A15011R2G
1967	2210502502	E452B2A15011R2H
1968	2210502503	E452B2A15011R2K
1969	2210502504	E452B2A15011R2L
1970	2210502505	E452B2A15011R2M
1971	2210502506	E452B2A15011S01
1972	2210502507	E452B2A15011S02
1973	2210502508	E452B2A15011S03
1974	2210502509	E452B2A15011S04
1975	2210502510	E452B2A15011S05
1976	2210502511	E452B2A15011S0A
1977	2210502512	E452B2A15011S0B
1978	2210502513	E452B2A15011S0C
1979	2210502514	E452B2A15011S0D
1980	2210502515	E452B2A15011S0E
1981	2210502516	E452B2A15011S0G
1982	2210502517	E452B2A15011S0H
1983	2210502518	E452B2A15011S0K
1984	2210502519	E452B2A15011S0L
1985	2210502520	E452B2A15011S0M
1986	2210502521	E452B2A20011000
1987	2210502522	E452B2A20011A11
1988	2210502523	E452B2A20011A12
1989	2210502524	E452B2A20011A13
1990	2210502525	E452B2A20011A14
1991	2210502526	E452B2A20011A15
1992	2210502527	E452B2A20011A1A
1993	2210502528	E452B2A20011A1B
1994	2210502529	E452B2A20011A1C
1995	2210502530	E452B2A20011A1D
1996	2210502531	E452B2A20011A1E
1997	2210502532	E452B2A20011A1G
1998	2210502533	E452B2A20011A1H
1999	2210502534	E452B2A20011A1K
2000	2210502535	E452B2A20011A1L

Pos.	Molex PN:	Engineering No.:
2001	2210502536	E452B2A20011A1M
2002	2210502537	E452B2A20011C31
2003	2210502538	E452B2A20011C32
2004	2210502539	E452B2A20011C33
2005	2210502540	E452B2A20011C34
2006	2210502541	E452B2A20011C35
2007	2210502542	E452B2A20011C3A
2008	2210502543	E452B2A20011C3B
2009	2210502544	E452B2A20011C3C
2010	2210502545	E452B2A20011C3D
2011	2210502546	E452B2A20011C3E
2012	2210502547	E452B2A20011C3G
2013	2210502548	E452B2A20011C3H
2014	2210502549	E452B2A20011C3K
2015	2210502550	E452B2A20011C3L
2016	2210502551	E452B2A20011C3M
2017	2210502552	E452B2A20011C41
2018	2210502553	E452B2A20011C42
2019	2210502554	E452B2A20011C43
2020	2210502555	E452B2A20011C44
2021	2210502556	E452B2A20011C45
2022	2210502557	E452B2A20011C4A
2023	2210502558	E452B2A20011C4B
2024	2210502559	E452B2A20011C4C
2025	2210502560	E452B2A20011C4D
2026	2210502561	E452B2A20011C4E
2027	2210502562	E452B2A20011C4G
2028	2210502563	E452B2A20011C4H
2029	2210502564	E452B2A20011C4K
2030	2210502565	E452B2A20011C4L
2031	2210502566	E452B2A20011C4M
2032	2210502571	E452B2A20011E05
2033	N/A	N/A
2034	N/A	N/A
2035	N/A	N/A
2036	N/A	N/A
2037	2210502586	E452B2A20011R05
2038	N/A	N/A
2039	N/A	N/A
2040	N/A	N/A

Pos.	Molex PN:	Engineering No.:
2041	N/A	N/A
2042	N/A	N/A
2043	N/A	N/A
2044	N/A	N/A
2045	N/A	N/A
2046	N/A	N/A
2047	N/A	N/A
2048	2210502597	E452B2A20011R21
2049	2210502598	E452B2A20011R22
2050	2210502599	E452B2A20011R23
2051	2210502600	E452B2A20011R24
2052	2210502601	E452B2A20011R25
2053	2210502602	E452B2A20011R2A
2054	2210502603	E452B2A20011R2B
2055	2210502604	E452B2A20011R2C
2056	2210502605	E452B2A20011R2D
2057	2210502606	E452B2A20011R2E
2058	2210502607	E452B2A20011R2G
2059	2210502608	E452B2A20011R2H
2060	2210502609	E452B2A20011R2K
2061	2210502610	E452B2A20011R2L
2062	2210502611	E452B2A20011R2M
2063	2210502612	E452B2A20011S01
2064	2210502613	E452B2A20011S02
2065	2210502614	E452B2A20011S03
2066	2210502615	E452B2A20011S04
2067	2210502616	E452B2A20011S05
2068	2210502617	E452B2A20011S0A
2069	2210502618	E452B2A20011S0B
2070	2210502619	E452B2A20011S0C
2071	2210502620	E452B2A20011S0D
2072	2210502621	E452B2A20011S0E
2073	2210502622	E452B2A20011S0G
2074	2210502623	E452B2A20011S0H
2075	2210502624	E452B2A20011S0K
2076	2210502625	E452B2A20011S0L
2077	2210502626	E452B2A20011S0M
2078	2210502627	E452B2A30011000
2079	2210502628	E452B2A30011A11
2080	2210502629	E452B2A30011A12

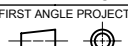
Pos.	Molex PN:	Engineering No.:
2081	2210502630	E452B2A30011A13
2082	2210502631	E452B2A30011A14
2083	2210502632	E452B2A30011A1A
2084	2210502633	E452B2A30011A1B
2085	2210502634	E452B2A30011A1C
2086	2210502635	E452B2A30011A1D
2087	2210502636	E452B2A30011A1E
2088	2210502637	E452B2A30011A1G
2089	2210502638	E452B2A30011A1H
2090	2210502639	E452B2A30011A1K
2091	2210502640	E452B2A30011A1L
2092	2210502641	E452B2A30011A1M
2093	2210502642	E452B2A30011C31
2094	2210502643	E452B2A30011C32
2095	2210502644	E452B2A30011C33
2096	2210502645	E452B2A30011C34
2097	2210502646	E452B2A30011C35
2098	2210502647	E452B2A30011C3A
2099	2210502648	E452B2A30011C3B
2100	2210502649	E452B2A30011C3C
2101	2210502650	E452B2A30011C3D
2102	2210502651	E452B2A30011C3E
2103	2210502652	E452B2A30011C3G
2104	2210502653	E452B2A30011C3H
2105	2210502654	E452B2A30011C3K
2106	2210502655	E452B2A30011C3L
2107	2210502656	E452B2A30011C3M
2108	2210502657	E452B2A30011C41
2109	2210502658	E452B2A30011C42
2110	2210502659	E452B2A30011C43
2111	2210502660	E452B2A30011C44
2112	2210502661	E452B2A30011C45
2113	2210502662	E452B2A30011C4A
2114	2210502663	E452B2A30011C4B
2115	2210502664	E452B2A30011C4C
2116	2210502665	E452B2A30011C4D
2117	2210502666	E452B2A30011C4E
2118	2210502667	E452B2A30011C4G
2119	2210502668	E452B2A30011C4H
2120	2210502669	E452B2A30011C4K

THIS DRAWING CONTAINS INFORMATION THAT IS PROPRIETARY TO MOLEX ELECTRONIC TECHNOLOGIES, LLC AND SHOULD NOT BE USED WITHOUT WRITTEN PERMISSION									
DIMENSION UNITS		SCALE		CURRENT REV DESC: REVISION CREATED FOR REMOVING PRE-RELEASE STAMP				 E452XXXXXXXXXX DIN FORM A EN 175301-803	
mm		NTS							
GENERAL TOLERANCES (UNLESS SPECIFIED)									
		MM		INCH					
4 PLACES		±		±					
3 PLACES		±		±					
2 PLACES		±		±					
1 PLACE		±		±					
0 PLACES		±		±					
ANGULAR TOL		±		°					
DRAFT WHERE APPLICABLE MUST REMAIN WITHIN DIMENSIONS				FIRST ANGLE PROJECTION		DRAWING		SERIES	
						A3-SIZE		121050	
				MATERIAL NUMBER		CUSTOMER		SHEET NUMBER	
				SEE TABLE		GENERAL MARKET		16 OF 41	
				DOCUMENT NUMBER		DOC TYPE		DOC PART	
				SD-121050-001		PSD		001	
				REVISION		E1			

TABLE 3 - PART LIST

Pos.	Molex PN:	Engineering No.:
2121	2210502670	E452B2A30011C4L
2122	2210502671	E452B2A30011C4M
2123	2210502676	E452B2A30011E05
2124	N/A	N/A
2125	N/A	N/A
2126	N/A	N/A
2127	N/A	N/A
2128	2210502691	E452B2A30011R05
2129	N/A	N/A
2130	N/A	N/A
2131	N/A	N/A
2132	N/A	N/A
2133	N/A	N/A
2134	N/A	N/A
2135	N/A	N/A
2136	N/A	N/A
2137	N/A	N/A
2138	N/A	N/A
2139	2210502702	E452B2A30011R21
2140	2210502703	E452B2A30011R22
2141	2210502704	E452B2A30011R23
2142	2210502705	E452B2A30011R24
2143	2210502706	E452B2A30011R25
2144	2210502707	E452B2A30011R2A
2145	2210502708	E452B2A30011R2B
2146	2210502709	E452B2A30011R2C
2147	2210502710	E452B2A30011R2D
2148	2210502711	E452B2A30011R2E
2149	2210502712	E452B2A30011R2G
2150	2210502713	E452B2A30011R2H
2151	2210502714	E452B2A30011R2K
2152	2210502715	E452B2A30011R2L
2153	2210502716	E452B2A30011R2M
2154	2210502717	E452B2A30011S01
2155	2210502718	E452B2A30011S02
2156	2210502719	E452B2A30011S03
2157	2210502720	E452B2A30011S04
2158	2210502721	E452B2A30011S05
2159	2210502722	E452B2A30011S0A
2160	2210502723	E452B2A30011S0B

Pos.	Molex PN:	Engineering No.:
2161	2210502724	E452B2A30011S0C
2162	2210502725	E452B2A30011S0D
2163	2210502726	E452B2A30011S0E
2164	2210502727	E452B2A30011S0G
2165	2210502728	E452B2A30011S0H
2166	2210502729	E452B2A30011S0K
2167	2210502730	E452B2A30011S0L
2168	2210502731	E452B2A30011S0M
2169	2210502732	E452B2A50011000
2170	2210502733	E452B2A50011A11
2171	2210502734	E452B2A50011A12
2172	2210502735	E452B2A50011A13
2173	2210502736	E452B2A50011A14
2174	2210502737	E452B2A50011A15
2175	2210502738	E452B2A50011A1A
2176	2210502739	E452B2A50011A1B
2177	2210502740	E452B2A50011A1C
2178	2210502741	E452B2A50011A1D
2179	2210502742	E452B2A50011A1E
2180	2210502743	E452B2A50011A1G
2181	2210502744	E452B2A50011A1H
2182	2210502745	E452B2A50011A1K
2183	2210502746	E452B2A50011A1L
2184	2210502747	E452B2A50011A1M
2185	2210502748	E452B2A50011C31
2186	2210502749	E452B2A50011C32
2187	2210502750	E452B2A50011C33
2188	2210502751	E452B2A50011C34
2189	2210502752	E452B2A50011C35
2190	2210502753	E452B2A50011C3A
2191	2210502754	E452B2A50011C3B
2192	2210502755	E452B2A50011C3C
2193	2210502756	E452B2A50011C3D
2194	2210502757	E452B2A50011C3E
2195	2210502758	E452B2A50011C3G
2196	2210502759	E452B2A50011C3H
2197	2210502760	E452B2A50011C3K
2198	2210502761	E452B2A50011C3L
2199	2210502762	E452B2A50011C3M
2200	2210502763	E452B2A50011C41

Pos.	Molex PN:	Engineering No.:
2201	2210502764	E452B2A50011C42
2202	2210502765	E452B2A50011C43
2203	2210502766	E452B2A50011C44
2204	2210502767	E452B2A50011C45
2205	2210502768	E452B2A50011C4A
2206	2210502769	E452B2A50011C4B
2207	2210502770	E452B2A50011C4C
2208	2210502771	E452B2A50011C4D
2209	2210502772	E452B2A50011C4E
2210	2210502773	E452B2A50011C4G
2211	2210502774	E452B2A50011C4K
2212	2210502775	E452B2A50011C4L
2213	2210502776	E452B2A50011C4M
2214	2210502781	E452B2A50011E05
2215	N/A	N/A
2216	N/A	N/A
2217	N/A	N/A
2218	N/A	N/A
2219	2210502796	E452B2A50011R05
2220	N/A	N/A
2221	N/A	N/A
2222	N/A	N/A
2223	N/A	N/A
2224	N/A	N/A
2225	N/A	N/A
2226	N/A	N/A
2227	N/A	N/A
2228	N/A	N/A
2229	N/A	N/A
2230	2210502807	E452B2A50011R21
2231	2210502808	E452B2A50011R22
2232	2210502809	E452B2A50011R23
2233	2210502810	E452B2A50011R24
2234	2210502811	E452B2A50011R25
2235	2210502812	E452B2A50011R2A
2236	2210502813	E452B2A50011R2B
2237	2210502814	E452B2A50011R2C
2238	2210502815	E452B2A50011R2D
2239	2210502816	E452B2A50011R2E
2240	2210502817	E452B2A50011R2G

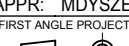
Pos.	Molex PN:	Engineering No.:
2241	2210502818	E452B2A50011R2H
2242	2210502819	E452B2A50011R2K
2243	2210502820	E452B2A50011R2L
2244	2210502821	E452B2A50011R2M
2245	2210502822	E452B2A50011S01
2246	2210502823	E452B2A50011S02
2247	2210502824	E452B2A50011S03
2248	2210502825	E452B2A50011S04
2249	2210502826	E452B2A50011S05
2250	2210502827	E452B2A50011S0A
2251	2210502828	E452B2A50011S0B
2252	2210502829	E452B2A50011S0C
2253	2210502830	E452B2A50011S0D
2254	2210502831	E452B2A50011S0E
2255	2210502832	E452B2A50011S0G
2256	2210502833	E452B2A50011S0H
2257	2210502834	E452B2A50011S0K
2258	2210502835	E452B2A50011S0L
2259	2210502836	E452B2A50011S0M
2260	2210502837	E452B3A10011000
2261	2210502838	E452B3A10011A11
2262	2210502839	E452B3A10011A12
2263	2210502840	E452B3A10011A13
2264	2210502841	E452B3A10011A14
2265	2210502842	E452B3A10011A15
2266	2210502843	E452B3A10011A1A
2267	2210502844	E452B3A10011A1B
2268	2210502845	E452B3A10011A1C
2269	2210502846	E452B3A10011A1D
2270	2210502847	E452B3A10011A1E
2271	2210502848	E452B3A10011A1G
2272	2210502849	E452B3A10011A1H
2273	2210502850	E452B3A10011A1K
2274	2210502851	E452B3A10011A1L
2275	2210502852	E452B3A10011A1M
2276	2210502853	E452B3A10011C31
2277	2210502854	E452B3A10011C32
2278	2210502855	E452B3A10011C33
2279	2210502856	E452B3A10011C34
2280	2210502857	E452B3A10011C35

THIS DRAWING CONTAINS INFORMATION THAT IS PROPRIETARY TO MOLEX ELECTRONIC TECHNOLOGIES, LLC AND SHOULD NOT BE USED WITHOUT WRITTEN PERMISSION		CURRENT REV DESC: REVISION CREATED FOR REMOVING PRE-RELEASE STAMP		 E452XXXXXXXXXX DIN FORM A EN 175301-803	
DIMENSION UNITS	SCALE	EC NO: 714567 DRWN: SUGEEB CHK'D: GGA APPR: GGA			
mm	NTS	2022/07/18 2022/07/19 2022/07/19		PRODUCT CUSTOMER DRAWING	
GENERAL TOLERANCES (UNLESS SPECIFIED)		INITIAL REVISION:		DOCUMENT NUMBER	
		DRWN: JMARSZALEK APPR: MDYSZEWSKA		SD-121050-001	
		2012/08/27 2012/08/20		DOC TYPE DOC PART REVISION	
		FIRST ANGLE PROJECTION		PSD 001 E1	
DRAFT WHERE APPLICABLE MUST REMAIN WITHIN DIMENSIONS		DRAWING		MATERIAL NUMBER	
		A3-SIZE		CUSTOMER	
		SERIES		GENERAL MARKET	
		121050		SHEET NUMBER	
				17 OF 41	

TABLE 3 - PART LIST

Pos.	Molex PN:	Engineering No.:
2281	2210502858	E452B3A10011C3A
2282	2210502859	E452B3A10011C3B
2283	2210502860	E452B3A10011C3C
2284	2210502861	E452B3A10011C3D
2285	2210502862	E452B3A10011C3E
2286	2210502863	E452B3A10011C3G
2287	2210502864	E452B3A10011C3H
2288	2210502865	E452B3A10011C3K
2289	2210502866	E452B3A10011C3L
2290	2210502867	E452B3A10011C3M
2291	2210502868	E452B3A10011C41
2292	2210502869	E452B3A10011C42
2293	2210502870	E452B3A10011C43
2294	2210502871	E452B3A10011C44
2295	2210502872	E452B3A10011C45
2296	2210502873	E452B3A10011C4A
2297	2210502874	E452B3A10011C4B
2298	2210502875	E452B3A10011C4C
2299	2210502876	E452B3A10011C4D
2300	2210502877	E452B3A10011C4E
2301	2210502878	E452B3A10011C4G
2302	2210502879	E452B3A10011C4H
2303	2210502880	E452B3A10011C4K
2304	2210502881	E452B3A10011C4L
2305	2210502882	E452B3A10011C4M
2306	2210502887	E452B3A10011E05
2307	N/A	N/A
2308	N/A	N/A
2309	N/A	N/A
2310	N/A	N/A
2311	2210502902	E452B3A10011R05
2312	N/A	N/A
2313	N/A	N/A
2314	N/A	N/A
2315	N/A	N/A
2316	N/A	N/A
2317	N/A	N/A
2318	N/A	N/A
2319	N/A	N/A
2320	N/A	N/A

Pos.	Molex PN:	Engineering No.:
2321	N/A	N/A
2322	2210502913	E452B3A10011R21
2323	2210502914	E452B3A10011R22
2324	2210502915	E452B3A10011R23
2325	2210502916	E452B3A10011R24
2326	2210502917	E452B3A10011R25
2327	2210502918	E452B3A10011R2A
2328	2210502919	E452B3A10011R2B
2329	2210502920	E452B3A10011R2C
2330	2210502921	E452B3A10011R2D
2331	2210502922	E452B3A10011R2E
2332	2210502923	E452B3A10011R2G
2333	2210502924	E452B3A10011R2H
2334	2210502925	E452B3A10011R2K
2335	2210502926	E452B3A10011R2L
2336	2210502927	E452B3A10011R2M
2337	2210502928	E452B3A10011S01
2338	2210502929	E452B3A10011S02
2339	2210502930	E452B3A10011S03
2340	2210502931	E452B3A10011S04
2341	2210502932	E452B3A10011S05
2342	2210502933	E452B3A10011S0A
2343	2210502934	E452B3A10011S0B
2344	2210502935	E452B3A10011S0C
2345	2210502936	E452B3A10011S0D
2346	2210502937	E452B3A10011S0E
2347	2210502938	E452B3A10011S0G
2348	2210502939	E452B3A10011S0H
2349	2210502940	E452B3A10011S0K
2350	2210502941	E452B3A10011S0L
2351	2210502942	E452B3A10011S0M
2352	2210502943	E452B3A10K11000
2353	2210502944	E452B3A10K11A11
2354	2210502945	E452B3A10K11A12
2355	2210502946	E452B3A10K11A13
2356	2210502947	E452B3A10K11A14
2357	2210502948	E452B3A10K11A15
2358	2210502949	E452B3A10K11A1A
2359	2210502950	E452B3A10K11A1B
2360	2210502951	E452B3A10K11A1C

Pos.	Molex PN:	Engineering No.:
2361	2210502952	E452B3A10K11A1D
2362	2210502953	E452B3A10K11A1E
2363	2210502954	E452B3A10K11A1G
2364	2210502955	E452B3A10K11A1H
2365	2210502956	E452B3A10K11A1K
2366	2210502957	E452B3A10K11A1L
2367	2210502958	E452B3A10K11A1M
2368	2210502959	E452B3A10K11C31
2369	2210502960	E452B3A10K11C32
2370	2210502961	E452B3A10K11C33
2371	2210502962	E452B3A10K11C34
2372	2210502963	E452B3A10K11C35
2373	2210502964	E452B3A10K11C3A
2374	2210502965	E452B3A10K11C3B
2375	2210502966	E452B3A10K11C3C
2376	2210502967	E452B3A10K11C3D
2377	2210502968	E452B3A10K11C3E
2378	2210502969	E452B3A10K11C3G
2379	2210502970	E452B3A10K11C3H
2380	2210502971	E452B3A10K11C3K
2381	2210502972	E452B3A10K11C3L
2382	2210502973	E452B3A10K11C3M
2383	2210502974	E452B3A10K11C41
2384	2210502975	E452B3A10K11C42
2385	2210502976	E452B3A10K11C43
2386	2210502977	E452B3A10K11C44
2387	2210502978	E452B3A10K11C45
2388	2210502979	E452B3A10K11C4A
2389	2210502980	E452B3A10K11C4B
2390	2210502981	E452B3A10K11C4C
2391	2210502982	E452B3A10K11C4D
2392	2210502983	E452B3A10K11C4E
2393	2210502984	E452B3A10K11C4G
2394	2210502985	E452B3A10K11C4H
2395	2210502986	E452B3A10K11C4K
2396	2210502987	E452B3A10K11C4L
2397	2210502988	E452B3A10K11C4M
2398	2210502993	E452B3A10K11E05
2399	N/A	N/A
2400	N/A	N/A

Pos.	Molex PN:	Engineering No.:
2401	N/A	N/A
2402	N/A	N/A
2403	2210503008	E452B3A10K11R05
2404	N/A	N/A
2405	N/A	N/A
2406	N/A	N/A
2407	N/A	N/A
2408	N/A	N/A
2409	N/A	N/A
2410	N/A	N/A
2411	N/A	N/A
2412	N/A	N/A
2413	N/A	N/A
2414	2210503019	E452B3A10K11R21
2415	2210503020	E452B3A10K11R22
2416	2210503021	E452B3A10K11R23
2417	2210503022	E452B3A10K11R24
2418	2210503023	E452B3A10K11R25
2419	2210503024	E452B3A10K11R2A
2420	2210503025	E452B3A10K11R2B
2421	2210503026	E452B3A10K11R2C
2422	2210503027	E452B3A10K11R2D
2423	2210503028	E452B3A10K11R2E
2424	2210503029	E452B3A10K11R2G
2425	2210503030	E452B3A10K11R2H
2426	2210503031	E452B3A10K11R2K
2427	2210503032	E452B3A10K11R2L
2428	2210503033	E452B3A10K11R2M
2429	2210503034	E452B3A10K11S01
2430	2210503035	E452B3A10K11S02
2431	2210503036	E452B3A10K11S03
2432	2210503037	E452B3A10K11S04
2433	2210503038	E452B3A10K11S05
2434	2210503039	E452B3A10K11S0A
2435	2210503040	E452B3A10K11S0B
2436	2210503041	E452B3A10K11S0C
2437	2210503042	E452B3A10K11S0D
2438	2210503043	E452B3A10K11S0E
2439	2210503044	E452B3A10K11S0G
2440	2210503045	E452B3A10K11S0H

THIS DRAWING CONTAINS INFORMATION THAT IS PROPRIETARY TO MOLEX ELECTRONIC TECHNOLOGIES, LLC AND SHOULD NOT BE USED WITHOUT WRITTEN PERMISSION									
DIMENSION UNITS		SCALE		CURRENT REV DESC: REVISION CREATED FOR REMOVING PRE-RELEASE STAMP				 E452XXXXXXXXXX DIN FORM A EN 175301-803	
mm		NTS							
GENERAL TOLERANCES (UNLESS SPECIFIED)				EC NO: 714567		DRWN: SUGEEB		2022/07/18	
				CHK'D: GGA		APPR: GGA		2022/07/19	
				INITIAL REVISION:		DRWN: JMARSZALEK		2012/08/27	
				APPR: MDYSZEWSKA		2012/08/20		SD-121050-001	
DRAFT WHERE APPLICABLE MUST REMAIN WITHIN DIMENSIONS				FIRST ANGLE PROJECTION		DRAWING		SERIES	
						A3-SIZE		121050	
				MATERIAL NUMBER		CUSTOMER		SHEET NUMBER	
				SEE TABLE		GENERAL MARKET		18 OF 41	

TABLE 3 - PART LIST

Pos.	Molex PN:	Engineering No.:
2441	2210503046	E452B3A10K11S0K
2442	2210503047	E452B3A10K11S0L
2443	2210503048	E452B3A10K11S0M
2444	2210503049	E452B3A15011000
2445	2210503050	E452B3A15011A11
2446	2210503051	E452B3A15011A12
2447	2210503052	E452B3A15011A13
2448	2210503053	E452B3A15011A14
2449	2210503054	E452B3A15011A15
2450	2210503055	E452B3A15011A1A
2451	2210503056	E452B3A15011A1B
2452	2210503057	E452B3A15011A1C
2453	2210503058	E452B3A15011A1D
2454	2210503059	E452B3A15011A1E
2455	2210503060	E452B3A15011A1G
2456	2210503061	E452B3A15011A1H
2457	2210503062	E452B3A15011A1K
2458	2210503063	E452B3A15011A1L
2459	2210503064	E452B3A15011A1M
2460	2210503065	E452B3A15011C31
2461	2210503066	E452B3A15011C32
2462	2210503067	E452B3A15011C33
2463	2210503068	E452B3A15011C34
2464	2210503069	E452B3A15011C35
2465	2210503070	E452B3A15011C3A
2466	2210503071	E452B3A15011C3B
2467	2210503072	E452B3A15011C3C
2468	2210503073	E452B3A15011C3D
2469	2210503074	E452B3A15011C3E
2470	2210503075	E452B3A15011C3G
2471	2210503076	E452B3A15011C3H
2472	2210503077	E452B3A15011C3K
2473	2210503078	E452B3A15011C3L
2474	2210503079	E452B3A15011C3M
2475	2210503080	E452B3A15011C41
2476	2210503081	E452B3A15011C42
2477	2210503082	E452B3A15011C43
2478	2210503083	E452B3A15011C44
2479	2210503084	E452B3A15011C45
2480	2210503085	E452B3A15011C4A

Pos.	Molex PN:	Engineering No.:
2481	2210503086	E452B3A15011C4B
2482	2210503087	E452B3A15011C4C
2483	2210503088	E452B3A15011C4D
2484	2210503089	E452B3A15011C4E
2485	2210503090	E452B3A15011C4G
2486	2210503091	E452B3A15011C4H
2487	2210503092	E452B3A15011C4K
2488	2210503093	E452B3A15011C4L
2489	2210503094	E452B3A15011C4M
2490	2210503099	E452B3A15011E05
2491	N/A	N/A
2492	N/A	N/A
2493	N/A	N/A
2494	N/A	N/A
2495	2210503114	E452B3A15011R05
2496	N/A	N/A
2497	N/A	N/A
2498	N/A	N/A
2499	N/A	N/A
2500	N/A	N/A
2501	N/A	N/A
2502	N/A	N/A
2503	N/A	N/A
2504	N/A	N/A
2505	N/A	N/A
2506	2210503125	E452B3A15011R21
2507	2210503126	E452B3A15011R22
2508	2210503127	E452B3A15011R23
2509	2210503128	E452B3A15011R24
2510	2210503129	E452B3A15011R25
2511	2210503130	E452B3A15011R2A
2512	2210503131	E452B3A15011R2B
2513	2210503132	E452B3A15011R2C
2514	2210503133	E452B3A15011R2D
2515	2210503134	E452B3A15011R2E
2516	2210503135	E452B3A15011R2G
2517	2210503136	E452B3A15011R2H
2518	2210503137	E452B3A15011R2K
2519	2210503138	E452B3A15011R2L
2520	2210503139	E452B3A15011R2M

Pos.	Molex PN:	Engineering No.:
2521	2210503140	E452B3A15011S01
2522	2210503141	E452B3A15011S02
2523	2210503142	E452B3A15011S03
2524	2210503143	E452B3A15011S04
2525	2210503144	E452B3A15011S05
2526	2210503145	E452B3A15011S0A
2527	2210503146	E452B3A15011S0B
2528	2210503147	E452B3A15011S0C
2529	2210503148	E452B3A15011S0D
2530	2210503149	E452B3A15011S0E
2531	2210503150	E452B3A15011S0G
2532	2210503151	E452B3A15011S0H
2533	2210503152	E452B3A15011S0K
2534	2210503153	E452B3A15011S0L
2535	2210503154	E452B3A15011S0M
2536	2210503155	E452B3A20011000
2537	2210503156	E452B3A20011A11
2538	2210503157	E452B3A20011A12
2539	2210503158	E452B3A20011A13
2540	2210503159	E452B3A20011A14
2541	2210503160	E452B3A20011A15
2542	2210503161	E452B3A20011A1A
2543	2210503162	E452B3A20011A1B
2544	2210503163	E452B3A20011A1C
2545	2210503164	E452B3A20011A1D
2546	2210503165	E452B3A20011A1E
2547	2210503166	E452B3A20011A1G
2548	2210503167	E452B3A20011A1H
2549	2210503168	E452B3A20011A1K
2550	2210503169	E452B3A20011A1L
2551	2210503170	E452B3A20011A1M
2552	2210503171	E452B3A20011C31
2553	2210503172	E452B3A20011C32
2554	2210503173	E452B3A20011C33
2555	2210503174	E452B3A20011C34
2556	2210503175	E452B3A20011C35
2557	2210503176	E452B3A20011C3A
2558	2210503177	E452B3A20011C3B
2559	2210503178	E452B3A20011C3C
2560	2210503179	E452B3A20011C3D

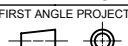
Pos.	Molex PN:	Engineering No.:
2561	2210503180	E452B3A20011C3E
2562	2210503181	E452B3A20011C3G
2563	2210503182	E452B3A20011C3H
2564	2210503183	E452B3A20011C3K
2565	2210503184	E452B3A20011C3L
2566	2210503185	E452B3A20011C3M
2567	2210503186	E452B3A20011C41
2568	2210503187	E452B3A20011C42
2569	2210503188	E452B3A20011C43
2570	2210503189	E452B3A20011C44
2571	2210503190	E452B3A20011C45
2572	2210503191	E452B3A20011C4A
2573	2210503192	E452B3A20011C4B
2574	2210503193	E452B3A20011C4C
2575	2210503194	E452B3A20011C4D
2576	2210503195	E452B3A20011C4E
2577	2210503196	E452B3A20011C4G
2578	2210503197	E452B3A20011C4H
2579	2210503198	E452B3A20011C4K
2580	2210503199	E452B3A20011C4L
2581	2210503200	E452B3A20011C4M
2582	2210503205	E452B3A20011E05
2583	N/A	N/A
2584	N/A	N/A
2585	N/A	N/A
2586	N/A	N/A
2587	2210503220	E452B3A20011R05
2588	N/A	N/A
2589	N/A	N/A
2590	N/A	N/A
2591	N/A	N/A
2592	N/A	N/A
2593	N/A	N/A
2594	N/A	N/A
2595	N/A	N/A
2596	N/A	N/A
2597	N/A	N/A
2598	2210503231	E452B3A20011R21
2599	2210503232	E452B3A20011R22
2600	2210503233	E452B3A20011R23

THIS DRAWING CONTAINS INFORMATION THAT IS PROPRIETARY TO MOLEX ELECTRONIC TECHNOLOGIES, LLC AND SHOULD NOT BE USED WITHOUT WRITTEN PERMISSION									
DIMENSION UNITS		SCALE		CURRENT REV DESC: REVISION CREATED FOR REMOVING PRE-RELEASE STAMP				 E452XXXXXXXXXX DIN FORM A EN 175301-803	
mm		NTS							
GENERAL TOLERANCES (UNLESS SPECIFIED)				EC NO: 714567		2022/07/18		PRODUCT CUSTOMER DRAWING DOCUMENT NUMBER: SD-121050-001 DOC TYPE: PSD DOC PART: 001 REVISION: E1	
				DRWN: SUGEEB		2022/07/19			
				CHK'D: GGA		2022/07/19			
				APPR: GGA					
				INITIAL REVISION:					
				DRWN: JMARSZALEK		2012/08/27			
				APPR: MDYSZEWSKA		2012/08/20			
DRAFT WHERE APPLICABLE MUST REMAIN WITHIN DIMENSIONS				FIRST ANGLE PROJECTION		DRAWING		SHEET NUMBER	
						A3-SIZE		121050	
				SERIES		MATERIAL NUMBER		CUSTOMER	
						SEE TABLE		GENERAL MARKET	
								19 OF 41	

TABLE 3 - PART LIST

Pos.	Molex PN:	Engineering No.:
2601	2210503234	E452B3A20011R24
2602	2210503235	E452B3A20011R25
2603	2210503236	E452B3A20011R2A
2604	2210503237	E452B3A20011R2B
2605	2210503238	E452B3A20011R2C
2606	2210503239	E452B3A20011R2D
2607	2210503240	E452B3A20011R2E
2608	2210503241	E452B3A20011R2G
2609	2210503242	E452B3A20011R2H
2610	2210503243	E452B3A20011R2K
2611	2210503244	E452B3A20011R2L
2612	2210503245	E452B3A20011R2M
2613	2210503246	E452B3A20011S01
2614	2210503247	E452B3A20011S02
2615	2210503248	E452B3A20011S03
2616	2210503249	E452B3A20011S04
2617	2210503250	E452B3A20011S05
2618	2210503251	E452B3A20011S0A
2619	2210503252	E452B3A20011S0B
2620	2210503253	E452B3A20011S0C
2621	2210503254	E452B3A20011S0D
2622	2210503255	E452B3A20011S0E
2623	2210503256	E452B3A20011S0G
2624	2210503257	E452B3A20011S0H
2625	2210503258	E452B3A20011S0K
2626	2210503259	E452B3A20011S0L
2627	2210503260	E452B3A20011S0M
2628	2210503261	E452B3A30011000
2629	2210503262	E452B3A30011A11
2630	2210503263	E452B3A30011A12
2631	2210503264	E452B3A30011A13
2632	2210503265	E452B3A30011A14
2633	2210503266	E452B3A30011A15
2634	2210503267	E452B3A30011A1A
2635	2210503268	E452B3A30011A1B
2636	2210503269	E452B3A30011A1C
2637	2210503270	E452B3A30011A1D
2638	2210503271	E452B3A30011A1E
2639	2210503272	E452B3A30011A1G
2640	2210503273	E452B3A30011A1H

Pos.	Molex PN:	Engineering No.:
2641	2210503274	E452B3A30011A1K
2642	2210503275	E452B3A30011A1L
2643	2210503276	E452B3A30011A1M
2644	2210503277	E452B3A30011C31
2645	2210503278	E452B3A30011C32
2646	2210503279	E452B3A30011C33
2647	2210503280	E452B3A30011C34
2648	2210503281	E452B3A30011C35
2649	2210503282	E452B3A30011C3A
2650	2210503283	E452B3A30011C3B
2651	2210503284	E452B3A30011C3C
2652	2210503285	E452B3A30011C3D
2653	2210503286	E452B3A30011C3E
2654	2210503287	E452B3A30011C3G
2655	2210503288	E452B3A30011C3H
2656	2210503289	E452B3A30011C3K
2657	2210503290	E452B3A30011C3L
2658	2210503291	E452B3A30011C3M
2659	2210503292	E452B3A30011C41
2660	2210503293	E452B3A30011C42
2661	2210503294	E452B3A30011C43
2662	2210503295	E452B3A30011C44
2663	2210503296	E452B3A30011C45
2664	2210503297	E452B3A30011C4A
2665	2210503298	E452B3A30011C4B
2666	2210503299	E452B3A30011C4C
2667	2210503300	E452B3A30011C4D
2668	2210503301	E452B3A30011C4E
2669	2210503302	E452B3A30011C4G
2670	2210503303	E452B3A30011C4K
2671	2210503304	E452B3A30011C4L
2672	2210503305	E452B3A30011C4M
2673	2210503310	E452B3A30011E05
2674	N/A	N/A
2675	N/A	N/A
2676	N/A	N/A
2677	N/A	N/A
2678	2210503325	E452B3A30011R05
2679	N/A	N/A
2680	N/A	N/A

Pos.	Molex PN:	Engineering No.:
2681	N/A	N/A
2682	N/A	N/A
2683	N/A	N/A
2684	N/A	N/A
2685	N/A	N/A
2686	N/A	N/A
2687	N/A	N/A
2688	N/A	N/A
2689	2210503336	E452B3A30011R21
2690	2210503337	E452B3A30011R22
2691	2210503338	E452B3A30011R23
2692	2210503339	E452B3A30011R24
2693	2210503340	E452B3A30011R25
2694	2210503341	E452B3A30011R2A
2695	2210503342	E452B3A30011R2B
2696	2210503343	E452B3A30011R2C
2697	2210503344	E452B3A30011R2D
2698	2210503345	E452B3A30011R2E
2699	2210503346	E452B3A30011R2G
2700	2210503347	E452B3A30011R2H
2701	2210503348	E452B3A30011R2K
2702	2210503349	E452B3A30011R2L
2703	2210503350	E452B3A30011R2M
2704	2210503351	E452B3A30011S01
2705	2210503352	E452B3A30011S02
2706	2210503353	E452B3A30011S03
2707	2210503354	E452B3A30011S04
2708	2210503355	E452B3A30011S05
2709	2210503356	E452B3A30011S0A
2710	2210503357	E452B3A30011S0B
2711	2210503358	E452B3A30011S0C
2712	2210503359	E452B3A30011S0D
2713	2210503360	E452B3A30011S0E
2714	2210503361	E452B3A30011S0G
2715	2210503362	E452B3A30011S0K
2716	2210503363	E452B3A30011S0L
2717	2210503364	E452B3A30011S0M
2718	2210503365	E452B3A50011000
2719	2210503366	E452B3A50011A11
2720	2210503367	E452B3A50011A12

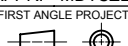
Pos.	Molex PN:	Engineering No.:
2721	2210503368	E452B3A50011A13
2722	2210503369	E452B3A50011A14
2723	2210503370	E452B3A50011A15
2724	2210503371	E452B3A50011A1A
2725	2210503372	E452B3A50011A1B
2726	2210503373	E452B3A50011A1C
2727	2210503374	E452B3A50011A1D
2728	2210503375	E452B3A50011A1E
2729	2210503376	E452B3A50011A1G
2730	2210503377	E452B3A50011A1H
2731	2210503378	E452B3A50011A1K
2732	2210503379	E452B3A50011A1L
2733	2210503380	E452B3A50011A1M
2734	2210503381	E452B3A50011C31
2735	2210503382	E452B3A50011C32
2736	2210503383	E452B3A50011C33
2737	2210503384	E452B3A50011C34
2738	2210503385	E452B3A50011C35
2739	2210503386	E452B3A50011C3A
2740	2210503387	E452B3A50011C3B
2741	2210503388	E452B3A50011C3C
2742	2210503389	E452B3A50011C3D
2743	2210503390	E452B3A50011C3E
2744	2210503391	E452B3A50011C3G
2745	2210503392	E452B3A50011C3H
2746	2210503393	E452B3A50011C3K
2747	2210503394	E452B3A50011C3L
2748	2210503395	E452B3A50011C3M
2749	2210503396	E452B3A50011C41
2750	2210503397	E452B3A50011C42
2751	2210503398	E452B3A50011C43
2752	2210503399	E452B3A50011C44
2753	2210503400	E452B3A50011C45
2754	2210503401	E452B3A50011C4A
2755	2210503402	E452B3A50011C4B
2756	2210503403	E452B3A50011C4C
2757	2210503404	E452B3A50011C4D
2758	2210503405	E452B3A50011C4E
2759	2210503406	E452B3A50011C4G
2760	2210503407	E452B3A50011C4K

THIS DRAWING CONTAINS INFORMATION THAT IS PROPRIETARY TO MOLEX ELECTRONIC TECHNOLOGIES, LLC AND SHOULD NOT BE USED WITHOUT WRITTEN PERMISSION									
DIMENSION UNITS		SCALE		CURRENT REV DESC: REVISION CREATED FOR REMOVING PRE-RELEASE STAMP				 E452XXXXXXXXXX DIN FORM A EN 175301-803	
mm		NTS							
GENERAL TOLERANCES (UNLESS SPECIFIED)				EC NO: 714567		2022/07/18		PRODUCT CUSTOMER DRAWING	
				DRWN: SUGEEB		2022/07/19			
				CHK'D: GGA		2022/07/19		DOCUMENT NUMBER	
				APPR: GGA		2022/07/19			
				INITIAL REVISION:				SD-121050-001	
				DRWN: JMARSZALEK		2012/08/27			
				APPR: MDYSZEWSKA		2012/08/20		DOC TYPE	
				ANGULAR TOL				DOC PART	
				DRAFT WHERE APPLICABLE MUST REMAIN WITHIN DIMENSIONS		FIRST ANGLE PROJECTION		REVISION	
						DRAWING		PSD	
						SERIES		001	
						MATERIAL NUMBER		E1	
						CUSTOMER			
						SHEET NUMBER			
						SEE TABLE		20 OF 41	
						GENERAL MARKET			

TABLE 3 - PART LIST

Pos.	Molex PN:	Engineering No.:
2761	2210503408	E452B3A50011C4L
2762	2210503409	E452B3A50011C4M
2763	2210503414	E452B3A50011E05
2764	N/A	N/A
2765	N/A	N/A
2766	N/A	N/A
2767	N/A	N/A
2768	2210503429	E452B3A50011R05
2769	N/A	N/A
2770	N/A	N/A
2771	N/A	N/A
2772	N/A	N/A
2773	N/A	N/A
2774	N/A	N/A
2775	N/A	N/A
2776	N/A	N/A
2777	N/A	N/A
2778	N/A	N/A
2779	2210503440	E452B3A50011R21
2780	2210503441	E452B3A50011R22
2781	2210503442	E452B3A50011R23
2782	2210503443	E452B3A50011R24
2783	2210503444	E452B3A50011R25
2784	2210503445	E452B3A50011R2A
2785	2210503446	E452B3A50011R2B
2786	2210503447	E452B3A50011R2C
2787	2210503448	E452B3A50011R2D
2788	2210503449	E452B3A50011R2E
2789	2210503450	E452B3A50011R2G
2790	2210503451	E452B3A50011R2H
2791	2210503452	E452B3A50011R2K
2792	2210503453	E452B3A50011R2L
2793	2210503454	E452B3A50011R2M
2794	2210503455	E452B3A50011S01
2795	2210503456	E452B3A50011S02
2796	2210503457	E452B3A50011S03
2797	2210503458	E452B3A50011S04
2798	2210503459	E452B3A50011S05
2799	2210503460	E452B3A50011S0A
2800	2210503461	E452B3A50011S0B

Pos.	Molex PN:	Engineering No.:
2801	2210503462	E452B3A50011S0C
2802	2210503463	E452B3A50011S0D
2803	2210503464	E452B3A50011S0E
2804	2210503465	E452B3A50011S0G
2805	2210503466	E452B3A50011S0H
2806	2210503467	E452B3A50011S0K
2807	2210503468	E452B3A50011S0L
2808	2210503469	E452B3A50011S0M
2809	2210503470	E452I2N20011A11
2810	2210503471	E452I2N20011A12
2811	2210503472	E452I2N20011A13
2812	2210503473	E452I2N20011A14
2813	2210503474	E452I2N20011A15
2814	2210503475	E452I2N20011A1A
2815	2210503476	E452I2N20011A1B
2816	2210503477	E452I2N20011A1C
2817	2210503478	E452I2N20011A1D
2818	2210503479	E452I2N20011A1E
2819	2210503480	E452I2N20011A1G
2820	2210503481	E452I2N20011A1H
2821	2210503482	E452I2N20011A1K
2822	2210503483	E452I2N20011A1L
2823	2210503484	E452I2N20011A1M
2824	2210503485	E452I2N20011C31
2825	2210503486	E452I2N20011C32
2826	2210503487	E452I2N20011C33
2827	2210503488	E452I2N20011C34
2828	2210503489	E452I2N20011C35
2829	2210503490	E452I2N20011C3A
2830	2210503491	E452I2N20011C3B
2831	2210503492	E452I2N20011C3C
2832	2210503493	E452I2N20011C3D
2833	2210503494	E452I2N20011C3E
2834	2210503495	E452I2N20011C3G
2835	2210503497	E452I2N20011C3K
2836	2210503498	E452I2N20011C3L
2837	2210503499	E452I2N20011C3M
2838	2210503501	E452I2N10011000
2839	2210503502	E452I2N10011A11
2840	2210503503	E452I2N10011A12

Pos.	Molex PN:	Engineering No.:
2841	2210503504	E452I2N10011A13
2842	2210503505	E452I2N10011A14
2843	2210503506	E452I2N10011A15
2844	2210503507	E452I2N10011A1A
2845	2210503508	E452I2N10011A1B
2846	2210503509	E452I2N10011A1C
2847	2210503510	E452I2N10011A1D
2848	2210503511	E452I2N10011A1E
2849	2210503512	E452I2N10011A1G
2850	2210503513	E452I2N10011A1H
2851	2210503514	E452I2N10011A1K
2852	2210503515	E452I2N10011A1L
2853	2210503516	E452I2N10011A1M
2854	2210503517	E452I2N10011C31
2855	2210503518	E452I2N10011C32
2856	2210503519	E452I2N10011C33
2857	2210503520	E452I2N10011C34
2858	2210503521	E452I2N10011C35
2859	2210503522	E452I2N10011C3A
2860	2210503523	E452I2N10011C3B
2861	2210503524	E452I2N10011C3C
2862	2210503525	E452I2N10011C3D
2863	2210503526	E452I2N10011C3E
2864	2210503527	E452I2N10011C3G
2865	2210503528	E452I2N10011C3H
2866	2210503529	E452I2N10011C3K
2867	2210503530	E452I2N10011C3L
2868	2210503531	E452I2N10011C3M
2869	2210503532	E452I2N10011C41
2870	2210503533	E452I2N10011C43
2871	2210503534	E452I2N10011C44
2872	2210503535	E452I2N10011C45
2873	2210503536	E452I2N10011C4A
2874	2210503537	E452I2N10011C4B
2875	2210503538	E452I2N10011C4C
2876	2210503539	E452I2N10011C4D
2877	2210503540	E452I2N10011C4E
2878	2210503541	E452I2N10011C4G
2879	2210503542	E452I2N10011C4K
2880	2210503543	E452I2N10011C4L

Pos.	Molex PN:	Engineering No.:
2881	2210503544	E452I2N10011C4M
2882	2210503549	E452I2N10011E05
2883	N/A	N/A
2884	N/A	N/A
2885	N/A	N/A
2886	N/A	N/A
2887	2210503564	E452I2N10011R05
2888	N/A	N/A
2889	N/A	N/A
2890	N/A	N/A
2891	N/A	N/A
2892	N/A	N/A
2893	N/A	N/A
2894	N/A	N/A
2895	N/A	N/A
2896	N/A	N/A
2897	N/A	N/A
2898	2210503575	E452I2N10011R21
2899	2210503576	E452I2N10011R22
2900	2210503577	E452I2N10011R23
2901	2210503578	E452I2N10011R24
2902	2210503579	E452I2N10011R25
2903	2210503580	E452I2N10011R2A
2904	2210503581	E452I2N10011R2B
2905	2210503582	E452I2N10011R2C
2906	2210503583	E452I2N10011R2D
2907	2210503584	E452I2N10011R2E
2908	2210503585	E452I2N10011R2G
2909	2210503586	E452I2N10011R2H
2910	2210503587	E452I2N10011R2K
2911	2210503588	E452I2N10011R2L
2912	2210503589	E452I2N10011R2M
2913	2210503590	E452I2N10011S01
2914	2210503591	E452I2N10011S02
2915	2210503592	E452I2N10011S03
2916	2210503593	E452I2N10011S04
2917	2210503594	E452I2N10011S05
2918	2210503595	E452I2N10011S0A
2919	2210503596	E452I2N10011S0B
2920	2210503597	E452I2N10011S0C

THIS DRAWING CONTAINS INFORMATION THAT IS PROPRIETARY TO MOLEX ELECTRONIC TECHNOLOGIES, LLC AND SHOULD NOT BE USED WITHOUT WRITTEN PERMISSION									
DIMENSION UNITS		SCALE		CURRENT REV DESC: REVISION CREATED FOR REMOVING PRE-RELEASE STAMP				 E452XXXXXXXXXX DIN FORM A EN 175301-803	
mm		NTS							
GENERAL TOLERANCES (UNLESS SPECIFIED)				EC NO: 714567		2022/07/18		PRODUCT CUSTOMER DRAWING	
				DRWN: SUGEEB		2022/07/19			
				CHK'D: GGA		2022/07/19		DOCUMENT NUMBER	
				APPR: GGA		2022/07/19			
				INITIAL REVISION:				SD-121050-001	
				DRWN: JMARSZALEK		2012/08/27			
				APPR: MDYSZEWSKA		2012/08/20		DOC TYPE	
				DRAFT WHERE APPLICABLE MUST REMAIN WITHIN DIMENSIONS		FIRST ANGLE PROJECTION		DOC PART	
						DRAWING		REVISION	
						SERIES		PSD	
						MATERIAL NUMBER		001	
						CUSTOMER		E1	
						SHEET NUMBER		21 OF 41	

TABLE 3 - PART LIST

Pos.	Molex PN:	Engineering No.:
2921	2210503598	E452I2N10011S0D
2922	2210503599	E452I2N10011S0E
2923	2210503600	E452I2N10011S0G
2924	2210503601	E452I2N10011S0H
2925	2210503602	E452I2N10011S0K
2926	2210503603	E452I2N10011S0L
2927	2210503604	E452I2N10011S0M
2928	2210503605	E452I2N10K11000
2929	2210503606	E452I2N10K11A11
2930	2210503607	E452I2N10K11A12
2931	2210503608	E452I2N10K11A13
2932	2210503609	E452I2N10K11A14
2933	2210503610	E452I2N10K11A15
2934	2210503611	E452I2N10K11A1A
2935	2210503612	E452I2N10K11A1B
2936	2210503613	E452I2N10K11A1C
2937	2210503614	E452I2N10K11A1D
2938	2210503615	E452I2N10K11A1E
2939	2210503616	E452I2N10K11A1G
2940	2210503617	E452I2N10K11A1H
2941	2210503618	E452I2N10K11A1K
2942	2210503619	E452I2N10K11A1L
2943	2210503620	E452I2N10K11A1M
2944	2210503621	E452I2N10K11C31
2945	2210503622	E452I2N10K11C32
2946	2210503623	E452I2N10K11C33
2947	2210503624	E452I2N10K11C34
2948	2210503625	E452I2N10K11C35
2949	2210503626	E452I2N10K11C3A
2950	2210503627	E452I2N10K11C3B
2951	2210503628	E452I2N10K11C3C
2952	2210503629	E452I2N10K11C3D
2953	2210503630	E452I2N10K11C3E
2954	2210503631	E452I2N10K11C3G
2955	2210503632	E452I2N10K11C3H
2956	2210503633	E452I2N10K11C3K
2957	2210503634	E452I2N10K11C3L
2958	2210503635	E452I2N10K11C3M
2959	2210503636	E452I2N10K11C41
2960	2210503637	E452I2N10K11C42

Pos.	Molex PN:	Engineering No.:
2961	2210503638	E452I2N10K11C43
2962	2210503639	E452I2N10K11C44
2963	2210503640	E452I2N10K11C45
2964	2210503641	E452I2N10K11C4A
2965	2210503642	E452I2N10K11C4B
2966	2210503643	E452I2N10K11C4C
2967	2210503644	E452I2N10K11C4D
2968	2210503645	E452I2N10K11C4E
2969	2210503646	E452I2N10K11C4G
2970	2210503647	E452I2N10K11C4K
2971	2210503648	E452I2N10K11C4L
2972	2210503649	E452I2N10K11C4M
2973	2210503654	E452I2N10K11E05
2974	N/A	N/A
2975	N/A	N/A
2976	N/A	N/A
2977	N/A	N/A
2978	2210503669	E452I2N10K11R05
2979	N/A	N/A
2980	N/A	N/A
2981	N/A	N/A
2982	N/A	N/A
2983	N/A	N/A
2984	N/A	N/A
2985	N/A	N/A
2986	N/A	N/A
2987	N/A	N/A
2988	N/A	N/A
2989	2210503680	E452I2N10K11R21
2990	2210503681	E452I2N10K11R22
2991	2210503682	E452I2N10K11R23
2992	2210503683	E452I2N10K11R24
2993	2210503684	E452I2N10K11R25
2994	2210503685	E452I2N10K11R2A
2995	2210503686	E452I2N10K11R2B
2996	2210503687	E452I2N10K11R2C
2997	2210503688	E452I2N10K11R2D
2998	2210503689	E452I2N10K11R2E
2999	2210503690	E452I2N10K11R2G
3000	2210503691	E452I2N10K11R2H

Pos.	Molex PN:	Engineering No.:
3001	2210503692	E452I2N10K11R2K
3002	2210503693	E452I2N10K11R2L
3003	2210503694	E452I2N10K11R2M
3004	2210503695	E452I2N10K11S01
3005	2210503696	E452I2N10K11S02
3006	2210503697	E452I2N10K11S03
3007	2210503698	E452I2N10K11S04
3008	2210503699	E452I2N10K11S05
3009	2210503700	E452I2N10K11S0A
3010	2210503701	E452I2N10K11S0B
3011	2210503702	E452I2N10K11S0C
3012	2210503703	E452I2N10K11S0D
3013	2210503704	E452I2N10K11S0E
3014	2210503705	E452I2N10K11S0G
3015	2210503706	E452I2N10K11S0H
3016	2210503707	E452I2N10K11S0K
3017	2210503708	E452I2N10K11S0L
3018	2210503709	E452I2N10K11S0M
3019	2210503710	E452I2N15011000
3020	2210503711	E452I2N15011A11
3021	2210503712	E452I2N15011A12
3022	2210503713	E452I2N15011A13
3023	2210503714	E452I2N15011A14
3024	2210503715	E452I2N15011A15
3025	2210503716	E452I2N15011A1A
3026	2210503717	E452I2N15011A1B
3027	2210503718	E452I2N15011A1C
3028	2210503719	E452I2N15011A1D
3029	2210503720	E452I2N15011A1E
3030	2210503721	E452I2N15011A1G
3031	2210503722	E452I2N15011A1H
3032	2210503723	E452I2N15011A1K
3033	2210503724	E452I2N15011A1L
3034	2210503725	E452I2N15011A1M
3035	2210503726	E452I2N15011C31
3036	2210503727	E452I2N15011C32
3037	2210503728	E452I2N15011C33
3038	2210503729	E452I2N15011C34
3039	2210503730	E452I2N15011C35
3040	2210503731	E452I2N15011C3A

Pos.	Molex PN:	Engineering No.:
3041	2210503732	E452I2N15011C3B
3042	2210503733	E452I2N15011C3C
3043	2210503734	E452I2N15011C3D
3044	2210503735	E452I2N15011C3E
3045	2210503736	E452I2N15011C3G
3046	2210503737	E452I2N15011C3K
3047	2210503738	E452I2N15011C3L
3048	2210503739	E452I2N15011C3M
3049	2210503740	E452I2N15011C41
3050	2210503741	E452I2N15011C42
3051	2210503742	E452I2N15011C43
3052	2210503743	E452I2N15011C44
3053	2210503744	E452I2N15011C45
3054	2210503745	E452I2N15011C4A
3055	2210503746	E452I2N15011C4B
3056	2210503747	E452I2N15011C4C
3057	2210503748	E452I2N15011C4D
3058	2210503749	E452I2N15011C4E
3059	2210503750	E452I2N15011C4G
3060	2210503751	E452I2N15011C4H
3061	2210503752	E452I2N15011C4K
3062	2210503753	E452I2N15011C4L
3063	2210503754	E452I2N15011C4M
3064	2210503759	E452I2N15011E05
3065	N/A	N/A
3066	N/A	N/A
3067	N/A	N/A
3068	N/A	N/A
3069	2210503774	E452I2N15011R05
3070	N/A	N/A
3071	N/A	N/A
3072	N/A	N/A
3073	N/A	N/A
3074	N/A	N/A
3075	N/A	N/A
3076	N/A	N/A
3077	N/A	N/A
3078	N/A	N/A
3079	N/A	N/A
3080	2210503785	E452I2N15011R21

THIS DRAWING CONTAINS INFORMATION THAT IS PROPRIETARY TO MOLEX ELECTRONIC TECHNOLOGIES, LLC AND SHOULD NOT BE USED WITHOUT WRITTEN PERMISSION											
DIMENSION UNITS		SCALE		CURRENT REV DESC: REVISION CREATED FOR REMOVING PRE-RELEASE STAMP						 E452XXXXXXXXXX DIN FORM A EN 175301-803	
mm		NTS									
GENERAL TOLERANCES (UNLESS SPECIFIED)				EC NO: 714567		DRWN: SUGEEB		2022/07/18		PRODUCT CUSTOMER DRAWING DOCUMENT NUMBER: SD-121050-001 DOC TYPE: PSD DOC PART: 001 REVISION: E1	
				CHK'D: GGA		2022/07/19					
				APPR: GGA		2022/07/19					
				INITIAL REVISION:		DRWN: JMARSZALEK		2012/08/27			
				APPR: MDYSZEWSKA		2012/08/20					
DRAFT WHERE APPLICABLE MUST REMAIN WITHIN DIMENSIONS				FIRST ANGLE PROJECTION		DRAWING		SERIES		MATERIAL NUMBER	
						A3-SIZE		121050		SEE TABLE	
								GENERAL MARKET		SHEET NUMBER: 22 OF 41	

TABLE 3 - PART LIST

Pos.	Molex PN:	Engineering No.:
3241	2210503973	E452I2N30011R2M
3242	2210503974	E452I2N30011S01
3243	2210503975	E452I2N30011S02
3244	2210503976	E452I2N30011S03
3245	2210503977	E452I2N30011S04
3246	2210503978	E452I2N30011S05
3247	2210503979	E452I2N30011S0A
3248	2210503980	E452I2N30011S0B
3249	2210503981	E452I2N30011S0C
3250	2210503982	E452I2N30011S0D
3251	2210503983	E452I2N30011S0E
3252	2210503984	E452I2N30011S0G
3253	2210503985	E452I2N30011S0H
3254	2210503986	E452I2N30011S0K
3255	2210503987	E452I2N30011S0L
3256	2210503988	E452I2N30011S0M
3257	2210503989	E452I2N50011000
3258	2210503990	E452I2N50011A11
3259	2210503991	E452I2N50011A12
3260	2210503992	E452I2N50011A13
3261	2210503993	E452I2N50011A14
3262	2210503994	E452I2N50011A15
3263	2210503995	E452I2N50011A1A
3264	2210503996	E452I2N50011A1B
3265	2210503997	E452I2N50011A1C
3266	2210503998	E452I2N50011A1D
3267	2210503999	E452I2N50011A1E
3268	2210504000	E452I2N50011A1G
3269	2210504001	E452I2N50011A1H
3270	2210504002	E452I2N50011A1K
3271	2210504003	E452I2N50011A1L
3272	2210504004	E452I2N50011A1M
3273	2210504005	E452I2N50011C31
3274	2210504006	E452I2N50011C32
3275	2210504007	E452I2N50011C33
3276	2210504008	E452I2N50011C34
3277	2210504009	E452I2N50011C35
3278	2210504010	E452I2N50011C3A
3279	2210504011	E452I2N50011C3B
3280	2210504012	E452I2N50011C3C

Pos.	Molex PN:	Engineering No.:
3281	2210504013	E452I2N50011C3D
3282	2210504014	E452I2N50011C3E
3283	2210504015	E452I2N50011C3G
3284	2210504016	E452I2N50011C3K
3285	2210504017	E452I2N50011C3L
3286	2210504018	E452I2N50011C3M
3287	2210504019	E452I2N50011C41
3288	2210504020	E452I2N50011C43
3289	2210504021	E452I2N50011C45
3290	2210504022	E452I2N50011C4A
3291	2210504023	E452I2N50011C4B
3292	2210504024	E452I2N50011C4C
3293	2210504025	E452I2N50011C4D
3294	2210504026	E452I2N50011C4E
3295	2210504027	E452I2N50011C4G
3296	2210504028	E452I2N50011C4K
3297	2210504029	E452I2N50011C4L
3298	2210504030	E452I2N50011C4M
3299	2210504035	E452I2N50011E05
3300	N/A	N/A
3301	N/A	N/A
3302	N/A	N/A
3303	N/A	N/A
3304	2210504050	E452I2N50011R05
3305	N/A	N/A
3306	N/A	N/A
3307	N/A	N/A
3308	N/A	N/A
3309	N/A	N/A
3310	N/A	N/A
3311	N/A	N/A
3312	N/A	N/A
3313	N/A	N/A
3314	N/A	N/A
3315	2210504061	E452I2N50011R21
3316	2210504062	E452I2N50011R22
3317	2210504063	E452I2N50011R23
3318	2210504064	E452I2N50011R24
3319	2210504065	E452I2N50011R25
3320	2210504066	E452I2N50011R2A

Pos.	Molex PN:	Engineering No.:
3321	2210504067	E452I2N50011R2B
3322	2210504068	E452I2N50011R2C
3323	2210504069	E452I2N50011R2D
3324	2210504070	E452I2N50011R2E
3325	2210504071	E452I2N50011R2G
3326	2210504072	E452I2N50011R2H
3327	2210504073	E452I2N50011R2K
3328	2210504074	E452I2N50011R2L
3329	2210504075	E452I2N50011R2M
3330	2210504076	E452I2N50011S01
3331	2210504077	E452I2N50011S02
3332	2210504078	E452I2N50011S03
3333	2210504079	E452I2N50011S04
3334	2210504080	E452I2N50011S05
3335	2210504081	E452I2N50011S0A
3336	2210504082	E452I2N50011S0B
3337	2210504083	E452I2N50011S0C
3338	2210504084	E452I2N50011S0D
3339	2210504085	E452I2N50011S0E
3340	2210504086	E452I2N50011S0G
3341	2210504087	E452I2N50011S0H
3342	2210504088	E452I2N50011S0K
3343	2210504089	E452I2N50011S0L
3344	2210504090	E452I2N50011S0M
3345	2210504091	E452I4N10011000
3346	2210504092	E452I4N10011A11
3347	2210504093	E452I4N10011A12
3348	2210504094	E452I4N10011A13
3349	2210504095	E452I4N10011A14
3350	2210504096	E452I4N10011A15
3351	2210504097	E452I4N10011A1A
3352	2210504098	E452I4N10011A1B
3353	2210504099	E452I4N10011A1C
3354	2210504100	E452I4N10011A1D
3355	2210504101	E452I4N10011A1E
3356	2210504102	E452I4N10011A1G
3357	2210504103	E452I4N10011A1H
3358	2210504104	E452I4N10011A1K
3359	2210504105	E452I4N10011A1L
3360	2210504106	E452I4N10011A1M

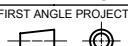
Pos.	Molex PN:	Engineering No.:
3361	2210504107	E452I4N10011C31
3362	2210504108	E452I4N10011C32
3363	2210504109	E452I4N10011C33
3364	2210504110	E452I4N10011C34
3365	2210504111	E452I4N10011C35
3366	2210504112	E452I4N10011C3A
3367	2210504113	E452I4N10011C3B
3368	2210504114	E452I4N10011C3C
3369	2210504115	E452I4N10011C3D
3370	2210504116	E452I4N10011C3E
3371	2210504117	E452I4N10011C3G
3372	2210504118	E452I4N10011C3H
3373	2210504119	E452I4N10011C3K
3374	2210504120	E452I4N10011C3L
3375	2210504121	E452I4N10011C3M
3376	2210504122	E452I4N10011C41
3377	2210504123	E452I4N10011C43
3378	2210504124	E452I4N10011C44
3379	2210504125	E452I4N10011C45
3380	2210504126	E452I4N10011C4A
3381	2210504127	E452I4N10011C4B
3382	2210504128	E452I4N10011C4C
3383	2210504129	E452I4N10011C4D
3384	2210504130	E452I4N10011C4E
3385	2210504131	E452I4N10011C4G
3386	2210504132	E452I4N10011C4K
3387	2210504133	E452I4N10011C4L
3388	2210504134	E452I4N10011C4M
3389	2210504139	E452I4N10011E05
3390	N/A	N/A
3391	N/A	N/A
3392	N/A	N/A
3393	N/A	N/A
3394	2210504154	E452I4N10011R05
3395	N/A	N/A
3396	N/A	N/A
3397	N/A	N/A
3398	N/A	N/A
3399	N/A	N/A
3400	N/A	N/A

THIS DRAWING CONTAINS INFORMATION THAT IS PROPRIETARY TO MOLEX ELECTRONIC TECHNOLOGIES, LLC AND SHOULD NOT BE USED WITHOUT WRITTEN PERMISSION									
DIMENSION UNITS		SCALE		CURRENT REV DESC: REVISION CREATED FOR REMOVING PRE-RELEASE STAMP				 E452XXXXXXXXXX DIN FORM A EN 175301-803	
mm		NTS							
GENERAL TOLERANCES (UNLESS SPECIFIED)				EC NO: 714567		2022/07/18		PRODUCT CUSTOMER DRAWING	
				DRWN: SUGEEB		2022/07/19			
				CHK'D: GGA		2022/07/19		DOCUMENT NUMBER SD-121050-001	
				APPR: GGA		2022/07/19			
				INITIAL REVISION:		2012/08/27		DOC TYPE PSD	
				DRWN: JMARSZALEK		2012/08/27			
				APPR: MDYSZEWSKA		2012/08/20		DOC PART 001	
				ANGULAR TOL				REVISION E1	
DRAFT WHERE APPLICABLE MUST REMAIN WITHIN DIMENSIONS				FIRST ANGLE PROJECTION		DRAWING		SHEET NUMBER	
						A3-SIZE		24 OF 41	
				SERIES		121050		MATERIAL NUMBER	
								CUSTOMER	
								GENERAL MARKET	

TABLE 3 - PART LIST

Pos.	Molex PN:	Engineering No.:
3561	2210504335	E452I4N15011C4C
3562	2210504336	E452I4N15011C4D
3563	2210504337	E452I4N15011C4E
3564	2210504338	E452I4N15011C4G
3565	2210504339	E452I4N15011C4K
3566	2210504340	E452I4N15011C4L
3567	2210504341	E452I4N15011C4M
3568	2210504346	E452I4N15011E05
3569	N/A	N/A
3570	N/A	N/A
3571	N/A	N/A
3572	N/A	N/A
3573	2210504361	E452I4N15011R05
3574	N/A	N/A
3575	N/A	N/A
3576	N/A	N/A
3577	N/A	N/A
3578	N/A	N/A
3579	N/A	N/A
3580	N/A	N/A
3581	N/A	N/A
3582	N/A	N/A
3583	N/A	N/A
3584	2210504372	E452I4N15011R21
3585	2210504373	E452I4N15011R23
3586	2210504374	E452I4N15011R24
3587	2210504375	E452I4N15011R25
3588	2210504376	E452I4N15011R2A
3589	2210504377	E452I4N15011R2B
3590	2210504378	E452I4N15011R2C
3591	2210504379	E452I4N15011R2D
3592	2210504380	E452I4N15011R2E
3593	2210504381	E452I4N15011R2G
3594	2210504382	E452I4N15011R2H
3595	2210504383	E452I4N15011R2K
3596	2210504384	E452I4N15011R2L
3597	2210504385	E452I4N15011R2M
3598	2210504386	E452I4N15011S01
3599	2210504387	E452I4N15011S02
3600	2210504388	E452I4N15011S03

Pos.	Molex PN:	Engineering No.:
3601	2210504389	E452I4N15011S04
3602	2210504390	E452I4N15011S05
3603	2210504391	E452I4N15011S0A
3604	2210504392	E452I4N15011S0B
3605	2210504393	E452I4N15011S0C
3606	2210504394	E452I4N15011S0D
3607	2210504395	E452I4N15011S0E
3608	2210504396	E452I4N15011S0G
3609	2210504397	E452I4N15011S0H
3610	2210504398	E452I4N15011S0K
3611	2210504399	E452I4N15011S0L
3612	2210504400	E452I4N15011S0M
3613	2210504401	E452I4N20011000
3614	2210504402	E452I4N20011A11
3615	2210504403	E452I4N20011A12
3616	2210504404	E452I4N20011A13
3617	2210504405	E452I4N20011A14
3618	2210504406	E452I4N20011A15
3619	2210504407	E452I4N20011A1A
3620	2210504408	E452I4N20011A1B
3621	2210504409	E452I4N20011A1C
3622	2210504410	E452I4N20011A1D
3623	2210504411	E452I4N20011A1E
3624	2210504412	E452I4N20011A1G
3625	2210504413	E452I4N20011A1H
3626	2210504414	E452I4N20011A1K
3627	2210504415	E452I4N20011A1L
3628	2210504416	E452I4N20011A1M
3629	2210504417	E452I4N20011C31
3630	2210504418	E452I4N20011C32
3631	2210504419	E452I4N20011C33
3632	2210504420	E452I4N20011C34
3633	2210504421	E452I4N20011C35
3634	2210504422	E452I4N20011C3A
3635	2210504423	E452I4N20011C3C
3636	2210504424	E452I4N20011C3D
3637	2210504425	E452I4N20011C3E
3638	2210504426	E452I4N20011C3G
3639	2210504427	E452I4N20011C3K
3640	2210504428	E452I4N20011C3L

Pos.	Molex PN:	Engineering No.:
3641	2210504429	E452I4N20011C3M
3642	2210504430	E452I4N20011C41
3643	2210504431	E452I4N20011C42
3644	2210504432	E452I4N20011C43
3645	2210504433	E452I4N20011C44
3646	2210504434	E452I4N20011C45
3647	2210504435	E452I4N20011C4A
3648	2210504436	E452I4N20011C4B
3649	2210504437	E452I4N20011C4C
3650	2210504438	E452I4N20011C4D
3651	2210504439	E452I4N20011C4E
3652	2210504440	E452I4N20011C4G
3653	2210504441	E452I4N20011C4K
3654	2210504442	E452I4N20011C4L
3655	2210504443	E452I4N20011C4M
3656	2210504448	E452I4N20011E05
3657	N/A	N/A
3658	N/A	N/A
3659	N/A	N/A
3660	N/A	N/A
3661	2210504463	E452I4N20011R05
3662	N/A	N/A
3663	N/A	N/A
3664	N/A	N/A
3665	N/A	N/A
3666	N/A	N/A
3667	N/A	N/A
3668	N/A	N/A
3669	N/A	N/A
3670	N/A	N/A
3671	N/A	N/A
3672	2210504474	E452I4N20011R21
3673	2210504475	E452I4N20011R22
3674	2210504476	E452I4N20011R23
3675	2210504477	E452I4N20011R24
3676	2210504478	E452I4N20011R25
3677	2210504479	E452I4N20011R2A
3678	2210504480	E452I4N20011R2B
3679	2210504481	E452I4N20011R2C
3680	2210504482	E452I4N20011R2D

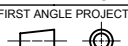
Pos.	Molex PN:	Engineering No.:
3681	2210504483	E452I4N20011R2E
3682	2210504484	E452I4N20011R2G
3683	2210504485	E452I4N20011R2H
3684	2210504486	E452I4N20011R2K
3685	2210504487	E452I4N20011R2L
3686	2210504488	E452I4N20011R2M
3687	2210504489	E452I4N20011S01
3688	2210504490	E452I4N20011S02
3689	2210504491	E452I4N20011S03
3690	2210504492	E452I4N20011S04
3691	2210504493	E452I4N20011S05
3692	2210504494	E452I4N20011S0A
3693	2210504495	E452I4N20011S0B
3694	2210504496	E452I4N20011S0C
3695	2210504497	E452I4N20011S0D
3696	2210504498	E452I4N20011S0E
3697	2210504499	E452I4N20011S0G
3698	2210504500	E452I4N20011S0H
3699	2210504501	E452I4N20011S0K
3700	2210504502	E452I4N20011S0L
3701	2210504503	E452I4N20011S0M
3702	2210504504	E452I4N30011000
3703	2210504505	E452I4N30011A11
3704	2210504506	E452I4N30011A12
3705	2210504507	E452I4N30011A13
3706	2210504508	E452I4N30011A14
3707	2210504509	E452I4N30011A15
3708	2210504510	E452I4N30011A1A
3709	2210504511	E452I4N30011A1B
3710	2210504512	E452I4N30011A1C
3711	2210504513	E452I4N30011A1D
3712	2210504514	E452I4N30011A1E
3713	2210504515	E452I4N30011A1K
3714	2210504516	E452I4N30011A1L
3715	2210504517	E452I4N30011A1M
3716	2210504518	E452I4N30011C32
3717	2210504519	E452I4N30011C33
3718	2210504520	E452I4N30011C34
3719	2210504521	E452I4N30011C35
3720	2210504522	E452I4N30011C3A

THIS DRAWING CONTAINS INFORMATION THAT IS PROPRIETARY TO MOLEX ELECTRONIC TECHNOLOGIES, LLC AND SHOULD NOT BE USED WITHOUT WRITTEN PERMISSION									
DIMENSION UNITS		SCALE		CURRENT REV DESC: REVISION CREATED FOR REMOVING PRE-RELEASE STAMP				 E452XXXXXXXXXX DIN FORM A EN 175301-803	
mm		NTS							
GENERAL TOLERANCES (UNLESS SPECIFIED)				EC NO: 714567		2022/07/18		PRODUCT CUSTOMER DRAWING	
				DRWN: SUGEEB		2022/07/19			
				CHK'D: GGA		2022/07/19		DOCUMENT NUMBER	
				APPR: GGA		2022/07/19			
				INITIAL REVISION:				SD-121050-001	
				DRWN: JMARSZALEK		2012/08/27			
				APPR: MDYSZEWSKA		2012/08/20		DOC TYPE DOC PART REVISION	
				ANGULAR TOL ± °				PSD 001 E1	
DRAFT WHERE APPLICABLE MUST REMAIN WITHIN DIMENSIONS				FIRST ANGLE PROJECTION		DRAWING		SHEET NUMBER	
						A3-SIZE		26 OF 41	
				SERIES		MATERIAL NUMBER		CUSTOMER	
				121050		SEE TABLE		GENERAL MARKET	

TABLE 3 - PART LIST

Pos.	Molex PN:	Engineering No.:
3721	2210504523	E452I4N30011C3B
3722	2210504524	E452I4N30011C3C
3723	2210504525	E452I4N30011C3D
3724	2210504526	E452I4N30011C3E
3725	2210504527	E452I4N30011C3G
3726	2210504528	E452I4N30011C3K
3727	2210504529	E452I4N30011C3L
3728	2210504530	E452I4N30011C3M
3729	2210504531	E452I4N30011C43
3730	2210504532	E452I4N30011C45
3731	2210504533	E452I4N30011C4A
3732	2210504534	E452I4N30011C4B
3733	2210504535	E452I4N30011C4C
3734	2210504536	E452I4N30011C4D
3735	2210504537	E452I4N30011C4E
3736	2210504538	E452I4N30011C4G
3737	2210504539	E452I4N30011C4K
3738	2210504544	E452I4N30011E05
3739	2210504559	E452I4N30011R05
3740	2210504570	E452I4N30011R21
3741	2210504571	E452I4N30011R22
3742	2210504572	E452I4N30011R23
3743	2210504573	E452I4N30011R24
3744	2210504574	E452I4N30011R25
3745	2210504575	E452I4N30011R2A
3746	2210504576	E452I4N30011R2B
3747	2210504577	E452I4N30011R2C
3748	2210504578	E452I4N30011R2D
3749	2210504579	E452I4N30011R2E
3750	2210504580	E452I4N30011R2G
3751	2210504581	E452I4N30011R2K
3752	2210504582	E452I4N30011S01
3753	2210504583	E452I4N30011S02
3754	2210504584	E452I4N30011S03
3755	2210504585	E452I4N30011S04
3756	2210504586	E452I4N30011S05
3757	2210504587	E452I4N30011S0A
3758	2210504588	E452I4N30011S0B
3759	2210504589	E452I4N30011S0C
3760	2210504590	E452I4N30011S0D

Pos.	Molex PN:	Engineering No.:
3761	2210504591	E452I4N30011S0E
3762	2210504592	E452I4N30011S0G
3763	2210504593	E452I4N30011S0K
3764	2210504594	E452I4N30011S0L
3765	2210504595	E452I4N30011S0M
3766	2210504596	E452I4N50011000
3767	2210504597	E452I4N50011A11
3768	2210504598	E452I4N50011A12
3769	2210504599	E452I4N50011A13
3770	2210504600	E452I4N50011A14
3771	2210504601	E452I4N50011A15
3772	2210504602	E452I4N50011A1A
3773	2210504603	E452I4N50011A1B
3774	2210504604	E452I4N50011A1C
3775	2210504605	E452I4N50011A1D
3776	2210504606	E452I4N50011A1E
3777	2210504607	E452I4N50011A1G
3778	2210504608	E452I4N50011A1H
3779	2210504609	E452I4N50011A1K
3780	2210504610	E452I4N50011A1L
3781	2210504611	E452I4N50011A1M
3782	2210504612	E452I4N50011C31
3783	2210504613	E452I4N50011C32
3784	2210504614	E452I4N50011C33
3785	2210504615	E452I4N50011C34
3786	2210504616	E452I4N50011C35
3787	2210504617	E452I4N50011C3A
3788	2210504618	E452I4N50011C3C
3789	2210504619	E452I4N50011C3D
3790	2210504620	E452I4N50011C3E
3791	2210504621	E452I4N50011C3G
3792	2210504622	E452I4N50011C3K
3793	2210504623	E452I4N50011C3L
3794	2210504624	E452I4N50011C3M
3795	2210504625	E452I4N50011C41
3796	2210504626	E452I4N50011C43
3797	2210504627	E452I4N50011C44
3798	2210504628	E452I4N50011C45
3799	2210504629	E452I4N50011C4A
3800	2210504630	E452I4N50011C4B

Pos.	Molex PN:	Engineering No.:
3801	2210504631	E452I4N50011C4C
3802	2210504632	E452I4N50011C4D
3803	2210504633	E452I4N50011C4E
3804	2210504634	E452I4N50011C4G
3805	2210504635	E452I4N50011C4K
3806	2210504640	E452I4N50011E05
3807	2210504655	E452I4N50011R05
3808	2210504666	E452I4N50011R21
3809	2210504667	E452I4N50011R22
3810	2210504668	E452I4N50011R23
3811	2210504669	E452I4N50011R24
3812	2210504670	E452I4N50011R25
3813	2210504671	E452I4N50011R2A
3814	2210504672	E452I4N50011R2B
3815	2210504673	E452I4N50011R2C
3816	2210504674	E452I4N50011R2D
3817	2210504675	E452I4N50011R2E
3818	2210504676	E452I4N50011R2G
3819	2210504677	E452I4N50011R2H
3820	2210504678	E452I4N50011R2K
3821	2210504679	E452I4N50011S01
3822	2210504680	E452I4N50011S03
3823	2210504681	E452I4N50011S04
3824	2210504682	E452I4N50011S05
3825	2210504683	E452I4N50011S0A
3826	2210504684	E452I4N50011S0B
3827	2210504685	E452I4N50011S0C
3828	2210504686	E452I4N50011S0D
3829	2210504687	E452I4N50011S0E
3830	2210504688	E452I4N50011S0G
3831	2210504689	E452I4N50011S0K
3832	2210504690	E452I4N50011S0L
3833	2210504691	E452I4N50011S0M
3834	2210504692	E452N2N10011000
3835	2210504693	E452N2N10011A11
3836	2210504694	E452N2N10011A13
3837	2210504695	E452N2N10011A14
3838	2210504696	E452N2N10011A15
3839	2210504697	E452N2N10011A1A
3840	2210504698	E452N2N10011A1B

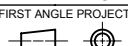
Pos.	Molex PN:	Engineering No.:
3841	2210504699	E452N2N10011A1C
3842	2210504700	E452N2N10011A1D
3843	2210504701	E452N2N10011A1E
3844	2210504702	E452N2N10011A1G
3845	2210504703	E452N2N10011A1H
3846	2210504704	E452N2N10011A1K
3847	2210504705	E452N2N10011A1L
3848	2210504706	E452N2N10011A1M
3849	2210504707	E452N2N10011C31
3850	2210504708	E452N2N10011C32
3851	2210504709	E452N2N10011C33
3852	2210504710	E452N2N10011C34
3853	2210504711	E452N2N10011C35
3854	2210504712	E452N2N10011C3A
3855	2210504713	E452N2N10011C3B
3856	2210504714	E452N2N10011C3C
3857	2210504715	E452N2N10011C3D
3858	2210504716	E452N2N10011C3E
3859	2210504717	E452N2N10011C3G
3860	2210504718	E452N2N10011C3H
3861	2210504719	E452N2N10011C3K
3862	2210504720	E452N2N10011C3L
3863	2210504721	E452N2N10011C3M
3864	2210504722	E452N2N10011C41
3865	2210504723	E452N2N10011C42
3866	2210504724	E452N2N10011C43
3867	2210504725	E452N2N10011C44
3868	2210504726	E452N2N10011C45
3869	2210504727	E452N2N10011C4A
3870	2210504728	E452N2N10011C4B
3871	2210504729	E452N2N10011C4C
3872	2210504730	E452N2N10011C4E
3873	2210504731	E452N2N10011C4G
3874	2210504732	E452N2N10011C4H
3875	2210504733	E452N2N10011C4K
3876	2210504734	E452N2N10011C4L
3877	2210504735	E452N2N10011C4M
3878	2210504740	E452N2N10011E05
3879	2210504755	E452N2N10011R05
3880	2210504766	E452N2N10011R21

THIS DRAWING CONTAINS INFORMATION THAT IS PROPRIETARY TO MOLEX ELECTRONIC TECHNOLOGIES, LLC AND SHOULD NOT BE USED WITHOUT WRITTEN PERMISSION									
DIMENSION UNITS		SCALE		CURRENT REV DESC: REVISION CREATED FOR REMOVING PRE-RELEASE STAMP				 E452XXXXXXXXXX DIN FORM A EN 175301-803	
mm		NTS							
GENERAL TOLERANCES (UNLESS SPECIFIED)				EC NO: 714567		2022/07/18		PRODUCT CUSTOMER DRAWING DOCUMENT NUMBER: SD-121050-001 DOC TYPE: PSD DOC PART: 001 REVISION: E1	
				DRWN: SUGEEB		2022/07/19			
				CHK'D: GGA		2022/07/19			
				APPR: GGA					
				INITIAL REVISION:					
				DRWN: JMARSZALEK		2012/08/27			
				APPR: MDYSZEWSKA		2012/08/20			
DRAFT WHERE APPLICABLE MUST REMAIN WITHIN DIMENSIONS				FIRST ANGLE PROJECTION		DRAWING		SERIES	
						A3-SIZE		121050	
				MATERIAL NUMBER		CUSTOMER		SHEET NUMBER	
				SEE TABLE		GENERAL MARKET		27 OF 41	

TABLE 3 - PART LIST

Pos.	Molex PN:	Engineering No.:
3881	2210504767	E452N2N10011R22
3882	2210504768	E452N2N10011R23
3883	2210504769	E452N2N10011R25
3884	2210504770	E452N2N10011R2A
3885	2210504771	E452N2N10011R2B
3886	2210504772	E452N2N10011R2C
3887	2210504773	E452N2N10011R2D
3888	2210504774	E452N2N10011R2E
3889	2210504775	E452N2N10011R2G
3890	2210504776	E452N2N10011R2K
3891	2210504777	E452N2N10011R2L
3892	2210504778	E452N2N10011R2M
3893	2210504779	E452N2N10011S01
3894	2210504780	E452N2N10011S02
3895	2210504781	E452N2N10011S03
3896	2210504782	E452N2N10011S04
3897	2210504783	E452N2N10011S05
3898	2210504784	E452N2N10011S0A
3899	2210504785	E452N2N10011S0B
3900	2210504786	E452N2N10011S0C
3901	2210504787	E452N2N10011S0D
3902	2210504788	E452N2N10011S0E
3903	2210504789	E452N2N10011S0G
3904	2210504790	E452N2N10011S0H
3905	2210504791	E452N2N10011S0K
3906	2210504792	E452N2N10011S0L
3907	2210504793	E452N2N10011S0M
3908	2210504794	E452N2N10K11000
3909	2210504795	E452N2N10K11A11
3910	2210504796	E452N2N10K11A12
3911	2210504797	E452N2N10K11A13
3912	2210504798	E452N2N10K11A14
3913	2210504799	E452N2N10K11A15
3914	2210504800	E452N2N10K11A1A
3915	2210504801	E452N2N10K11A1B
3916	2210504802	E452N2N10K11A1C
3917	2210504803	E452N2N10K11A1D
3918	2210504804	E452N2N10K11A1E
3919	2210504805	E452N2N10K11A1G
3920	2210504806	E452N2N10K11A1H

Pos.	Molex PN:	Engineering No.:
3921	2210504807	E452N2N10K11A1K
3922	2210504808	E452N2N10K11A1L
3923	2210504809	E452N2N10K11A1M
3924	2210504810	E452N2N10K11C31
3925	2210504811	E452N2N10K11C32
3926	2210504812	E452N2N10K11C33
3927	2210504813	E452N2N10K11C34
3928	2210504814	E452N2N10K11C35
3929	2210504815	E452N2N10K11C3A
3930	2210504816	E452N2N10K11C3B
3931	2210504817	E452N2N10K11C3C
3932	2210504818	E452N2N10K11C3D
3933	2210504819	E452N2N10K11C3E
3934	2210504820	E452N2N10K11C3G
3935	2210504821	E452N2N10K11C3H
3936	2210504822	E452N2N10K11C3K
3937	2210504823	E452N2N10K11C3L
3938	2210504824	E452N2N10K11C3M
3939	2210504825	E452N2N10K11C41
3940	2210504826	E452N2N10K11C43
3941	2210504827	E452N2N10K11C44
3942	2210504828	E452N2N10K11C45
3943	2210504829	E452N2N10K11C4A
3944	2210504830	E452N2N10K11C4B
3945	2210504831	E452N2N10K11C4C
3946	2210504832	E452N2N10K11C4D
3947	2210504833	E452N2N10K11C4E
3948	2210504834	E452N2N10K11C4G
3949	2210504835	E452N2N10K11C4H
3950	2210504836	E452N2N10K11C4K
3951	2210504837	E452N2N10K11C4L
3952	2210504838	E452N2N10K11C4M
3953	2210504843	E452N2N10K11E05
3954	2210504858	E452N2N10K11R05
3955	2210504869	E452N2N10K11R21
3956	2210504870	E452N2N10K11R22
3957	2210504871	E452N2N10K11R23
3958	2210504872	E452N2N10K11R24
3959	2210504873	E452N2N10K11R25
3960	2210504874	E452N2N10K11R2A

Pos.	Molex PN:	Engineering No.:
3961	2210504875	E452N2N10K11R2B
3962	2210504876	E452N2N10K11R2C
3963	2210504877	E452N2N10K11R2D
3964	2210504878	E452N2N10K11R2E
3965	2210504879	E452N2N10K11R2G
3966	2210504880	E452N2N10K11R2H
3967	2210504881	E452N2N10K11R2K
3968	2210504882	E452N2N10K11R2L
3969	2210504883	E452N2N10K11R2M
3970	2210504884	E452N2N10K11S01
3971	2210504885	E452N2N10K11S02
3972	2210504886	E452N2N10K11S03
3973	2210504887	E452N2N10K11S04
3974	2210504888	E452N2N10K11S05
3975	2210504889	E452N2N10K11S0A
3976	2210504890	E452N2N10K11S0B
3977	2210504891	E452N2N10K11S0C
3978	2210504892	E452N2N10K11S0D
3979	2210504893	E452N2N10K11S0E
3980	2210504894	E452N2N10K11S0G
3981	2210504895	E452N2N10K11S0H
3982	2210504896	E452N2N10K11S0K
3983	2210504897	E452N2N10K11S0L
3984	2210504898	E452N2N10K11S0M
3985	2210504899	E452N2N15011000
3986	2210504900	E452N2N15011A11
3987	2210504901	E452N2N15011A12
3988	2210504902	E452N2N15011A13
3989	2210504903	E452N2N15011A14
3990	2210504904	E452N2N15011A15
3991	2210504905	E452N2N15011A1A
3992	2210504906	E452N2N15011A1B
3993	2210504907	E452N2N15011A1C
3994	2210504908	E452N2N15011A1D
3995	2210504909	E452N2N15011A1E
3996	2210504910	E452N2N15011A1G
3997	2210504911	E452N2N15011A1H
3998	2210504912	E452N2N15011A1K
3999	2210504913	E452N2N15011A1L
4000	2210504914	E452N2N15011A1M

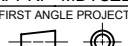
Pos.	Molex PN:	Engineering No.:
4001	2210504915	E452N2N15011C31
4002	2210504916	E452N2N15011C32
4003	2210504917	E452N2N15011C33
4004	2210504918	E452N2N15011C34
4005	2210504919	E452N2N15011C35
4006	2210504920	E452N2N15011C3A
4007	2210504921	E452N2N15011C3B
4008	2210504922	E452N2N15011C3C
4009	2210504923	E452N2N15011C3D
4010	2210504924	E452N2N15011C3E
4011	2210504925	E452N2N15011C3G
4012	2210504926	E452N2N15011C3H
4013	2210504927	E452N2N15011C3K
4014	2210504928	E452N2N15011C3L
4015	2210504929	E452N2N15011C3M
4016	2210504930	E452N2N15011C41
4017	2210504931	E452N2N15011C43
4018	2210504932	E452N2N15011C44
4019	2210504933	E452N2N15011C45
4020	2210504934	E452N2N15011C4A
4021	2210504935	E452N2N15011C4C
4022	2210504936	E452N2N15011C4D
4023	2210504937	E452N2N15011C4E
4024	2210504938	E452N2N15011C4G
4025	2210504939	E452N2N15011C4H
4026	2210504940	E452N2N15011C4K
4027	2210504941	E452N2N15011C4L
4028	2210504942	E452N2N15011C4M
4029	2210504961	E452N2N15011R05
4030	2210504972	E452N2N15011R21
4031	2210504973	E452N2N15011R22
4032	2210504974	E452N2N15011R23
4033	2210504975	E452N2N15011R24
4034	2210504976	E452N2N15011R25
4035	2210504977	E452N2N15011R2A
4036	2210504978	E452N2N15011R2B
4037	2210504979	E452N2N15011R2C
4038	2210504980	E452N2N15011R2D
4039	2210504981	E452N2N15011R2E
4040	2210504982	E452N2N15011R2G

THIS DRAWING CONTAINS INFORMATION THAT IS PROPRIETARY TO MOLEX ELECTRONIC TECHNOLOGIES, LLC AND SHOULD NOT BE USED WITHOUT WRITTEN PERMISSION									
DIMENSION UNITS		SCALE		CURRENT REV DESC: REVISION CREATED FOR REMOVING PRE-RELEASE STAMP				 E452XXXXXXXXXX DIN FORM A EN 175301-803	
mm		NTS							
GENERAL TOLERANCES (UNLESS SPECIFIED)				EC NO: 714567		2022/07/18		PRODUCT CUSTOMER DRAWING DOCUMENT NUMBER: SD-121050-001 DOC TYPE: PSD DOC PART: 001 REVISION: E1	
				DRWN: SUGEEB		2022/07/19			
				CHK'D: GGA		2022/07/19		MATERIAL NUMBER: SEE TABLE CUSTOMER: GENERAL MARKET SHEET NUMBER: 28 OF 41	
				APPR: GGA					
				INITIAL REVISION:					
				DRWN: JMARSZALEK		2012/08/27			
				APPR: MDYSZEWSKA		2012/08/20			
DRAFT WHERE APPLICABLE MUST REMAIN WITHIN DIMENSIONS				FIRST ANGLE PROJECTION		DRAWING		SERIES	
						A3-SIZE		121050	

TABLE 3 - PART LIST

Pos.	Molex PN:	Engineering No.:
4161	2210505131	E452N2N30011C4D
4162	2210505132	E452N2N30011C4E
4163	2210505133	E452N2N30011C4G
4164	2210505134	E452N2N30011C4H
4165	2210505135	E452N2N30011C4K
4166	2210505136	E452N2N30011C4L
4167	2210505141	E452N2N30011E05
4168	2210505166	E452N2N30011R21
4169	2210505167	E452N2N30011R22
4170	2210505168	E452N2N30011R23
4171	2210505169	E452N2N30011R24
4172	2210505170	E452N2N30011R25
4173	2210505171	E452N2N30011R2A
4174	2210505172	E452N2N30011R2C
4175	2210505173	E452N2N30011R2D
4176	2210505174	E452N2N30011R2E
4177	2210505175	E452N2N30011R2G
4178	2210505176	E452N2N30011R2H
4179	2210505177	E452N2N30011R2K
4180	2210505178	E452N2N30011R2L
4181	2210505179	E452N2N30011S01
4182	2210505180	E452N2N30011S02
4183	2210505181	E452N2N30011S03
4184	2210505182	E452N2N30011S04
4185	2210505183	E452N2N30011S05
4186	2210505184	E452N2N30011S0A
4187	2210505185	E452N2N30011S0B
4188	2210505186	E452N2N30011S0C
4189	2210505187	E452N2N30011S0D
4190	2210505188	E452N2N30011S0E
4191	2210505189	E452N2N30011S0G
4192	2210505190	E452N2N30011S0H
4193	2210505191	E452N2N30011S0K
4194	2210505192	E452N2N30011S0L
4195	2210505193	E452N2N30011S0M
4196	2210505194	E452N2N50011000
4197	2210505195	E452N2N50011A11
4198	2210505196	E452N2N50011A12
4199	2210505197	E452N2N50011A13
4200	2210505198	E452N2N50011A14

Pos.	Molex PN:	Engineering No.:
4201	2210505199	E452N2N50011A15
4202	2210505200	E452N2N50011A1A
4203	2210505201	E452N2N50011A1B
4204	2210505202	E452N2N50011A1C
4205	2210505203	E452N2N50011A1D
4206	2210505204	E452N2N50011A1E
4207	2210505205	E452N2N50011A1G
4208	2210505206	E452N2N50011A1H
4209	2210505207	E452N2N50011A1K
4210	2210505208	E452N2N50011A1L
4211	2210505209	E452N2N50011A1M
4212	2210505210	E452N2N50011C31
4213	2210505211	E452N2N50011C32
4214	2210505212	E452N2N50011C33
4215	2210505213	E452N2N50011C34
4216	2210505214	E452N2N50011C35
4217	2210505215	E452N2N50011C3A
4218	2210505216	E452N2N50011C3B
4219	2210505217	E452N2N50011C3C
4220	2210505218	E452N2N50011C3D
4221	2210505219	E452N2N50011C3E
4222	2210505220	E452N2N50011C3G
4223	2210505221	E452N2N50011C3H
4224	2210505222	E452N2N50011C3K
4225	2210505223	E452N2N50011C3L
4226	2210505224	E452N2N50011C3M
4227	2210505225	E452N2N50011C41
4228	2210505226	E452N2N50011C42
4229	2210505227	E452N2N50011C43
4230	2210505228	E452N2N50011C44
4231	2210505229	E452N2N50011C45
4232	2210505230	E452N2N50011C4A
4233	2210505231	E452N2N50011C4B
4234	2210505232	E452N2N50011C4C
4235	2210505233	E452N2N50011C4D
4236	2210505234	E452N2N50011C4E
4237	2210505235	E452N2N50011C4G
4238	2210505236	E452N2N50011C4K
4239	2210505237	E452N2N50011C4L
4240	2210505238	E452N2N50011C4M

Pos.	Molex PN:	Engineering No.:
4241	2210505243	E452N2N50011E05
4242	2210505244	E452N2N50011E0A
4243	2210505245	E452N2N50011E0B
4244	2210505246	E452N2N50011E0C
4245	2210505247	E452N2N50011E0D
4246	2210505248	E452N2N50011E0E
4247	2210505249	E452N2N50011E0G
4248	2210505250	E452N2N50011E0H
4249	2210505251	E452N2N50011E0K
4250	2210505252	E452N2N50011E0L
4251	2210505253	E452N2N50011E0M
4252	2210505258	E452N2N50011R05
4253	2210505269	E452N2N50011R21
4254	2210505270	E452N2N50011R22
4255	2210505271	E452N2N50011R23
4256	2210505272	E452N2N50011R24
4257	2210505273	E452N2N50011R25
4258	2210505274	E452N2N50011R2A
4259	2210505275	E452N2N50011R2B
4260	2210505276	E452N2N50011R2C
4261	2210505277	E452N2N50011R2D
4262	2210505278	E452N2N50011R2E
4263	2210505279	E452N2N50011R2G
4264	2210505280	E452N2N50011R2H
4265	2210505281	E452N2N50011R2K
4266	2210505282	E452N2N50011R2L
4267	2210505283	E452N2N50011R2M
4268	2210505284	E452N2N50011S01
4269	2210505285	E452N2N50011S02
4270	2210505286	E452N2N50011S03
4271	2210505287	E452N2N50011S04
4272	2210505288	E452N2N50011S05
4273	2210505289	E452N2N50011S0A
4274	2210505290	E452N2N50011S0B
4275	2210505291	E452N2N50011S0C
4276	2210505292	E452N2N50011S0D
4277	2210505293	E452N2N50011S0E
4278	2210505294	E452N2N50011S0G
4279	2210505295	E452N2N50011S0H
4280	2210505296	E452N2N50011S0K

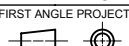
Pos.	Molex PN:	Engineering No.:
4281	2210505297	E452N2N50011S0L
4282	2210505298	E452N2N50011S0M
4283	2210505299	E452N3N10011A13
4284	2210505300	E452N3N10011A14
4285	2210505301	E452N3N10011A15
4286	2210505302	E452N3N10011A1A
4287	2210505303	E452N3N10011A1B
4288	2210505304	E452N3N10011A1C
4289	2210505305	E452N3N10011A1D
4290	2210505306	E452N3N10011A1E
4291	2210505307	E452N3N10011A1G
4292	2210505308	E452N3N10011A1H
4293	2210505309	E452N3N10011A1K
4294	2210505310	E452N3N10011A1L
4295	2210505311	E452N3N10011A1M
4296	2210505312	E452N3N10011C31
4297	2210505313	E452N3N10011C32
4298	2210505314	E452N3N10011C33
4299	2210505315	E452N3N10011C34
4300	2210505316	E452N3N10011C35
4301	2210505317	E452N3N10011C3A
4302	2210505318	E452N3N10011C3B
4303	2210505319	E452N3N10011C3C
4304	2210505320	E452N3N10011C3D
4305	2210505321	E452N3N10011C3E
4306	2210505322	E452N3N10011C3H
4307	2210505323	E452N3N10011C3K
4308	2210505324	E452N3N10011C3L
4309	2210505325	E452N3N10011C3M
4310	2210505326	E452N3N10011C43
4311	2210505327	E452N3N10011C44
4312	2210505328	E452N3N10011C4A
4313	2210505329	E452N3N10011C4C
4314	2210505330	E452N3N10011C4D
4315	2210505331	E452N3N10011C4E
4316	2210505332	E452N3N10011C4G
4317	2210505333	E452N3N10011C4K
4318	2210505338	E452N3N10011E05
4319	2210505353	E452N3N10011R05
4320	2210505364	E452N3N10011R21

THIS DRAWING CONTAINS INFORMATION THAT IS PROPRIETARY TO MOLEX ELECTRONIC TECHNOLOGIES, LLC AND SHOULD NOT BE USED WITHOUT WRITTEN PERMISSION									
DIMENSION UNITS		SCALE		CURRENT REV DESC: REVISION CREATED FOR REMOVING PRE-RELEASE STAMP				 E452XXXXXXXXXX DIN FORM A EN 175301-803	
mm		NTS							
GENERAL TOLERANCES (UNLESS SPECIFIED)									
		MM		INCH					
4 PLACES		±		±					
3 PLACES		±		±					
2 PLACES		±		±					
1 PLACE		±		±					
0 PLACES		±		±					
ANGULAR TOL		±		°					
DRAFT WHERE APPLICABLE MUST REMAIN WITHIN DIMENSIONS				FIRST ANGLE PROJECTION		DRAWING		SERIES	
						A3-SIZE		121050	
DOCUMENT STATUS		P1		RELEASE DATE		2022/07/19		09:04:35	
		9		8		7		6	
		5		4		3		2	
		1							

TABLE 3 - PART LIST

Pos.	Molex PN:	Engineering No.:
4321	2210505365	E452N3N10011R22
4322	2210505366	E452N3N10011R23
4323	2210505367	E452N3N10011R24
4324	2210505368	E452N3N10011R25
4325	2210505369	E452N3N10011R2A
4326	2210505370	E452N3N10011R2B
4327	2210505371	E452N3N10011R2C
4328	2210505372	E452N3N10011R2D
4329	2210505373	E452N3N10011R2E
4330	2210505374	E452N3N10011R2G
4331	2210505375	E452N3N10011R2K
4332	2210505376	E452N3N10011R2L
4333	2210505377	E452N3N10011R2M
4334	2210505378	E452N3N10011S01
4335	2210505379	E452N3N10011S02
4336	2210505380	E452N3N10011S03
4337	2210505381	E452N3N10011S04
4338	2210505382	E452N3N10011S05
4339	2210505383	E452N3N10011S0A
4340	2210505384	E452N3N10011S0B
4341	2210505385	E452N3N10011S0C
4342	2210505386	E452N3N10011S0D
4343	2210505387	E452N3N10011S0E
4344	2210505388	E452N3N10011S0G
4345	2210505389	E452N3N10011S0H
4346	2210505390	E452N3N10011S0K
4347	2210505391	E452N3N10011S0L
4348	2210505392	E452N3N10011S0M
4349	2210505393	E452N3N10K11000
4350	2210505394	E452N3N10K11A11
4351	2210505395	E452N3N10K11A12
4352	2210505396	E452N3N10K11A13
4353	2210505397	E452N3N10K11A14
4354	2210505398	E452N3N10K11A15
4355	2210505399	E452N3N10K11A1A
4356	2210505400	E452N3N10K11A1B
4357	2210505401	E452N3N10K11A1C
4358	2210505402	E452N3N10K11A1D
4359	2210505403	E452N3N10K11A1E
4360	2210505404	E452N3N10K11A1G

Pos.	Molex PN:	Engineering No.:
4361	2210505405	E452N3N10K11A1H
4362	2210505406	E452N3N10K11A1K
4363	2210505407	E452N3N10K11A1L
4364	2210505408	E452N3N10K11A1M
4365	2210505409	E452N3N10K11C31
4366	2210505410	E452N3N10K11C32
4367	2210505411	E452N3N10K11C33
4368	2210505412	E452N3N10K11C34
4369	2210505413	E452N3N10K11C35
4370	2210505414	E452N3N10K11C3A
4371	2210505415	E452N3N10K11C3B
4372	2210505416	E452N3N10K11C3C
4373	2210505417	E452N3N10K11C3D
4374	2210505418	E452N3N10K11C3E
4375	2210505419	E452N3N10K11C3G
4376	2210505420	E452N3N10K11C3H
4377	2210505421	E452N3N10K11C3K
4378	2210505422	E452N3N10K11C3L
4379	2210505423	E452N3N10K11C3M
4380	2210505424	E452N3N10K11C41
4381	2210505425	E452N3N10K11C43
4382	2210505426	E452N3N10K11C44
4383	2210505427	E452N3N10K11C45
4384	2210505428	E452N3N10K11C4A
4385	2210505429	E452N3N10K11C4B
4386	2210505430	E452N3N10K11C4C
4387	2210505431	E452N3N10K11C4D
4388	2210505432	E452N3N10K11C4E
4389	2210505433	E452N3N10K11C4G
4390	2210505434	E452N3N10K11C4K
4391	2210505435	E452N3N10K11C4M
4392	2210505440	E452N3N10K11E05
4393	2210505455	E452N3N10K11R05
4394	2210505466	E452N3N10K11R21
4395	2210505467	E452N3N10K11R22
4396	2210505468	E452N3N10K11R23
4397	2210505469	E452N3N10K11R24
4398	2210505470	E452N3N10K11R25
4399	2210505471	E452N3N10K11R2A
4400	2210505472	E452N3N10K11R2B

Pos.	Molex PN:	Engineering No.:
4401	2210505473	E452N3N10K11R2C
4402	2210505474	E452N3N10K11R2D
4403	2210505475	E452N3N10K11R2E
4404	2210505476	E452N3N10K11R2G
4405	2210505477	E452N3N10K11R2H
4406	2210505478	E452N3N10K11R2K
4407	2210505479	E452N3N10K11R2L
4408	2210505480	E452N3N10K11R2M
4409	2210505481	E452N3N10K11S01
4410	2210505482	E452N3N10K11S03
4411	2210505483	E452N3N10K11S04
4412	2210505484	E452N3N10K11S05
4413	2210505485	E452N3N10K11S0A
4414	2210505486	E452N3N10K11S0B
4415	2210505487	E452N3N10K11S0C
4416	2210505488	E452N3N10K11S0D
4417	2210505489	E452N3N10K11S0E
4418	2210505490	E452N3N10K11S0G
4419	2210505491	E452N3N10K11S0K
4420	2210505492	E452N3N10K11S0L
4421	2210505493	E452N3N10K11S0M
4422	2210505494	E452N3N15011000
4423	2210505495	E452N3N15011A13
4424	2210505496	E452N3N15011A14
4425	2210505497	E452N3N15011A1A
4426	2210505498	E452N3N15011A1B
4427	2210505499	E452N3N15011A1C
4428	2210505500	E452N3N15011A1D
4429	2210505501	E452N3N15011A1E
4430	2210505502	E452N3N15011A1G
4431	2210505503	E452N3N15011A1H
4432	2210505504	E452N3N15011A1K
4433	2210505505	E452N3N15011A1L
4434	2210505506	E452N3N15011A1M
4435	2210505507	E452N3N15011C31
4436	2210505508	E452N3N15011C33
4437	2210505509	E452N3N15011C34
4438	2210505510	E452N3N15011C35
4439	2210505511	E452N3N15011C3B
4440	2210505512	E452N3N15011C3C

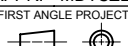
Pos.	Molex PN:	Engineering No.:
4441	2210505513	E452N3N15011C3D
4442	2210505514	E452N3N15011C3E
4443	2210505515	E452N3N15011C3G
4444	2210505516	E452N3N15011C3H
4445	2210505517	E452N3N15011C3K
4446	2210505518	E452N3N15011C3L
4447	2210505519	E452N3N15011C3M
4448	2210505520	E452N3N15011C41
4449	2210505521	E452N3N15011C42
4450	2210505522	E452N3N15011C43
4451	2210505523	E452N3N15011C44
4452	2210505524	E452N3N15011C45
4453	2210505525	E452N3N15011C4A
4454	2210505526	E452N3N15011C4B
4455	2210505527	E452N3N15011C4C
4456	2210505528	E452N3N15011C4D
4457	2210505529	E452N3N15011C4E
4458	2210505530	E452N3N15011C4G
4459	2210505531	E452N3N15011C4H
4460	2210505532	E452N3N15011C4K
4461	2210505533	E452N3N15011C4L
4462	2210505534	E452N3N15011C4M
4463	2210505539	E452N3N15011E05
4464	2210505554	E452N3N15011R05
4465	2210505565	E452N3N15011R21
4466	2210505566	E452N3N15011R22
4467	2210505567	E452N3N15011R23
4468	2210505568	E452N3N15011R24
4469	2210505569	E452N3N15011R25
4470	2210505570	E452N3N15011R2A
4471	2210505571	E452N3N15011R2B
4472	2210505572	E452N3N15011R2C
4473	2210505573	E452N3N15011R2D
4474	2210505574	E452N3N15011R2E
4475	2210505575	E452N3N15011R2G
4476	2210505576	E452N3N15011R2H
4477	2210505577	E452N3N15011R2K
4478	2210505578	E452N3N15011R2L
4479	2210505579	E452N3N15011R2M
4480	2210505580	E452N3N15011S01

THIS DRAWING CONTAINS INFORMATION THAT IS PROPRIETARY TO MOLEX ELECTRONIC TECHNOLOGIES, LLC AND SHOULD NOT BE USED WITHOUT WRITTEN PERMISSION									
DIMENSION UNITS		SCALE		CURRENT REV DESC: REVISION CREATED FOR REMOVING PRE-RELEASE STAMP				 E452XXXXXXXXXX DIN FORM A EN 175301-803	
mm		NTS							
GENERAL TOLERANCES (UNLESS SPECIFIED)									
		MM		INCH					
4 PLACES		±		±					
3 PLACES		±		±					
2 PLACES		±		±					
1 PLACE		±		±					
0 PLACES		±		±					
ANGULAR TOL		±		°					
DRAFT WHERE APPLICABLE MUST REMAIN WITHIN DIMENSIONS				FIRST ANGLE PROJECTION		DRAWING		SERIES	
						A3-SIZE		121050	
DOCUMENT STATUS		P1		RELEASE DATE		2022/07/19		09:04:35	
DOCUMENT NUMBER		SD-121050-001		DOC TYPE		PSD		DOC PART	
REVISION		001		REVISION		E1		SHEET NUMBER	
MATERIAL NUMBER		SEE TABLE		CUSTOMER		GENERAL MARKET		31 OF 41	

TABLE 3 - PART LIST

Pos.	Molex PN:	Engineering No.:
4481	2210505581	E452N3N15011S02
4482	2210505582	E452N3N15011S03
4483	2210505583	E452N3N15011S04
4484	2210505584	E452N3N15011S05
4485	2210505585	E452N3N15011S0A
4486	2210505586	E452N3N15011S0B
4487	2210505587	E452N3N15011S0C
4488	2210505588	E452N3N15011S0D
4489	2210505589	E452N3N15011S0E
4490	2210505590	E452N3N15011S0G
4491	2210505591	E452N3N15011S0H
4492	2210505592	E452N3N15011S0K
4493	2210505593	E452N3N15011S0L
4494	2210505594	E452N3N15011S0M
4495	2210505595	E452N3N20011000
4496	2210505596	E452N3N20011A13
4497	2210505597	E452N3N20011A15
4498	2210505598	E452N3N20011A1A
4499	2210505599	E452N3N20011A1B
4500	2210505600	E452N3N20011A1C
4501	2210505601	E452N3N20011A1D
4502	2210505602	E452N3N20011A1E
4503	2210505603	E452N3N20011A1G
4504	2210505604	E452N3N20011A1K
4505	2210505605	E452N3N20011A1L
4506	2210505606	E452N3N20011A1M
4507	2210505607	E452N3N20011C31
4508	2210505608	E452N3N20011C32
4509	2210505609	E452N3N20011C33
4510	2210505610	E452N3N20011C34
4511	2210505611	E452N3N20011C35
4512	2210505612	E452N3N20011C3A
4513	2210505613	E452N3N20011C3B
4514	2210505614	E452N3N20011C3C
4515	2210505615	E452N3N20011C3D
4516	2210505616	E452N3N20011C3E
4517	2210505617	E452N3N20011C3G
4518	2210505618	E452N3N20011C3H
4519	2210505619	E452N3N20011C3K
4520	2210505620	E452N3N20011C3L

Pos.	Molex PN:	Engineering No.:
4521	2210505621	E452N3N20011C3M
4522	2210505622	E452N3N20011C43
4523	2210505623	E452N3N20011C44
4524	2210505624	E452N3N20011C45
4525	2210505625	E452N3N20011C4A
4526	2210505626	E452N3N20011C4B
4527	2210505627	E452N3N20011C4C
4528	2210505628	E452N3N20011C4D
4529	2210505629	E452N3N20011C4E
4530	2210505630	E452N3N20011C4G
4531	2210505631	E452N3N20011C4K
4532	2210505632	E452N3N20011C4M
4533	2210505637	E452N3N20011E05
4534	2210505662	E452N3N20011R21
4535	2210505663	E452N3N20011R22
4536	2210505664	E452N3N20011R23
4537	2210505665	E452N3N20011R24
4538	2210505666	E452N3N20011R25
4539	2210505667	E452N3N20011R2A
4540	2210505668	E452N3N20011R2B
4541	2210505669	E452N3N20011R2C
4542	2210505670	E452N3N20011R2D
4543	2210505671	E452N3N20011R2E
4544	2210505672	E452N3N20011R2G
4545	2210505673	E452N3N20011R2K
4546	2210505674	E452N3N20011R2L
4547	2210505675	E452N3N20011S01
4548	2210505676	E452N3N20011S02
4549	2210505677	E452N3N20011S03
4550	2210505678	E452N3N20011S04
4551	2210505679	E452N3N20011S05
4552	2210505680	E452N3N20011S0A
4553	2210505681	E452N3N20011S0B
4554	2210505682	E452N3N20011S0C
4555	2210505683	E452N3N20011S0D
4556	2210505684	E452N3N20011S0E
4557	2210505685	E452N3N20011S0G
4558	2210505686	E452N3N20011S0H
4559	2210505687	E452N3N20011S0K
4560	2210505688	E452N3N20011S0L

Pos.	Molex PN:	Engineering No.:
4561	2210505689	E452N3N20011S0M
4562	2210505690	E452N3N30011000
4563	2210505691	E452N3N30011A12
4564	2210505692	E452N3N30011A13
4565	2210505693	E452N3N30011A14
4566	2210505694	E452N3N30011A15
4567	2210505695	E452N3N30011A1A
4568	2210505696	E452N3N30011A1B
4569	2210505697	E452N3N30011A1C
4570	2210505698	E452N3N30011A1D
4571	2210505699	E452N3N30011A1E
4572	2210505700	E452N3N30011A1G
4573	2210505701	E452N3N30011A1K
4574	2210505702	E452N3N30011A1L
4575	2210505703	E452N3N30011A1M
4576	2210505704	E452N3N30011C31
4577	2210505705	E452N3N30011C33
4578	2210505706	E452N3N30011C34
4579	2210505707	E452N3N30011C35
4580	2210505708	E452N3N30011C3A
4581	2210505709	E452N3N30011C3B
4582	2210505710	E452N3N30011C3C
4583	2210505711	E452N3N30011C3D
4584	2210505712	E452N3N30011C3E
4585	2210505713	E452N3N30011C3G
4586	2210505714	E452N3N30011C3H
4587	2210505715	E452N3N30011C3K
4588	2210505716	E452N3N30011C3L
4589	2210505717	E452N3N30011C3M
4590	2210505718	E452N3N30011C43
4591	2210505719	E452N3N30011C4A
4592	2210505720	E452N3N30011C4B
4593	2210505721	E452N3N30011C4C
4594	2210505722	E452N3N30011C4D
4595	2210505723	E452N3N30011C4E
4596	2210505724	E452N3N30011C4G
4597	2210505725	E452N3N30011C4K
4598	2210505730	E452N3N30011E05
4599	2210505745	E452N3N30011R05
4600	2210505756	E452N3N30011R21

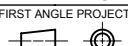
Pos.	Molex PN:	Engineering No.:
4601	2210505757	E452N3N30011R23
4602	2210505758	E452N3N30011R24
4603	2210505759	E452N3N30011R25
4604	2210505760	E452N3N30011R2A
4605	2210505761	E452N3N30011R2B
4606	2210505762	E452N3N30011R2C
4607	2210505763	E452N3N30011R2D
4608	2210505764	E452N3N30011R2E
4609	2210505765	E452N3N30011R2G
4610	2210505766	E452N3N30011R2K
4611	2210505767	E452N3N30011R2L
4612	2210505768	E452N3N30011R2M
4613	2210505769	E452N3N30011S01
4614	2210505770	E452N3N30011S02
4615	2210505771	E452N3N30011S03
4616	2210505772	E452N3N30011S04
4617	2210505773	E452N3N30011S05
4618	2210505774	E452N3N30011S0A
4619	2210505775	E452N3N30011S0B
4620	2210505776	E452N3N30011S0C
4621	2210505777	E452N3N30011S0E
4622	2210505778	E452N3N30011S0G
4623	2210505779	E452N3N30011S0H
4624	2210505780	E452N3N30011S0K
4625	2210505781	E452N3N30011S0L
4626	2210505782	E452N3N30011S0M
4627	2210505783	E452N3N50011000
4628	2210505784	E452N3N50011A11
4629	2210505785	E452N3N50011A12
4630	2210505786	E452N3N50011A13
4631	2210505787	E452N3N50011A14
4632	2210505788	E452N3N50011A15
4633	2210505789	E452N3N50011A1A
4634	2210505790	E452N3N50011A1C
4635	2210505791	E452N3N50011A1D
4636	2210505792	E452N3N50011A1E
4637	2210505793	E452N3N50011A1G
4638	2210505794	E452N3N50011A1H
4639	2210505795	E452N3N50011A1K
4640	2210505796	E452N3N50011A1L

THIS DRAWING CONTAINS INFORMATION THAT IS PROPRIETARY TO MOLEX ELECTRONIC TECHNOLOGIES, LLC AND SHOULD NOT BE USED WITHOUT WRITTEN PERMISSION									
DIMENSION UNITS		SCALE		CURRENT REV DESC: REVISION CREATED FOR REMOVING PRE-RELEASE STAMP				 E452XXXXXXXXXX DIN FORM A EN 175301-803	
mm		NTS							
GENERAL TOLERANCES (UNLESS SPECIFIED)				EC NO: 714567		2022/07/18		PRODUCT CUSTOMER DRAWING	
				DRWN: SUGEEB		2022/07/19			
				CHK'D: GGA		2022/07/19		DOCUMENT NUMBER	
				APPR: GGA		2022/07/19			
				INITIAL REVISION:				SD-121050-001	
				DRWN: JMARSZALEK		2012/08/27			
				APPR: MDYSZEWSKA		2012/08/20		DOC TYPE	
				ANGULAR TOL				DOC PART	
				DRAFT WHERE APPLICABLE				REVISION	
				MUST REMAIN WITHIN DIMENSIONS				E1	
				FIRST ANGLE PROJECTION		DRAWING		SHEET NUMBER	
						A3-SIZE		32 OF 41	
				SERIES		MATERIAL NUMBER		CUSTOMER	
				121050		SEE TABLE		GENERAL MARKET	

TABLE 3 - PART LIST

Pos.	Molex PN:	Engineering No.:
4641	2210505797	E452N3N50011A1M
4642	2210505798	E452N3N50011C31
4643	2210505799	E452N3N50011C32
4644	2210505800	E452N3N50011C33
4645	2210505801	E452N3N50011C34
4646	2210505802	E452N3N50011C35
4647	2210505803	E452N3N50011C3A
4648	2210505804	E452N3N50011C3B
4649	2210505805	E452N3N50011C3C
4650	2210505806	E452N3N50011C3D
4651	2210505807	E452N3N50011C3E
4652	2210505808	E452N3N50011C3G
4653	2210505809	E452N3N50011C3K
4654	2210505810	E452N3N50011C3L
4655	2210505811	E452N3N50011C3M
4656	2210505812	E452N3N50011C41
4657	2210505813	E452N3N50011C43
4658	2210505814	E452N3N50011C45
4659	2210505815	E452N3N50011C4A
4660	2210505816	E452N3N50011C4C
4661	2210505817	E452N3N50011C4G
4662	2210505818	E452N3N50011C4K
4663	2210505823	E452N3N50011E05
4664	2210505838	E452N3N50011R05
4665	2210505849	E452N3N50011R21
4666	2210505850	E452N3N50011R22
4667	2210505851	E452N3N50011R23
4668	2210505852	E452N3N50011R24
4669	2210505853	E452N3N50011R25
4670	2210505854	E452N3N50011R2A
4671	2210505855	E452N3N50011R2B
4672	2210505856	E452N3N50011R2C
4673	2210505857	E452N3N50011R2D
4674	2210505858	E452N3N50011R2E
4675	2210505859	E452N3N50011R2G
4676	2210505860	E452N3N50011R2H
4677	2210505861	E452N3N50011R2K
4678	2210505862	E452N3N50011R2L
4679	2210505863	E452N3N50011R2M
4680	2210505864	E452N3N50011S01

Pos.	Molex PN:	Engineering No.:
4681	2210505865	E452N3N50011S03
4682	2210505866	E452N3N50011S04
4683	2210505867	E452N3N50011S05
4684	2210505868	E452N3N50011S0A
4685	2210505869	E452N3N50011S0B
4686	2210505870	E452N3N50011S0C
4687	2210505871	E452N3N50011S0E
4688	2210505872	E452N3N50011S0G
4689	2210505873	E452N3N50011S0K
4690	2210505874	E452N3N50011S0L
4691	2210505875	E452N3N50011S0M
4692	2210505876	E452N4N10011000
4693	2210505877	E452N4N10011A11
4694	2210505878	E452N4N10011A12
4695	2210505879	E452N4N10011A13
4696	2210505880	E452N4N10011A14
4697	2210505881	E452N4N10011A15
4698	2210505882	E452N4N10011A1A
4699	2210505883	E452N4N10011A1B
4700	2210505884	E452N4N10011A1C
4701	2210505885	E452N4N10011A1D
4702	2210505886	E452N4N10011A1E
4703	2210505887	E452N4N10011A1G
4704	2210505888	E452N4N10011A1H
4705	2210505889	E452N4N10011A1K
4706	2210505890	E452N4N10011A1L
4707	2210505891	E452N4N10011A1M
4708	2210505892	E452N4N10011C31
4709	2210505893	E452N4N10011C32
4710	2210505894	E452N4N10011C33
4711	2210505895	E452N4N10011C34
4712	2210505896	E452N4N10011C35
4713	2210505897	E452N4N10011C3A
4714	2210505898	E452N4N10011C3B
4715	2210505899	E452N4N10011C3C
4716	2210505900	E452N4N10011C3D
4717	2210505901	E452N4N10011C3E
4718	2210505902	E452N4N10011C3G
4719	2210505903	E452N4N10011C3H
4720	2210505904	E452N4N10011C3K

Pos.	Molex PN:	Engineering No.:
4721	2210505905	E452N4N10011C3L
4722	2210505906	E452N4N10011C3M
4723	2210505907	E452N4N10011C41
4724	2210505908	E452N4N10011C42
4725	2210505909	E452N4N10011C43
4726	2210505910	E452N4N10011C44
4727	2210505911	E452N4N10011C45
4728	2210505912	E452N4N10011C4A
4729	2210505913	E452N4N10011C4B
4730	2210505914	E452N4N10011C4C
4731	2210505915	E452N4N10011C4D
4732	2210505916	E452N4N10011C4E
4733	2210505917	E452N4N10011C4G
4734	2210505918	E452N4N10011C4H
4735	2210505919	E452N4N10011C4K
4736	2210505920	E452N4N10011C4L
4737	2210505921	E452N4N10011C4M
4738	2210505926	E452N4N10011E05
4739	2210505941	E452N4N10011R05
4740	2210505952	E452N4N10011R21
4741	2210505953	E452N4N10011R22
4742	2210505954	E452N4N10011R23
4743	2210505955	E452N4N10011R24
4744	2210505956	E452N4N10011R25
4745	2210505957	E452N4N10011R2A
4746	2210505958	E452N4N10011R2B
4747	2210505959	E452N4N10011R2C
4748	2210505960	E452N4N10011R2D
4749	2210505961	E452N4N10011R2E
4750	2210505962	E452N4N10011R2G
4751	2210505963	E452N4N10011R2H
4752	2210505964	E452N4N10011R2K
4753	2210505965	E452N4N10011R2L
4754	2210505966	E452N4N10011R2M
4755	2210505967	E452N4N10011S01
4756	2210505968	E452N4N10011S02
4757	2210505969	E452N4N10011S03
4758	2210505970	E452N4N10011S04
4759	2210505971	E452N4N10011S05
4760	2210505972	E452N4N10011S0A

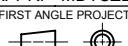
Pos.	Molex PN:	Engineering No.:
4761	2210505973	E452N4N10011S0B
4762	2210505974	E452N4N10011S0C
4763	2210505975	E452N4N10011S0D
4764	2210505976	E452N4N10011S0E
4765	2210505977	E452N4N10011S0G
4766	2210505978	E452N4N10011S0H
4767	2210505979	E452N4N10011S0K
4768	2210505980	E452N4N10011S0L
4769	2210505981	E452N4N10011S0M
4770	2210505982	E452N4N10K11000
4771	2210505983	E452N4N10K11A11
4772	2210505984	E452N4N10K11A12
4773	2210505985	E452N4N10K11A13
4774	2210505986	E452N4N10K11A14
4775	2210505987	E452N4N10K11A15
4776	2210505988	E452N4N10K11A1A
4777	2210505989	E452N4N10K11A1B
4778	2210505990	E452N4N10K11A1C
4779	2210505991	E452N4N10K11A1D
4780	2210505992	E452N4N10K11A1E
4781	2210505993	E452N4N10K11A1G
4782	2210505994	E452N4N10K11A1H
4783	2210505995	E452N4N10K11A1K
4784	2210505996	E452N4N10K11A1L
4785	2210505997	E452N4N10K11A1M
4786	2210505998	E452N4N10K11C31
4787	2210505999	E452N4N10K11C32
4788	2210506000	E452N4N10K11C33
4789	2210506001	E452N4N10K11C34
4790	2210506002	E452N4N10K11C35
4791	2210506003	E452N4N10K11C3A
4792	2210506004	E452N4N10K11C3B
4793	2210506005	E452N4N10K11C3C
4794	2210506006	E452N4N10K11C3D
4795	2210506007	E452N4N10K11C3E
4796	2210506008	E452N4N10K11C3G
4797	2210506009	E452N4N10K11C3H
4798	2210506010	E452N4N10K11C3K
4799	2210506011	E452N4N10K11C3L
4800	2210506012	E452N4N10K11C3M

THIS DRAWING CONTAINS INFORMATION THAT IS PROPRIETARY TO MOLEX ELECTRONIC TECHNOLOGIES, LLC AND SHOULD NOT BE USED WITHOUT WRITTEN PERMISSION									
DIMENSION UNITS		SCALE		CURRENT REV DESC: REVISION CREATED FOR REMOVING PRE-RELEASE STAMP				 E452XXXXXXXXXX DIN FORM A EN 175301-803	
mm		NTS							
GENERAL TOLERANCES (UNLESS SPECIFIED)				EC NO: 714567		2022/07/18		PRODUCT CUSTOMER DRAWING DOCUMENT NUMBER: SD-121050-001 DOC TYPE: PSD DOC PART: 001 REVISION: E1	
				DRWN: SUGEEB		2022/07/19			
				CHK'D: GGA		2022/07/19			
				APPR: GGA					
				INITIAL REVISION:					
				DRWN: JMARSZALEK		2012/08/27			
				APPR: MDYSZEWSKA		2012/08/20			
DRAFT WHERE APPLICABLE MUST REMAIN WITHIN DIMENSIONS				FIRST ANGLE PROJECTION		DRAWING		SERIES	
						A3-SIZE		121050	
				MATERIAL NUMBER		CUSTOMER		SHEET NUMBER	
				SEE TABLE		GENERAL MARKET		33 OF 41	

TABLE 3 - PART LIST

Pos.	Molex PN:	Engineering No.:
4801	2210506013	E452N4N10K11C41
4802	2210506014	E452N4N10K11C42
4803	2210506015	E452N4N10K11C43
4804	2210506016	E452N4N10K11C44
4805	2210506017	E452N4N10K11C45
4806	2210506018	E452N4N10K11C4A
4807	2210506019	E452N4N10K11C4B
4808	2210506020	E452N4N10K11C4C
4809	2210506021	E452N4N10K11C4D
4810	2210506022	E452N4N10K11C4E
4811	2210506023	E452N4N10K11C4G
4812	2210506024	E452N4N10K11C4H
4813	2210506025	E452N4N10K11C4K
4814	2210506026	E452N4N10K11C4L
4815	2210506027	E452N4N10K11C4M
4816	2210506032	E452N4N10K11E05
4817	2210506047	E452N4N10K11R05
4818	2210506058	E452N4N10K11R21
4819	2210506059	E452N4N10K11R22
4820	2210506060	E452N4N10K11R23
4821	2210506061	E452N4N10K11R24
4822	2210506062	E452N4N10K11R25
4823	2210506063	E452N4N10K11R2A
4824	2210506064	E452N4N10K11R2B
4825	2210506065	E452N4N10K11R2C
4826	2210506066	E452N4N10K11R2D
4827	2210506067	E452N4N10K11R2E
4828	2210506068	E452N4N10K11R2G
4829	2210506069	E452N4N10K11R2H
4830	2210506070	E452N4N10K11R2K
4831	2210506071	E452N4N10K11R2L
4832	2210506072	E452N4N10K11R2M
4833	2210506073	E452N4N10K11S01
4834	2210506074	E452N4N10K11S02
4835	2210506075	E452N4N10K11S03
4836	2210506076	E452N4N10K11S04
4837	2210506077	E452N4N10K11S05
4838	2210506078	E452N4N10K11S0A
4839	2210506079	E452N4N10K11S0B
4840	2210506080	E452N4N10K11S0C

Pos.	Molex PN:	Engineering No.:
4841	2210506081	E452N4N10K11S0D
4842	2210506082	E452N4N10K11S0E
4843	2210506083	E452N4N10K11S0G
4844	2210506084	E452N4N10K11S0H
4845	2210506085	E452N4N10K11S0K
4846	2210506086	E452N4N10K11S0L
4847	2210506087	E452N4N10K11S0M
4848	2210506088	E452N4N15011000
4849	2210506089	E452N4N15011A11
4850	2210506090	E452N4N15011A12
4851	2210506091	E452N4N15011A13
4852	2210506092	E452N4N15011A14
4853	2210506093	E452N4N15011A15
4854	2210506094	E452N4N15011A1A
4855	2210506095	E452N4N15011A1B
4856	2210506096	E452N4N15011A1C
4857	2210506097	E452N4N15011A1D
4858	2210506098	E452N4N15011A1E
4859	2210506099	E452N4N15011A1G
4860	2210506100	E452N4N15011A1H
4861	2210506101	E452N4N15011A1K
4862	2210506102	E452N4N15011A1L
4863	2210506103	E452N4N15011A1M
4864	2210506104	E452N4N15011C31
4865	2210506105	E452N4N15011C32
4866	2210506106	E452N4N15011C33
4867	2210506107	E452N4N15011C34
4868	2210506108	E452N4N15011C35
4869	2210506109	E452N4N15011C3A
4870	2210506110	E452N4N15011C3B
4871	2210506111	E452N4N15011C3C
4872	2210506112	E452N4N15011C3D
4873	2210506113	E452N4N15011C3E
4874	2210506114	E452N4N15011C3G
4875	2210506115	E452N4N15011C3H
4876	2210506116	E452N4N15011C3K
4877	2210506117	E452N4N15011C3L
4878	2210506118	E452N4N15011C3M
4879	2210506119	E452N4N15011C41
4880	2210506120	E452N4N15011C42

Pos.	Molex PN:	Engineering No.:
4881	2210506121	E452N4N15011C43
4882	2210506122	E452N4N15011C44
4883	2210506123	E452N4N15011C45
4884	2210506124	E452N4N15011C4A
4885	2210506125	E452N4N15011C4B
4886	2210506126	E452N4N15011C4C
4887	2210506127	E452N4N15011C4D
4888	2210506128	E452N4N15011C4E
4889	2210506129	E452N4N15011C4G
4890	2210506130	E452N4N15011C4H
4891	2210506131	E452N4N15011C4K
4892	2210506132	E452N4N15011C4L
4893	2210506133	E452N4N15011C4M
4894	2210506138	E452N4N15011E05
4895	2210506153	E452N4N15011R05
4896	2210506164	E452N4N15011R21
4897	2210506165	E452N4N15011R22
4898	2210506166	E452N4N15011R23
4899	2210506167	E452N4N15011R24
4900	2210506168	E452N4N15011R25
4901	2210506169	E452N4N15011R2A
4902	2210506170	E452N4N15011R2B
4903	2210506171	E452N4N15011R2C
4904	2210506172	E452N4N15011R2D
4905	2210506173	E452N4N15011R2E
4906	2210506174	E452N4N15011R2G
4907	2210506175	E452N4N15011R2H
4908	2210506176	E452N4N15011R2K
4909	2210506177	E452N4N15011R2L
4910	2210506178	E452N4N15011R2M
4911	2210506179	E452N4N15011S01
4912	2210506180	E452N4N15011S02
4913	2210506181	E452N4N15011S03
4914	2210506182	E452N4N15011S04
4915	2210506183	E452N4N15011S05
4916	2210506184	E452N4N15011S0A
4917	2210506185	E452N4N15011S0B
4918	2210506186	E452N4N15011S0C
4919	2210506187	E452N4N15011S0D
4920	2210506188	E452N4N15011S0E

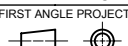
Pos.	Molex PN:	Engineering No.:
4921	2210506189	E452N4N15011S0G
4922	2210506190	E452N4N15011S0H
4923	2210506191	E452N4N15011S0K
4924	2210506192	E452N4N15011S0L
4925	2210506193	E452N4N15011S0M
4926	2210506194	E452N4N20011000
4927	2210506195	E452N4N20011A11
4928	2210506196	E452N4N20011A12
4929	2210506197	E452N4N20011A13
4930	2210506198	E452N4N20011A14
4931	2210506199	E452N4N20011A15
4932	2210506200	E452N4N20011A1A
4933	2210506201	E452N4N20011A1B
4934	2210506202	E452N4N20011A1C
4935	2210506203	E452N4N20011A1D
4936	2210506204	E452N4N20011A1E
4937	2210506205	E452N4N20011A1G
4938	2210506206	E452N4N20011A1H
4939	2210506207	E452N4N20011A1K
4940	2210506208	E452N4N20011A1L
4941	2210506209	E452N4N20011A1M
4942	2210506210	E452N4N20011C31
4943	2210506211	E452N4N20011C32
4944	2210506212	E452N4N20011C33
4945	2210506213	E452N4N20011C34
4946	2210506214	E452N4N20011C35
4947	2210506215	E452N4N20011C3A
4948	2210506216	E452N4N20011C3B
4949	2210506217	E452N4N20011C3C
4950	2210506218	E452N4N20011C3D
4951	2210506219	E452N4N20011C3E
4952	2210506220	E452N4N20011C3G
4953	2210506221	E452N4N20011C3H
4954	2210506222	E452N4N20011C3K
4955	2210506223	E452N4N20011C3L
4956	2210506224	E452N4N20011C3M
4957	2210506225	E452N4N20011C41
4958	2210506226	E452N4N20011C42
4959	2210506227	E452N4N20011C43
4960	2210506228	E452N4N20011C44

THIS DRAWING CONTAINS INFORMATION THAT IS PROPRIETARY TO MOLEX ELECTRONIC TECHNOLOGIES, LLC AND SHOULD NOT BE USED WITHOUT WRITTEN PERMISSION									
DIMENSION UNITS		SCALE		CURRENT REV DESC: REVISION CREATED FOR REMOVING PRE-RELEASE STAMP				 E452XXXXXXXXXX DIN FORM A EN 175301-803	
mm		NTS							
GENERAL TOLERANCES (UNLESS SPECIFIED)				EC NO: 714567		2022/07/18		PRODUCT CUSTOMER DRAWING DOCUMENT NUMBER: SD-121050-001 DOC TYPE: PSD DOC PART: 001 REVISION: E1	
				DRWN: SUGEEB		2022/07/19			
				CHK'D: GGA		2022/07/19			
				APPR: GGA					
				INITIAL REVISION:					
				DRWN: JMARSZALEK		2012/08/27			
				APPR: MDYSZEWSKA		2012/08/20			
DRAFT WHERE APPLICABLE MUST REMAIN WITHIN DIMENSIONS				FIRST ANGLE PROJECTION		DRAWING		SHEET NUMBER	
						A3-SIZE		34 OF 41	

TABLE 3 - PART LIST

Pos.	Molex PN:	Engineering No.:
4961	2210506229	E452N4N20011C45
4962	2210506230	E452N4N20011C4A
4963	2210506231	E452N4N20011C4B
4964	2210506232	E452N4N20011C4C
4965	2210506233	E452N4N20011C4D
4966	2210506234	E452N4N20011C4E
4967	2210506235	E452N4N20011C4G
4968	2210506236	E452N4N20011C4H
4969	2210506237	E452N4N20011C4K
4970	2210506238	E452N4N20011C4L
4971	2210506239	E452N4N20011C4M
4972	2210506244	E452N4N20011E05
4973	2210506259	E452N4N20011R05
4974	2210506270	E452N4N20011R21
4975	2210506271	E452N4N20011R22
4976	2210506272	E452N4N20011R23
4977	2210506273	E452N4N20011R24
4978	2210506274	E452N4N20011R25
4979	2210506275	E452N4N20011R2A
4980	2210506276	E452N4N20011R2B
4981	2210506277	E452N4N20011R2C
4982	2210506278	E452N4N20011R2D
4983	2210506279	E452N4N20011R2E
4984	2210506280	E452N4N20011R2G
4985	2210506281	E452N4N20011R2H
4986	2210506282	E452N4N20011R2K
4987	2210506283	E452N4N20011R2L
4988	2210506284	E452N4N20011R2M
4989	2210506285	E452N4N20011S01
4990	2210506286	E452N4N20011S02
4991	2210506287	E452N4N20011S03
4992	2210506288	E452N4N20011S04
4993	2210506289	E452N4N20011S05
4994	2210506290	E452N4N20011S0A
4995	2210506291	E452N4N20011S0B
4996	2210506292	E452N4N20011S0C
4997	2210506293	E452N4N20011S0D
4998	2210506294	E452N4N20011S0E
4999	2210506295	E452N4N20011S0G
5000	2210506296	E452N4N20011S0H

Pos.	Molex PN:	Engineering No.:
5001	2210506297	E452N4N20011S0K
5002	2210506298	E452N4N20011S0L
5003	2210506299	E452N4N20011S0M
5004	2210506300	E452N4N30011000
5005	2210506301	E452N4N30011A11
5006	2210506302	E452N4N30011A12
5007	2210506303	E452N4N30011A13
5008	2210506304	E452N4N30011A14
5009	2210506305	E452N4N30011A15
5010	2210506306	E452N4N30011A1A
5011	2210506307	E452N4N30011A1B
5012	2210506308	E452N4N30011A1C
5013	2210506309	E452N4N30011A1D
5014	2210506310	E452N4N30011A1E
5015	2210506311	E452N4N30011A1G
5016	2210506312	E452N4N30011A1H
5017	2210506313	E452N4N30011A1K
5018	2210506314	E452N4N30011A1L
5019	2210506315	E452N4N30011A1M
5020	2210506316	E452N4N30011C31
5021	2210506317	E452N4N30011C32
5022	2210506318	E452N4N30011C33
5023	2210506319	E452N4N30011C34
5024	2210506320	E452N4N30011C35
5025	2210506321	E452N4N30011C3A
5026	2210506322	E452N4N30011C3B
5027	2210506323	E452N4N30011C3C
5028	2210506324	E452N4N30011C3D
5029	2210506325	E452N4N30011C3E
5030	2210506326	E452N4N30011C3G
5031	2210506327	E452N4N30011C3H
5032	2210506328	E452N4N30011C3K
5033	2210506329	E452N4N30011C3L
5034	2210506330	E452N4N30011C3M
5035	2210506331	E452N4N30011C41
5036	2210506332	E452N4N30011C42
5037	2210506333	E452N4N30011C43
5038	2210506334	E452N4N30011C44
5039	2210506335	E452N4N30011C45
5040	2210506336	E452N4N30011C4A

Pos.	Molex PN:	Engineering No.:
5041	2210506337	E452N4N30011C4B
5042	2210506338	E452N4N30011C4C
5043	2210506339	E452N4N30011C4D
5044	2210506340	E452N4N30011C4E
5045	2210506341	E452N4N30011C4G
5046	2210506342	E452N4N30011C4H
5047	2210506343	E452N4N30011C4K
5048	2210506344	E452N4N30011C4L
5049	2210506345	E452N4N30011C4M
5050	2210506350	E452N4N30011E05
5051	2210506365	E452N4N30011R05
5052	2210506376	E452N4N30011R21
5053	2210506377	E452N4N30011R22
5054	2210506378	E452N4N30011R23
5055	2210506379	E452N4N30011R24
5056	2210506380	E452N4N30011R25
5057	2210506381	E452N4N30011R2A
5058	2210506382	E452N4N30011R2B
5059	2210506383	E452N4N30011R2C
5060	2210506384	E452N4N30011R2D
5061	2210506385	E452N4N30011R2E
5062	2210506386	E452N4N30011R2G
5063	2210506387	E452N4N30011R2H
5064	2210506388	E452N4N30011R2K
5065	2210506389	E452N4N30011R2L
5066	2210506390	E452N4N30011R2M
5067	2210506391	E452N4N30011S01
5068	2210506392	E452N4N30011S02
5069	2210506393	E452N4N30011S03
5070	2210506394	E452N4N30011S04
5071	2210506395	E452N4N30011S05
5072	2210506396	E452N4N30011S0A
5073	2210506397	E452N4N30011S0B
5074	2210506398	E452N4N30011S0C
5075	2210506399	E452N4N30011S0D
5076	2210506400	E452N4N30011S0E
5077	2210506401	E452N4N30011S0G
5078	2210506402	E452N4N30011S0H
5079	2210506403	E452N4N30011S0K
5080	2210506404	E452N4N30011S0L

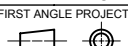
Pos.	Molex PN:	Engineering No.:
5081	2210506405	E452N4N30011S0M
5082	2210506406	E452N4N50011000
5083	2210506407	E452N4N50011A11
5084	2210506408	E452N4N50011A12
5085	2210506409	E452N4N50011A13
5086	2210506410	E452N4N50011A14
5087	2210506411	E452N4N50011A15
5088	2210506412	E452N4N50011A1A
5089	2210506413	E452N4N50011A1B
5090	2210506414	E452N4N50011A1C
5091	2210506415	E452N4N50011A1D
5092	2210506416	E452N4N50011A1E
5093	2210506417	E452N4N50011A1G
5094	2210506418	E452N4N50011A1H
5095	2210506419	E452N4N50011A1K
5096	2210506420	E452N4N50011A1L
5097	2210506421	E452N4N50011A1M
5098	2210506422	E452N4N50011C31
5099	2210506423	E452N4N50011C32
5100	2210506424	E452N4N50011C33
5101	2210506425	E452N4N50011C34
5102	2210506426	E452N4N50011C35
5103	2210506427	E452N4N50011C3A
5104	2210506428	E452N4N50011C3B
5105	2210506429	E452N4N50011C3C
5106	2210506430	E452N4N50011C3D
5107	2210506431	E452N4N50011C3E
5108	2210506432	E452N4N50011C3G
5109	2210506433	E452N4N50011C3H
5110	2210506434	E452N4N50011C3K
5111	2210506435	E452N4N50011C3L
5112	2210506436	E452N4N50011C3M
5113	2210506437	E452N4N50011C41
5114	2210506438	E452N4N50011C42
5115	2210506439	E452N4N50011C43
5116	2210506440	E452N4N50011C44
5117	2210506441	E452N4N50011C45
5118	2210506442	E452N4N50011C4A
5119	2210506443	E452N4N50011C4B
5120	2210506444	E452N4N50011C4C

THIS DRAWING CONTAINS INFORMATION THAT IS PROPRIETARY TO MOLEX ELECTRONIC TECHNOLOGIES, LLC AND SHOULD NOT BE USED WITHOUT WRITTEN PERMISSION									
DIMENSION UNITS		SCALE		CURRENT REV DESC: REVISION CREATED FOR REMOVING PRE-RELEASE STAMP				 E452XXXXXXXXXX DIN FORM A EN 175301-803	
mm		NTS							
GENERAL TOLERANCES (UNLESS SPECIFIED)				EC NO: 714567		2022/07/18		PRODUCT CUSTOMER DRAWING DOCUMENT NUMBER: SD-121050-001 DOC TYPE: PSD DOC PART: 001 REVISION: E1	
				DRWN: SUGEEB		2022/07/19			
				CHK'D: GGA		2022/07/19			
				APPR: GGA					
				INITIAL REVISION:					
				DRWN: JMARSZALEK		2012/08/27			
				APPR: MDYSZEWSKA		2012/08/20			
DRAFT WHERE APPLICABLE MUST REMAIN WITHIN DIMENSIONS				FIRST ANGLE PROJECTION		DRAWING		SHEET NUMBER	
						A3-SIZE		35 OF 41	

TABLE 3 - PART LIST

Pos.	Molex PN:	Engineering No.:
5121	2210506445	E452N4N50011C4D
5122	2210506446	E452N4N50011C4E
5123	2210506447	E452N4N50011C4G
5124	2210506448	E452N4N50011C4H
5125	2210506449	E452N4N50011C4K
5126	2210506450	E452N4N50011C4L
5127	2210506451	E452N4N50011C4M
5128	2210506456	E452N4N50011E05
5129	2210506471	E452N4N50011R05
5130	2210506482	E452N4N50011R21
5131	2210506483	E452N4N50011R22
5132	2210506484	E452N4N50011R23
5133	2210506485	E452N4N50011R24
5134	2210506486	E452N4N50011R25
5135	2210506487	E452N4N50011R2A
5136	2210506488	E452N4N50011R2B
5137	2210506489	E452N4N50011R2C
5138	2210506490	E452N4N50011R2D
5139	2210506491	E452N4N50011R2E
5140	2210506492	E452N4N50011R2G
5141	2210506493	E452N4N50011R2H
5142	2210506494	E452N4N50011R2K
5143	2210506495	E452N4N50011R2L
5144	2210506496	E452N4N50011R2M
5145	2210506497	E452N4N50011S01
5146	2210506498	E452N4N50011S02
5147	2210506499	E452N4N50011S03
5148	2210506500	E452N4N50011S04
5149	2210506501	E452N4N50011S05
5150	2210506502	E452N4N50011S0A
5151	2210506503	E452N4N50011S0B
5152	2210506504	E452N4N50011S0C
5153	2210506505	E452N4N50011S0D
5154	2210506506	E452N4N50011S0E
5155	2210506507	E452N4N50011S0G
5156	2210506508	E452N4N50011S0H
5157	2210506509	E452N4N50011S0K
5158	2210506510	E452N4N50011S0L
5159	2210506511	E452N4N50011S0M
5160	2210506512	E452P2N10011000

Pos.	Molex PN:	Engineering No.:
5161	2210506513	E452P2N10011A11
5162	2210506514	E452P2N10011A12
5163	2210506515	E452P2N10011A13
5164	2210506516	E452P2N10011A14
5165	2210506517	E452P2N10011A15
5166	2210506518	E452P2N10011A1A
5167	2210506519	E452P2N10011A1B
5168	2210506520	E452P2N10011A1C
5169	2210506521	E452P2N10011A1D
5170	2210506522	E452P2N10011A1E
5171	2210506523	E452P2N10011A1G
5172	2210506524	E452P2N10011A1H
5173	2210506525	E452P2N10011A1K
5174	2210506526	E452P2N10011A1L
5175	2210506527	E452P2N10011A1M
5176	2210506528	E452P2N10011C31
5177	2210506529	E452P2N10011C32
5178	2210506530	E452P2N10011C33
5179	2210506531	E452P2N10011C34
5180	2210506532	E452P2N10011C35
5181	2210506533	E452P2N10011C3A
5182	2210506534	E452P2N10011C3C
5183	2210506535	E452P2N10011C3D
5184	2210506536	E452P2N10011C3E
5185	2210506537	E452P2N10011C3G
5186	2210506538	E452P2N10011C3H
5187	2210506539	E452P2N10011C3K
5188	2210506540	E452P2N10011C3L
5189	2210506541	E452P2N10011C3M
5190	2210506542	E452P2N10011C41
5191	2210506543	E452P2N10011C42
5192	2210506544	E452P2N10011C43
5193	2210506545	E452P2N10011C44
5194	2210506546	E452P2N10011C45
5195	2210506547	E452P2N10011C4A
5196	2210506548	E452P2N10011C4B
5197	2210506549	E452P2N10011C4C
5198	2210506550	E452P2N10011C4D
5199	2210506551	E452P2N10011C4E
5200	2210506552	E452P2N10011C4G

Pos.	Molex PN:	Engineering No.:
5201	2210506553	E452P2N10011C4K
5202	2210506554	E452P2N10011C4L
5203	2210506555	E452P2N10011C4M
5204	2210506560	E452P2N10011E05
5205	2210506575	E452P2N10011R05
5206	2210506586	E452P2N10011R21
5207	2210506587	E452P2N10011R22
5208	2210506588	E452P2N10011R23
5209	2210506589	E452P2N10011R24
5210	2210506590	E452P2N10011R25
5211	2210506591	E452P2N10011R2A
5212	2210506592	E452P2N10011R2B
5213	2210506593	E452P2N10011R2C
5214	2210506594	E452P2N10011R2D
5215	2210506595	E452P2N10011R2E
5216	2210506596	E452P2N10011R2G
5217	2210506597	E452P2N10011R2H
5218	2210506598	E452P2N10011R2K
5219	2210506599	E452P2N10011R2L
5220	2210506600	E452P2N10011R2M
5221	2210506601	E452P2N10011S01
5222	2210506602	E452P2N10011S02
5223	2210506603	E452P2N10011S03
5224	2210506604	E452P2N10011S04
5225	2210506605	E452P2N10011S05
5226	2210506606	E452P2N10011S0A
5227	2210506607	E452P2N10011S0B
5228	2210506608	E452P2N10011S0C
5229	2210506609	E452P2N10011S0D
5230	2210506610	E452P2N10011S0E
5231	2210506611	E452P2N10011S0G
5232	2210506612	E452P2N10011S0H
5233	2210506613	E452P2N10011S0K
5234	2210506614	E452P2N10011S0L
5235	2210506615	E452P2N10011S0M
5236	2210506616	E452P2N10K11000
5237	2210506617	E452P2N10K11A11
5238	2210506618	E452P2N10K11A12
5239	2210506619	E452P2N10K11A13
5240	2210506620	E452P2N10K11A14

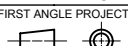
Pos.	Molex PN:	Engineering No.:
5241	2210506621	E452P2N10K11A15
5242	2210506622	E452P2N10K11A1A
5243	2210506623	E452P2N10K11A1B
5244	2210506624	E452P2N10K11A1C
5245	2210506625	E452P2N10K11A1D
5246	2210506626	E452P2N10K11A1E
5247	2210506627	E452P2N10K11A1G
5248	2210506628	E452P2N10K11A1H
5249	2210506629	E452P2N10K11A1K
5250	2210506630	E452P2N10K11A1L
5251	2210506631	E452P2N10K11A1M
5252	2210506632	E452P2N10K11C31
5253	2210506633	E452P2N10K11C32
5254	2210506634	E452P2N10K11C33
5255	2210506635	E452P2N10K11C34
5256	2210506636	E452P2N10K11C35
5257	2210506637	E452P2N10K11C3A
5258	2210506638	E452P2N10K11C3B
5259	2210506639	E452P2N10K11C3C
5260	2210506640	E452P2N10K11C3D
5261	2210506641	E452P2N10K11C3E
5262	2210506642	E452P2N10K11C3G
5263	2210506643	E452P2N10K11C3H
5264	2210506644	E452P2N10K11C3K
5265	2210506645	E452P2N10K11C3L
5266	2210506646	E452P2N10K11C3M
5267	2210506647	E452P2N10K11C41
5268	2210506648	E452P2N10K11C42
5269	2210506649	E452P2N10K11C43
5270	2210506650	E452P2N10K11C44
5271	2210506651	E452P2N10K11C45
5272	2210506652	E452P2N10K11C4A
5273	2210506653	E452P2N10K11C4B
5274	2210506654	E452P2N10K11C4C
5275	2210506655	E452P2N10K11C4D
5276	2210506656	E452P2N10K11C4E
5277	2210506657	E452P2N10K11C4G
5278	2210506658	E452P2N10K11C4K
5279	2210506659	E452P2N10K11C4L
5280	2210506660	E452P2N10K11C4M

THIS DRAWING CONTAINS INFORMATION THAT IS PROPRIETARY TO MOLEX ELECTRONIC TECHNOLOGIES, LLC AND SHOULD NOT BE USED WITHOUT WRITTEN PERMISSION									
DIMENSION UNITS		SCALE		CURRENT REV DESC: REVISION CREATED FOR REMOVING PRE-RELEASE STAMP					
mm		NTS							
GENERAL TOLERANCES (UNLESS SPECIFIED)				EC NO: 714567		2022/07/18		E452XXXXXXXXXX	
				DRWN: SUGEEB		2022/07/19		DIN FORM A EN 175301-803	
				CHK'D: GGA		2022/07/19		PRODUCT CUSTOMER DRAWING	
				APPR: GGA		2022/07/19		DOCUMENT NUMBER	
				INITIAL REVISION:				DOC TYPE	
				DRWN: JMARSZALEK		2012/08/27		DOC PART	
				APPR: MDYSZEWSKA		2012/08/20		REVISION	
				ANGULAR TOL				SD-121050-001	
				DRAFT WHERE APPLICABLE MUST REMAIN WITHIN DIMENSIONS		FIRST ANGLE PROJECTION		PSD	
						DRAWING		001	
						SERIES		E1	
						MATERIAL NUMBER		SEE TABLE	
						CUSTOMER		GENERAL MARKET	
						SHEET NUMBER		36 OF 41	

TABLE 3 - PART LIST

Pos.	Molex PN:	Engineering No.:
5281	2210506665	E452P2N10K11E05
5282	2210506680	E452P2N10K11R05
5283	2210506691	E452P2N10K11R21
5284	2210506692	E452P2N10K11R22
5285	2210506693	E452P2N10K11R23
5286	2210506694	E452P2N10K11R24
5287	2210506695	E452P2N10K11R25
5288	2210506696	E452P2N10K11R2A
5289	2210506697	E452P2N10K11R2B
5290	2210506698	E452P2N10K11R2C
5291	2210506699	E452P2N10K11R2D
5292	2210506700	E452P2N10K11R2E
5293	2210506701	E452P2N10K11R2G
5294	2210506702	E452P2N10K11R2H
5295	2210506703	E452P2N10K11R2K
5296	2210506704	E452P2N10K11R2L
5297	2210506705	E452P2N10K11R2M
5298	2210506706	E452P2N10K11S01
5299	2210506707	E452P2N10K11S02
5300	2210506708	E452P2N10K11S03
5301	2210506709	E452P2N10K11S04
5302	2210506710	E452P2N10K11S05
5303	2210506711	E452P2N10K11S0A
5304	2210506712	E452P2N10K11S0B
5305	2210506713	E452P2N10K11S0C
5306	2210506714	E452P2N10K11S0D
5307	2210506715	E452P2N10K11S0E
5308	2210506716	E452P2N10K11S0G
5309	2210506717	E452P2N10K11S0K
5310	2210506718	E452P2N10K11S0L
5311	2210506719	E452P2N10K11S0M
5312	2210506720	E452P2N15011000
5313	2210506721	E452P2N15011A11
5314	2210506722	E452P2N15011A12
5315	2210506723	E452P2N15011A13
5316	2210506724	E452P2N15011A14
5317	2210506725	E452P2N15011A15
5318	2210506726	E452P2N15011A1A
5319	2210506727	E452P2N15011A1B
5320	2210506728	E452P2N15011A1C

Pos.	Molex PN:	Engineering No.:
5321	2210506729	E452P2N15011A1D
5322	2210506730	E452P2N15011A1E
5323	2210506731	E452P2N15011A1G
5324	2210506732	E452P2N15011A1H
5325	2210506733	E452P2N15011A1K
5326	2210506734	E452P2N15011A1L
5327	2210506735	E452P2N15011A1M
5328	2210506736	E452P2N15011C31
5329	2210506737	E452P2N15011C32
5330	2210506738	E452P2N15011C33
5331	2210506739	E452P2N15011C34
5332	2210506740	E452P2N15011C35
5333	2210506741	E452P2N15011C3A
5334	2210506742	E452P2N15011C3B
5335	2210506743	E452P2N15011C3C
5336	2210506744	E452P2N15011C3D
5337	2210506745	E452P2N15011C3E
5338	2210506746	E452P2N15011C3G
5339	2210506747	E452P2N15011C3H
5340	2210506748	E452P2N15011C3K
5341	2210506749	E452P2N15011C3L
5342	2210506750	E452P2N15011C3M
5343	2210506751	E452P2N15011C41
5344	2210506752	E452P2N15011C42
5345	2210506753	E452P2N15011C43
5346	2210506754	E452P2N15011C44
5347	2210506755	E452P2N15011C45
5348	2210506756	E452P2N15011C4A
5349	2210506757	E452P2N15011C4B
5350	2210506758	E452P2N15011C4C
5351	2210506759	E452P2N15011C4D
5352	2210506760	E452P2N15011C4E
5353	2210506761	E452P2N15011C4G
5354	2210506762	E452P2N15011C4H
5355	2210506763	E452P2N15011C4K
5356	2210506764	E452P2N15011C4L
5357	2210506765	E452P2N15011C4M
5358	2210506770	E452P2N15011E05
5359	2210506785	E452P2N15011R05
5360	2210506796	E452P2N15011R21

Pos.	Molex PN:	Engineering No.:
5361	2210506797	E452P2N15011R22
5362	2210506798	E452P2N15011R23
5363	2210506799	E452P2N15011R24
5364	2210506800	E452P2N15011R25
5365	2210506801	E452P2N15011R2A
5366	2210506802	E452P2N15011R2B
5367	2210506803	E452P2N15011R2C
5368	2210506804	E452P2N15011R2D
5369	2210506805	E452P2N15011R2E
5370	2210506806	E452P2N15011R2G
5371	2210506807	E452P2N15011R2H
5372	2210506808	E452P2N15011R2K
5373	2210506809	E452P2N15011R2L
5374	2210506810	E452P2N15011R2M
5375	2210506811	E452P2N15011S01
5376	2210506812	E452P2N15011S02
5377	2210506813	E452P2N15011S03
5378	2210506814	E452P2N15011S04
5379	2210506815	E452P2N15011S05
5380	2210506816	E452P2N15011S0A
5381	2210506817	E452P2N15011S0B
5382	2210506818	E452P2N15011S0C
5383	2210506819	E452P2N15011S0D
5384	2210506820	E452P2N15011S0E
5385	2210506821	E452P2N15011S0G
5386	2210506822	E452P2N15011S0H
5387	2210506823	E452P2N15011S0K
5388	2210506824	E452P2N15011S0L
5389	2210506825	E452P2N15011S0M
5390	2210506826	E452P2N20011000
5391	2210506827	E452P2N20011A11
5392	2210506828	E452P2N20011A13
5393	2210506829	E452P2N20011A14
5394	2210506830	E452P2N20011A15
5395	2210506831	E452P2N20011A1A
5396	2210506832	E452P2N20011A1B
5397	2210506833	E452P2N20011A1C
5398	2210506834	E452P2N20011A1D
5399	2210506835	E452P2N20011A1E
5400	2210506836	E452P2N20011A1G

Pos.	Molex PN:	Engineering No.:
5401	2210506837	E452P2N20011A1H
5402	2210506838	E452P2N20011A1K
5403	2210506839	E452P2N20011A1L
5404	2210506840	E452P2N20011A1M
5405	2210506841	E452P2N20011C31
5406	2210506842	E452P2N20011C32
5407	2210506843	E452P2N20011C33
5408	2210506844	E452P2N20011C34
5409	2210506845	E452P2N20011C35
5410	2210506846	E452P2N20011C3A
5411	2210506847	E452P2N20011C3C
5412	2210506848	E452P2N20011C3D
5413	2210506849	E452P2N20011C3E
5414	2210506850	E452P2N20011C3G
5415	2210506851	E452P2N20011C3H
5416	2210506852	E452P2N20011C3K
5417	2210506853	E452P2N20011C3L
5418	2210506854	E452P2N20011C3M
5419	2210506855	E452P2N20011C41
5420	2210506856	E452P2N20011C43
5421	2210506857	E452P2N20011C44
5422	2210506858	E452P2N20011C45
5423	2210506859	E452P2N20011C4A
5424	2210506860	E452P2N20011C4B
5425	2210506861	E452P2N20011C4C
5426	2210506862	E452P2N20011C4D
5427	2210506863	E452P2N20011C4E
5428	2210506864	E452P2N20011C4G
5429	2210506865	E452P2N20011C4K
5430	2210506866	E452P2N20011C4L
5431	2210506867	E452P2N20011C4M
5432	2210506872	E452P2N20011E05
5433	2210506887	E452P2N20011R05
5434	2210506898	E452P2N20011R21
5435	2210506899	E452P2N20011R22
5436	2210506900	E452P2N20011R23
5437	2210506901	E452P2N20011R24
5438	2210506902	E452P2N20011R25
5439	2210506903	E452P2N20011R2A
5440	2210506904	E452P2N20011R2B



THIS DRAWING CONTAINS INFORMATION THAT IS PROPRIETARY TO MOLEX ELECTRONIC TECHNOLOGIES, LLC AND SHOULD NOT BE USED WITHOUT WRITTEN PERMISSION									
DIMENSION UNITS		SCALE		CURRENT REV DESC: REVISION CREATED FOR REMOVING PRE-RELEASE STAMP				 E452XXXXXXXXXX DIN FORM A EN 175301-803	
mm		NTS							
GENERAL TOLERANCES (UNLESS SPECIFIED)									
		MM		INCH					
4 PLACES		±		±					
3 PLACES		±		±					
2 PLACES		±		±					
1 PLACE		±		±					
0 PLACES		±		±					
ANGULAR TOL		± °							
DRAFT WHERE APPLICABLE MUST REMAIN WITHIN DIMENSIONS				FIRST ANGLE PROJECTION		DRAWING		SERIES	
						A3-SIZE		121050	
DOCUMENT STATUS		P1		RELEASE DATE		2022/07/19		09:04:35	
		9		8		7		6	
		5		4		3		2	
		1							

TABLE 3 - PART LIST

Pos.	Molex PN:	Engineering No.:
5441	2210506905	E452P2N20011R2C
5442	2210506906	E452P2N20011R2D
5443	2210506907	E452P2N20011R2E
5444	2210506908	E452P2N20011R2G
5445	2210506909	E452P2N20011R2H
5446	2210506910	E452P2N20011R2K
5447	2210506911	E452P2N20011R2L
5448	2210506912	E452P2N20011R2M
5449	2210506913	E452P2N20011S01
5450	2210506914	E452P2N20011S02
5451	2210506915	E452P2N20011S03
5452	2210506916	E452P2N20011S04
5453	2210506917	E452P2N20011S05
5454	2210506918	E452P2N20011S0A
5455	2210506919	E452P2N20011S0C
5456	2210506920	E452P2N20011S0D
5457	2210506921	E452P2N20011S0E
5458	2210506922	E452P2N20011S0G
5459	2210506923	E452P2N20011S0H
5460	2210506924	E452P2N20011S0K
5461	2210506925	E452P2N20011S0L
5462	2210506926	E452P2N20011S0M
5463	2210506927	E452P2N30011000
5464	2210506928	E452P2N30011A11
5465	2210506929	E452P2N30011A12
5466	2210506930	E452P2N30011A13
5467	2210506931	E452P2N30011A14
5468	2210506932	E452P2N30011A15
5469	2210506933	E452P2N30011A1A
5470	2210506934	E452P2N30011A1B
5471	2210506935	E452P2N30011A1C
5472	2210506936	E452P2N30011A1D
5473	2210506937	E452P2N30011A1E
5474	2210506938	E452P2N30011A1G
5475	2210506939	E452P2N30011A1H
5476	2210506940	E452P2N30011A1K
5477	2210506941	E452P2N30011A1L
5478	2210506942	E452P2N30011A1M
5479	2210506943	E452P2N30011C31
5480	2210506944	E452P2N30011C32

Pos.	Molex PN:	Engineering No.:
5481	2210506945	E452P2N30011C33
5482	2210506946	E452P2N30011C34
5483	2210506947	E452P2N30011C35
5484	2210506948	E452P2N30011C3A
5485	2210506949	E452P2N30011C3B
5486	2210506950	E452P2N30011C3C
5487	2210506951	E452P2N30011C3D
5488	2210506952	E452P2N30011C3E
5489	2210506953	E452P2N30011C3G
5490	2210506954	E452P2N30011C3H
5491	2210506955	E452P2N30011C3K
5492	2210506956	E452P2N30011C3L
5493	2210506957	E452P2N30011C3M
5494	2210506958	E452P2N30011C41
5495	2210506959	E452P2N30011C42
5496	2210506960	E452P2N30011C43
5497	2210506961	E452P2N30011C44
5498	2210506962	E452P2N30011C45
5499	2210506963	E452P2N30011C4A
5500	2210506964	E452P2N30011C4B
5501	2210506965	E452P2N30011C4C
5502	2210506966	E452P2N30011C4D
5503	2210506967	E452P2N30011C4E
5504	2210506968	E452P2N30011C4G
5505	2210506969	E452P2N30011C4K
5506	2210506970	E452P2N30011C4M
5507	2210506975	E452P2N30011E05
5508	2210506990	E452P2N30011R05
5509	2210507001	E452P2N30011R21
5510	2210507002	E452P2N30011R22
5511	2210507003	E452P2N30011R23
5512	2210507004	E452P2N30011R24
5513	2210507005	E452P2N30011R25
5514	2210507006	E452P2N30011R2A
5515	2210507007	E452P2N30011R2B
5516	2210507008	E452P2N30011R2C
5517	2210507009	E452P2N30011R2D
5518	2210507010	E452P2N30011R2E
5519	2210507011	E452P2N30011R2G
5520	2210507012	E452P2N30011R2H

Pos.	Molex PN:	Engineering No.:
5521	2210507013	E452P2N30011R2K
5522	2210507014	E452P2N30011R2L
5523	2210507015	E452P2N30011R2M
5524	2210507016	E452P2N30011S01
5525	2210507017	E452P2N30011S02
5526	2210507018	E452P2N30011S03
5527	2210507019	E452P2N30011S04
5528	2210507020	E452P2N30011S05
5529	2210507021	E452P2N30011S0A
5530	2210507022	E452P2N30011S0B
5531	2210507023	E452P2N30011S0C
5532	2210507024	E452P2N30011S0D
5533	2210507025	E452P2N30011S0E
5534	2210507026	E452P2N30011S0G
5535	2210507027	E452P2N30011S0K
5536	2210507028	E452P2N30011S0L
5537	2210507029	E452P2N30011S0M
5538	2210507030	E452P2N50011000
5539	2210507031	E452P2N50011A11
5540	2210507032	E452P2N50011A12
5541	2210507033	E452P2N50011A13
5542	2210507034	E452P2N50011A14
5543	2210507035	E452P2N50011A15
5544	2210507036	E452P2N50011A1A
5545	2210507037	E452P2N50011A1B
5546	2210507038	E452P2N50011A1C
5547	2210507039	E452P2N50011A1D
5548	2210507040	E452P2N50011A1E
5549	2210507041	E452P2N50011A1G
5550	2210507042	E452P2N50011A1H
5551	2210507043	E452P2N50011A1K
5552	2210507044	E452P2N50011A1L
5553	2210507045	E452P2N50011A1M
5554	2210507046	E452P2N50011C31
5555	2210507047	E452P2N50011C32
5556	2210507048	E452P2N50011C33
5557	2210507049	E452P2N50011C34
5558	2210507050	E452P2N50011C35
5559	2210507051	E452P2N50011C3A
5560	2210507052	E452P2N50011C3B

Pos.	Molex PN:	Engineering No.:
5561	2210507053	E452P2N50011C3C
5562	2210507054	E452P2N50011C3D
5563	2210507055	E452P2N50011C3E
5564	2210507056	E452P2N50011C3G
5565	2210507057	E452P2N50011C3H
5566	2210507058	E452P2N50011C3K
5567	2210507059	E452P2N50011C3L
5568	2210507060	E452P2N50011C3M
5569	2210507061	E452P2N50011C41
5570	2210507062	E452P2N50011C43
5571	2210507063	E452P2N50011C44
5572	2210507064	E452P2N50011C45
5573	2210507065	E452P2N50011C4A
5574	2210507066	E452P2N50011C4C
5575	2210507067	E452P2N50011C4D
5576	2210507068	E452P2N50011C4E
5577	2210507069	E452P2N50011C4K
5578	2210507074	E452P2N50011E05
5579	2210507089	E452P2N50011R05
5580	2210507100	E452P2N50011R21
5581	2210507101	E452P2N50011R22
5582	2210507102	E452P2N50011R23
5583	2210507103	E452P2N50011R24
5584	2210507104	E452P2N50011R25
5585	2210507105	E452P2N50011R2A
5586	2210507106	E452P2N50011R2B
5587	2210507107	E452P2N50011R2C
5588	2210507108	E452P2N50011R2D
5589	2210507109	E452P2N50011R2E
5590	2210507110	E452P2N50011R2G
5591	2210507111	E452P2N50011R2H
5592	2210507112	E452P2N50011R2K
5593	2210507113	E452P2N50011R2L
5594	2210507114	E452P2N50011R2M
5595	2210507115	E452P2N50011S01
5596	2210507116	E452P2N50011S02
5597	2210507117	E452P2N50011S03
5598	2210507118	E452P2N50011S04
5599	2210507119	E452P2N50011S05
5600	2210507120	E452P2N50011S0A

THIS DRAWING CONTAINS INFORMATION THAT IS PROPRIETARY TO MOLEX ELECTRONIC TECHNOLOGIES, LLC AND SHOULD NOT BE USED WITHOUT WRITTEN PERMISSION									
DIMENSION UNITS		SCALE		CURRENT REV DESC: REVISION CREATED FOR REMOVING PRE-RELEASE STAMP				 E452XXXXXXXXXX DIN FORM A EN 175301-803	
mm		NTS							
GENERAL TOLERANCES (UNLESS SPECIFIED)				EC NO: 714567		2022/07/18		PRODUCT CUSTOMER DRAWING	
				DRWN: SUGEEB		2022/07/19			
				CHK'D: GGA		2022/07/19		DOCUMENT NUMBER	
				APPR: GGA		2022/07/19			
				INITIAL REVISION:				SD-121050-001	
				DRWN: JMARSZALEK		2012/08/27			
				APPR: MDYSZEWSKA		2012/08/20		DOC TYPE	
				ANGULAR TOL				PSD	
				DRAFT WHERE APPLICABLE MUST REMAIN WITHIN DIMENSIONS		FIRST ANGLE PROJECTION		DOC PART	
						DRAWING		001	
						SERIES		REVISION	
						A3-SIZE		E1	
						121050			
						MATERIAL NUMBER			
						CUSTOMER			
						SEE TABLE			
						GENERAL MARKET			
								SHEET NUMBER	
								38 OF 41	

TABLE 3 - PART LIST

Pos.	Molex PN:	Engineering No.:
5601	2210507121	E452P2N50011S0B
5602	2210507122	E452P2N50011S0C
5603	2210507123	E452P2N50011S0D
5604	2210507124	E452P2N50011S0E
5605	2210507125	E452P2N50011S0G
5606	2210507126	E452P2N50011S0K
5607	2210507127	E452P2N50011S0L
5608	2210507128	E452P2N50011S0M
5609	2210507129	E452P3N10011000
5610	2210507130	E452P3N10011A11
5611	2210507131	E452P3N10011A12
5612	2210507132	E452P3N10011A13
5613	2210507133	E452P3N10011A14
5614	2210507134	E452P3N10011A15
5615	2210507135	E452P3N10011A1A
5616	2210507136	E452P3N10011A1B
5617	2210507137	E452P3N10011A1C
5618	2210507138	E452P3N10011A1D
5619	2210507139	E452P3N10011A1E
5620	2210507140	E452P3N10011A1G
5621	2210507141	E452P3N10011A1H
5622	2210507142	E452P3N10011A1K
5623	2210507143	E452P3N10011A1L
5624	2210507144	E452P3N10011A1M
5625	2210507145	E452P3N10011C31
5626	2210507146	E452P3N10011C32
5627	2210507147	E452P3N10011C33
5628	2210507148	E452P3N10011C34
5629	2210507149	E452P3N10011C35
5630	2210507150	E452P3N10011C3A
5631	2210507151	E452P3N10011C3B
5632	2210507152	E452P3N10011C3C
5633	2210507153	E452P3N10011C3D
5634	2210507154	E452P3N10011C3E
5635	2210507155	E452P3N10011C3G
5636	2210507156	E452P3N10011C3H
5637	2210507157	E452P3N10011C3K
5638	2210507158	E452P3N10011C3L
5639	2210507159	E452P3N10011C3M
5640	2210507160	E452P3N10011C41

Pos.	Molex PN:	Engineering No.:
5641	2210507161	E452P3N10011C42
5642	2210507162	E452P3N10011C43
5643	2210507163	E452P3N10011C44
5644	2210507164	E452P3N10011C45
5645	2210507165	E452P3N10011C4A
5646	2210507166	E452P3N10011C4B
5647	2210507167	E452P3N10011C4C
5648	2210507168	E452P3N10011C4D
5649	2210507169	E452P3N10011C4E
5650	2210507170	E452P3N10011C4G
5651	2210507171	E452P3N10011C4K
5652	2210507172	E452P3N10011C4M
5653	2210507177	E452P3N10011E05
5654	2210507192	E452P3N10011R05
5655	2210507203	E452P3N10011R21
5656	2210507204	E452P3N10011R22
5657	2210507205	E452P3N10011R23
5658	2210507206	E452P3N10011R24
5659	2210507207	E452P3N10011R25
5660	2210507208	E452P3N10011R2A
5661	2210507209	E452P3N10011R2C
5662	2210507210	E452P3N10011R2D
5663	2210507211	E452P3N10011R2G
5664	2210507212	E452P3N10011R2H
5665	2210507213	E452P3N10011R2K
5666	2210507214	E452P3N10011R2L
5667	2210507215	E452P3N10011R2M
5668	2210507216	E452P3N10011S01
5669	2210507217	E452P3N10011S02
5670	2210507218	E452P3N10011S03
5671	2210507219	E452P3N10011S04
5672	2210507220	E452P3N10011S05
5673	2210507221	E452P3N10011S0A
5674	2210507222	E452P3N10011S0B
5675	2210507223	E452P3N10011S0C
5676	2210507224	E452P3N10011S0D
5677	2210507225	E452P3N10011S0E
5678	2210507226	E452P3N10011S0G
5679	2210507227	E452P3N10011S0H
5680	2210507228	E452P3N10011S0K

Pos.	Molex PN:	Engineering No.:
5681	2210507229	E452P3N10011S0L
5682	2210507230	E452P3N10011S0M
5683	2210507231	E452P3N10K11000
5684	2210507232	E452P3N10K11A11
5685	2210507233	E452P3N10K11A12
5686	2210507234	E452P3N10K11A13
5687	2210507235	E452P3N10K11A14
5688	2210507236	E452P3N10K11A15
5689	2210507237	E452P3N10K11A1A
5690	2210507238	E452P3N10K11A1B
5691	2210507239	E452P3N10K11A1C
5692	2210507240	E452P3N10K11A1D
5693	2210507241	E452P3N10K11A1E
5694	2210507242	E452P3N10K11A1G
5695	2210507243	E452P3N10K11A1H
5696	2210507244	E452P3N10K11A1K
5697	2210507245	E452P3N10K11A1L
5698	2210507246	E452P3N10K11A1M
5699	2210507247	E452P3N10K11C31
5700	2210507248	E452P3N10K11C32
5701	2210507249	E452P3N10K11C33
5702	2210507250	E452P3N10K11C34
5703	2210507251	E452P3N10K11C35
5704	2210507252	E452P3N10K11C3A
5705	2210507253	E452P3N10K11C3B
5706	2210507254	E452P3N10K11C3C
5707	2210507255	E452P3N10K11C3D
5708	2210507256	E452P3N10K11C3E
5709	2210507257	E452P3N10K11C3G
5710	2210507258	E452P3N10K11C3H
5711	2210507259	E452P3N10K11C3K
5712	2210507260	E452P3N10K11C3L
5713	2210507261	E452P3N10K11C3M
5714	2210507262	E452P3N10K11C41
5715	2210507263	E452P3N10K11C42
5716	2210507264	E452P3N10K11C43
5717	2210507265	E452P3N10K11C44
5718	2210507266	E452P3N10K11C45
5719	2210507267	E452P3N10K11C4A
5720	2210507268	E452P3N10K11C4B

Pos.	Molex PN:	Engineering No.:
5721	2210507269	E452P3N10K11C4C
5722	2210507270	E452P3N10K11C4D
5723	2210507271	E452P3N10K11C4E
5724	2210507272	E452P3N10K11C4G
5725	2210507273	E452P3N10K11C4K
5726	2210507274	E452P3N10K11C4L
5727	2210507275	E452P3N10K11C4M
5728	2210507280	E452P3N10K11E05
5729	2210507295	E452P3N10K11R05
5730	2210507306	E452P3N10K11R21
5731	2210507307	E452P3N10K11R22
5732	2210507308	E452P3N10K11R23
5733	2210507309	E452P3N10K11R24
5734	2210507310	E452P3N10K11R25
5735	2210507311	E452P3N10K11R2A
5736	2210507312	E452P3N10K11R2B
5737	2210507313	E452P3N10K11R2C
5738	2210507314	E452P3N10K11R2D
5739	2210507315	E452P3N10K11R2E
5740	2210507316	E452P3N10K11R2G
5741	2210507317	E452P3N10K11R2H
5742	2210507318	E452P3N10K11R2K
5743	2210507319	E452P3N10K11R2L
5744	2210507320	E452P3N10K11R2M
5745	2210507321	E452P3N10K11S01
5746	2210507322	E452P3N10K11S02
5747	2210507323	E452P3N10K11S03
5748	2210507324	E452P3N10K11S04
5749	2210507325	E452P3N10K11S05
5750	2210507326	E452P3N10K11S0A
5751	2210507327	E452P3N10K11S0B
5752	2210507328	E452P3N10K11S0C
5753	2210507329	E452P3N10K11S0D
5754	2210507330	E452P3N10K11S0E
5755	2210507331	E452P3N10K11S0G
5756	2210507332	E452P3N10K11S0K
5757	2210507333	E452P3N10K11S0L
5758	2210507334	E452P3N10K11S0M
5759	2210507335	E452P3N15011000
5760	2210507336	E452P3N15011A11

THIS DRAWING CONTAINS INFORMATION THAT IS PROPRIETARY TO MOLEX ELECTRONIC TECHNOLOGIES, LLC AND SHOULD NOT BE USED WITHOUT WRITTEN PERMISSION									
DIMENSION UNITS		SCALE		CURRENT REV DESC: REVISION CREATED FOR REMOVING PRE-RELEASE STAMP				 E452XXXXXXXXXX DIN FORM A EN 175301-803	
mm		NTS							
GENERAL TOLERANCES (UNLESS SPECIFIED)				EC NO: 714567		2022/07/18		PRODUCT CUSTOMER DRAWING	
				DRWN: SUGEEB		2022/07/19			
				CHK'D: GGA		2022/07/19		DOCUMENT NUMBER	
				APPR: GGA		2022/07/19			
				INITIAL REVISION:				SD-121050-001	
				DRWN: JMARSZALEK		2012/08/27			
				APPR: MDYSZEWSKA		2012/08/20		DOC TYPE	
				ANGULAR TOL				DOC PART	
				DRAFT WHERE APPLICABLE MUST REMAIN WITHIN DIMENSIONS		FIRST ANGLE PROJECTION		REVISION	
						DRAWING		PSD	
						SERIES		001	
						MATERIAL NUMBER		E1	
						CUSTOMER		39 OF 41	
						SEE TABLE			
						GENERAL MARKET			

TABLE 3 - PART LIST

Pos.	Molex PN:	Engineering No.:
5761	2210507337	E452P3N15011A12
5762	2210507338	E452P3N15011A13
5763	2210507339	E452P3N15011A14
5764	2210507340	E452P3N15011A15
5765	2210507341	E452P3N15011A1A
5766	2210507342	E452P3N15011A1B
5767	2210507343	E452P3N15011A1C
5768	2210507344	E452P3N15011A1D
5769	2210507345	E452P3N15011A1E
5770	2210507346	E452P3N15011A1G
5771	2210507347	E452P3N15011A1H
5772	2210507348	E452P3N15011A1K
5773	2210507349	E452P3N15011A1L
5774	2210507350	E452P3N15011A1M
5775	2210507351	E452P3N15011C31
5776	2210507352	E452P3N15011C32
5777	2210507353	E452P3N15011C33
5778	2210507354	E452P3N15011C34
5779	2210507355	E452P3N15011C35
5780	2210507356	E452P3N15011C3A
5781	2210507357	E452P3N15011C3B
5782	2210507358	E452P3N15011C3C
5783	2210507359	E452P3N15011C3D
5784	2210507360	E452P3N15011C3E
5785	2210507361	E452P3N15011C3G
5786	2210507362	E452P3N15011C3H
5787	2210507363	E452P3N15011C3K
5788	2210507364	E452P3N15011C3L
5789	2210507365	E452P3N15011C3M
5790	2210507366	E452P3N15011C41
5791	2210507367	E452P3N15011C42
5792	2210507368	E452P3N15011C43
5793	2210507369	E452P3N15011C44
5794	2210507370	E452P3N15011C45
5795	2210507371	E452P3N15011C4A
5796	2210507372	E452P3N15011C4B
5797	2210507373	E452P3N15011C4C
5798	2210507374	E452P3N15011C4D
5799	2210507375	E452P3N15011C4E
5800	2210507376	E452P3N15011C4G

Pos.	Molex PN:	Engineering No.:
5801	2210507377	E452P3N15011C4H
5802	2210507378	E452P3N15011C4K
5803	2210507379	E452P3N15011C4L
5804	2210507380	E452P3N15011C4M
5805	2210507385	E452P3N15011E05
5806	2210507400	E452P3N15011R05
5807	2210507411	E452P3N15011R21
5808	2210507412	E452P3N15011R22
5809	2210507413	E452P3N15011R23
5810	2210507414	E452P3N15011R24
5811	2210507415	E452P3N15011R25
5812	2210507416	E452P3N15011R2A
5813	2210507417	E452P3N15011R2B
5814	2210507418	E452P3N15011R2C
5815	2210507419	E452P3N15011R2D
5816	2210507420	E452P3N15011R2E
5817	2210507421	E452P3N15011R2G
5818	2210507422	E452P3N15011R2H
5819	2210507423	E452P3N15011R2K
5820	2210507424	E452P3N15011R2L
5821	2210507425	E452P3N15011R2M
5822	2210507426	E452P3N15011S01
5823	2210507427	E452P3N15011S02
5824	2210507428	E452P3N15011S03
5825	2210507429	E452P3N15011S04
5826	2210507430	E452P3N15011S05
5827	2210507431	E452P3N15011S0A
5828	2210507432	E452P3N15011S0B
5829	2210507433	E452P3N15011S0C
5830	2210507434	E452P3N15011S0D
5831	2210507435	E452P3N15011S0E
5832	2210507436	E452P3N15011S0G
5833	2210507437	E452P3N15011S0K
5834	2210507438	E452P3N15011S0L
5835	2210507439	E452P3N15011S0M
5836	2210507440	E452P3N20011000
5837	2210507441	E452P3N20011A11
5838	2210507442	E452P3N20011A12
5839	2210507443	E452P3N20011A13
5840	2210507444	E452P3N20011A14

Pos.	Molex PN:	Engineering No.:
5841	2210507445	E452P3N20011A15
5842	2210507446	E452P3N20011A1A
5843	2210507447	E452P3N20011A1B
5844	2210507448	E452P3N20011A1C
5845	2210507449	E452P3N20011A1D
5846	2210507450	E452P3N20011A1E
5847	2210507451	E452P3N20011A1G
5848	2210507452	E452P3N20011A1H
5849	2210507453	E452P3N20011A1K
5850	2210507454	E452P3N20011A1L
5851	2210507455	E452P3N20011A1M
5852	2210507456	E452P3N20011C31
5853	2210507457	E452P3N20011C32
5854	2210507458	E452P3N20011C33
5855	2210507459	E452P3N20011C34
5856	2210507460	E452P3N20011C35
5857	2210507461	E452P3N20011C3A
5858	2210507462	E452P3N20011C3B
5859	2210507463	E452P3N20011C3C
5860	2210507464	E452P3N20011C3D
5861	2210507465	E452P3N20011C3E
5862	2210507466	E452P3N20011C3G
5863	2210507467	E452P3N20011C3H
5864	2210507468	E452P3N20011C3K
5865	2210507469	E452P3N20011C3L
5866	2210507470	E452P3N20011C3M
5867	2210507471	E452P3N20011C41
5868	2210507472	E452P3N20011C43
5869	2210507473	E452P3N20011C45
5870	2210507474	E452P3N20011C4A
5871	2210507475	E452P3N20011C4B
5872	2210507476	E452P3N20011C4C
5873	2210507477	E452P3N20011C4D
5874	2210507478	E452P3N20011C4E
5875	2210507479	E452P3N20011C4G
5876	2210507480	E452P3N20011C4H
5877	2210507481	E452P3N20011C4K
5878	2210507482	E452P3N20011C4M
5879	2210507487	E452P3N20011E05
5880	2210507502	E452P3N20011R05

Pos.	Molex PN:	Engineering No.:
5881	2210507513	E452P3N20011R21
5882	2210507514	E452P3N20011R22
5883	2210507515	E452P3N20011R23
5884	2210507516	E452P3N20011R24
5885	2210507517	E452P3N20011R25
5886	2210507518	E452P3N20011R2A
5887	2210507519	E452P3N20011R2B
5888	2210507520	E452P3N20011R2C
5889	2210507521	E452P3N20011R2D
5890	2210507522	E452P3N20011R2E
5891	2210507523	E452P3N20011R2G
5892	2210507524	E452P3N20011R2H
5893	2210507525	E452P3N20011R2K
5894	2210507526	E452P3N20011R2L
5895	2210507527	E452P3N20011R2M
5896	2210507528	E452P3N20011S01
5897	2210507529	E452P3N20011S03
5898	2210507530	E452P3N20011S04
5899	2210507531	E452P3N20011S05
5900	2210507532	E452P3N20011S0A
5901	2210507533	E452P3N20011S0B
5902	2210507534	E452P3N20011S0C
5903	2210507535	E452P3N20011S0D
5904	2210507536	E452P3N20011S0E
5905	2210507537	E452P3N20011S0G
5906	2210507538	E452P3N20011S0H
5907	2210507539	E452P3N20011S0K
5908	2210507540	E452P3N20011S0L
5909	2210507541	E452P3N20011S0M
5910	2210507542	E452P3N30011000
5911	2210507543	E452P3N30011A11
5912	2210507544	E452P3N30011A12
5913	2210507545	E452P3N30011A13
5914	2210507546	E452P3N30011A14
5915	2210507547	E452P3N30011A15
5916	2210507548	E452P3N30011A1A
5917	2210507549	E452P3N30011A1B
5918	2210507550	E452P3N30011A1C
5919	2210507551	E452P3N30011A1D
5920	2210507552	E452P3N30011A1E

THIS DRAWING CONTAINS INFORMATION THAT IS PROPRIETARY TO MOLEX ELECTRONIC TECHNOLOGIES, LLC AND SHOULD NOT BE USED WITHOUT WRITTEN PERMISSION									
DIMENSION UNITS		SCALE		CURRENT REV DESC: REVISION CREATED FOR REMOVING PRE-RELEASE STAMP				 E452XXXXXXXXXX DIN FORM A EN 175301-803	
mm		NTS							
GENERAL TOLERANCES (UNLESS SPECIFIED)									
		MM		INCH					
4 PLACES		±		±					
3 PLACES		±		±					
2 PLACES		±		±					
1 PLACE		±		±					
0 PLACES		±		±					
ANGULAR TOL		± °							
DRAFT WHERE APPLICABLE MUST REMAIN WITHIN DIMENSIONS				FIRST ANGLE PROJECTION		DRAWING		SERIES	
						A3-SIZE		121050	
DOCUMENT STATUS		P1		RELEASE DATE		2022/07/19		09:04:35	
DOCUMENT NUMBER		SD-121050-001		DOC TYPE		PSD		DOC PART	
REVISION		001		REVISION		E1		SHEET NUMBER	
MATERIAL NUMBER		SEE TABLE		CUSTOMER		GENERAL MARKET		40 OF 41	

TABLE 3 - PART LIST

Pos.	Molex PN:	Engineering No.:
5921	2210507553	E452P3N30011A1G
5922	2210507554	E452P3N30011A1H
5923	2210507555	E452P3N30011A1K
5924	2210507556	E452P3N30011A1L
5925	2210507557	E452P3N30011A1M
5926	2210507558	E452P3N30011C31
5927	2210507559	E452P3N30011C32
5928	2210507560	E452P3N30011C33
5929	2210507561	E452P3N30011C34
5930	2210507562	E452P3N30011C35
5931	2210507563	E452P3N30011C3A
5932	2210507564	E452P3N30011C3B
5933	2210507565	E452P3N30011C3C
5934	2210507566	E452P3N30011C3D
5935	2210507567	E452P3N30011C3E
5936	2210507568	E452P3N30011C3G
5937	2210507569	E452P3N30011C3K
5938	2210507570	E452P3N30011C3L
5939	2210507571	E452P3N30011C3M
5940	2210507572	E452P3N30011C41
5941	2210507573	E452P3N30011C42
5942	2210507574	E452P3N30011C43
5943	2210507575	E452P3N30011C44
5944	2210507576	E452P3N30011C45
5945	2210507577	E452P3N30011C4A
5946	2210507578	E452P3N30011C4B
5947	2210507579	E452P3N30011C4C
5948	2210507580	E452P3N30011C4D
5949	2210507581	E452P3N30011C4E
5950	2210507582	E452P3N30011C4G
5951	2210507583	E452P3N30011C4K
5952	N/A	N/A
5953	2210507589	E452P3N30011E05
5954	2210507604	E452P3N30011R05
5955	2210507615	E452P3N30011R21
5956	2210507616	E452P3N30011R22
5957	2210507617	E452P3N30011R23
5958	2210507618	E452P3N30011R24
5959	2210507619	E452P3N30011R25
5960	2210507620	E452P3N30011R2A

Pos.	Molex PN:	Engineering No.:
5961	2210507621	E452P3N30011R2B
5962	2210507622	E452P3N30011R2C
5963	2210507623	E452P3N30011R2D
5964	2210507624	E452P3N30011R2E
5965	2210507625	E452P3N30011R2G
5966	2210507626	E452P3N30011R2H
5967	2210507627	E452P3N30011R2K
5968	2210507628	E452P3N30011R2L
5969	2210507629	E452P3N30011R2M
5970	2210507630	E452P3N30011S01
5971	2210507631	E452P3N30011S02
5972	2210507632	E452P3N30011S03
5973	2210507633	E452P3N30011S04
5974	2210507634	E452P3N30011S05
5975	2210507635	E452P3N30011S0A
5976	2210507636	E452P3N30011S0C
5977	2210507637	E452P3N30011S0D
5978	2210507638	E452P3N30011S0E
5979	2210507639	E452P3N30011S0G
5980	2210507640	E452P3N30011S0K
5981	2210507641	E452P3N30011S0L
5982	2210507642	E452P3N30011S0M
5983	2210507643	E452P3N50011000
5984	2210507644	E452P3N50011A11
5985	2210507645	E452P3N50011A12
5986	2210507646	E452P3N50011A13
5987	2210507647	E452P3N50011A14
5988	2210507648	E452P3N50011A15
5989	2210507649	E452P3N50011A1A
5990	2210507650	E452P3N50011A1B
5991	2210507651	E452P3N50011A1C
5992	2210507652	E452P3N50011A1D
5993	2210507653	E452P3N50011A1E
5994	2210507654	E452P3N50011A1G
5995	2210507655	E452P3N50011A1K
5996	2210507656	E452P3N50011A1L
5997	2210507657	E452P3N50011A1M
5998	2210507658	E452P3N50011C31
5999	2210507659	E452P3N50011C32
6000	2210507660	E452P3N50011C33

Pos.	Molex PN:	Engineering No.:
6001	2210507661	E452P3N50011C34
6002	2210507662	E452P3N50011C35
6003	2210507663	E452P3N50011C3A
6004	2210507664	E452P3N50011C3B
6005	2210507665	E452P3N50011C3C
6006	2210507666	E452P3N50011C3D
6007	2210507667	E452P3N50011C3E
6008	2210507668	E452P3N50011C3G
6009	2210507669	E452P3N50011C3K
6010	2210507670	E452P3N50011C3L
6011	2210507671	E452P3N50011C3M
6012	2210507672	E452P3N50011C41
6013	2210507673	E452P3N50011C42
6014	2210507674	E452P3N50011C43
6015	2210507675	E452P3N50011C45
6016	2210507676	E452P3N50011C4A
6017	2210507677	E452P3N50011C4B
6018	2210507678	E452P3N50011C4C
6019	2210507679	E452P3N50011C4D
6020	2210507680	E452P3N50011C4E
6021	2210507681	E452P3N50011C4G
6022	2210507682	E452P3N50011C4K
6023	2210507683	E452P3N50011C4L
6024	2210507688	E452P3N50011E05
6025	2210507703	E452P3N50011R05
6026	2210507714	E452P3N50011R21
6027	2210507715	E452P3N50011R22
6028	2210507716	E452P3N50011R23
6029	2210507717	E452P3N50011R24
6030	2210507718	E452P3N50011R25
6031	2210507719	E452P3N50011R2A
6032	2210507720	E452P3N50011R2B
6033	2210507721	E452P3N50011R2C
6034	2210507722	E452P3N50011R2D
6035	2210507723	E452P3N50011R2G
6036	2210507724	E452P3N50011R2H
6037	2210507725	E452P3N50011R2K
6038	2210507726	E452P3N50011R2L
6039	2210507727	E452P3N50011R2M
6040	2210507728	E452P3N50011S01

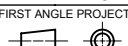
Pos.	Molex PN:	Engineering No.:
6041	2210507729	E452P3N50011S03
6042	2210507730	E452P3N50011S04
6043	2210507731	E452P3N50011S05
6044	2210507732	E452P3N50011S0A
6045	2210507733	E452P3N50011S0C
6046	2210507734	E452P3N50011S0D
6047	2210507735	E452P3N50011S0E
6048	2210507736	E452P3N50011S0G
6049	2210507737	E452P3N50011S0K
6050	2210507738	E452P3N50011S0L
6051	2210507739	E452P3N50011S0M
6052	1210502457	Q452N3N30011C4H
6053	1210502462	Q452P3N30011C4H
6054	1210502463	Q452P3N50011C4H
6055	1210502464	Q452I4N30011C4H
6056	1210502465	Q452I4N50011C4H
6057		
6058		
6059		
6060		
6061		
6062		
6063		
6064		
6065		
6066		
6067		
6068		
6069		
6070		
6071		
6072		
6073		
6074		
6075		
6076		
6077		
6078		
6079		
6080		

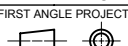
THIS DRAWING CONTAINS INFORMATION THAT IS PROPRIETARY TO MOLEX ELECTRONIC TECHNOLOGIES, LLC AND SHOULD NOT BE USED WITHOUT WRITTEN PERMISSION									
DIMENSION UNITS		SCALE		CURRENT REV DESC: REVISION CREATED FOR REMOVING PRE-RELEASE STAMP					
mm		NTS							
GENERAL TOLERANCES (UNLESS SPECIFIED)									
		MM	INCH						
4 PLACES	±								
3 PLACES	±								
2 PLACES	±								
1 PLACE	±								
0 PLACES	±								
ANGULAR TOL		±	°						
DRAFT WHERE APPLICABLE MUST REMAIN WITHIN DIMENSIONS				FIRST ANGLE PROJECTION		DRAWING		SERIES	
						A3-SIZE		121050	
DOCUMENT STATUS		P1		RELEASE DATE		2022/07/19 09:04:35			