

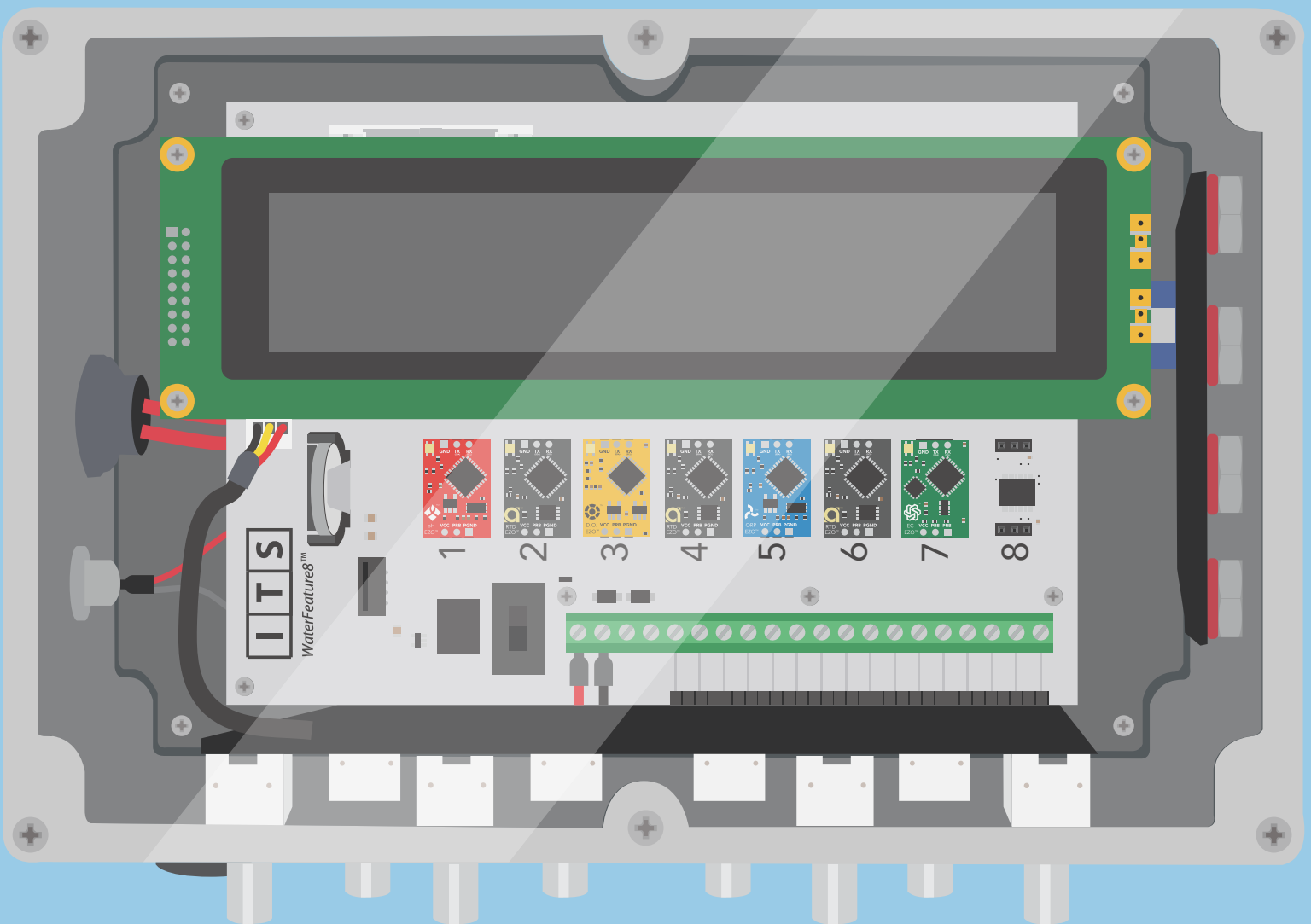

Industrial Monitoring Kit



Integrated Treatment Systems, LLC



*WaterFeature8™
A-Series
Sensor Interface System*

INSTRUCTION MANUAL

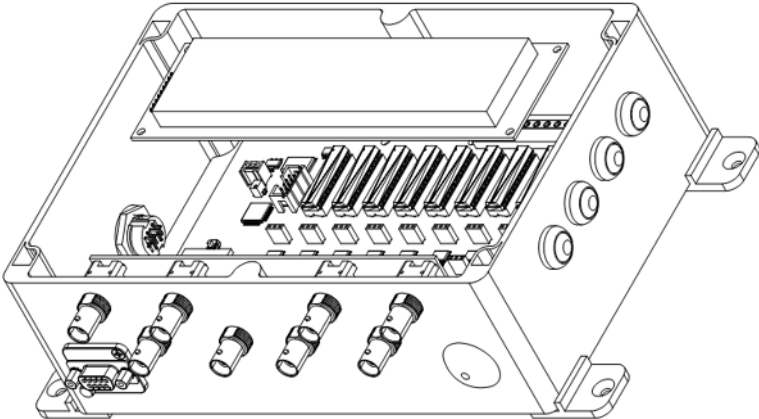

AUGUST 2022

Table of Contents

1 OVERVIEW	3
1.1 Configurations.....	3
1.2 Voltage Isolation.....	3
2 <i>WaterFeature8</i> BOARD COMPONENTS.....	4
3 DEVICE SPECIFICATIONS	5
3.1 Power Consumption.....	6
3.2 Sensor Interface System Enclosure.....	6
4 INSTALLATION	7
4.1 Mounting Dimensions, <i>WaterFeature8</i> Circuit Board.....	7
4.2 Installation Procedure, System Builder Kit.....	7
4.3 Mounting Dimensions, Sensor Interface System.....	8
4.4 Installation Procedure, Sensor Interface System.....	8
4.5 WF-IB Isolation Board Installation	9
5 EZO CIRCUIT SETUP	10
5.1 Automatic Configuration.....	10
5.2 Manual Configuration.....	10
6 STARTING THE <i>WaterFeature8</i>	12
6.3 Temperature Compensation Detection.....	12
6.4 Main Menu/Home Screen	12
7 CALIBRATION INSTRUCTIONS	13
7.1 General Calibration Procedures	13
7.2 EZO Specific Calibration Procedures	13
7.3 Calibration Tips	14
8 TEMPERATURE COMPENSATION	16
8.1 TComp Initiation.....	16
8.2 Channel Target Assignments	16
9 DATA RECORDING	17
9.1 Card Configuration	17
9.2 Recording Setup.....	17
9.3 Data Format.....	17
9.4 Error Codes.....	18
10 REMOTE COMMUNICATIONS	19
10.1 Connecting Remotely	19
10.2 Startup Performance	19
10.3 Remote State Initialization	19
10.4 Remote State Local User Interface.....	19
10.5 Command Definitions	20
10.6 Remote State Best Practices.....	21
11 BILL OF MATERIALS	23
12 <i>WF8</i> VERSION HISTORY & EZO COMPATIBILITY	24
13 GUARANTEE.....	25
13.1 Warranty Statement	25

13.2 Quality Assurance	25
13.3 Design Philosophy	25
13.4 Contact Us	26

1 OVERVIEW

The *WaterFeature8™ (WF8™)* A-series water quality monitoring system is designed and manufactured by Integrated Treatment Systems, LLC (ITS®) to accomplish these objectives:

- Monitor up to eight (8) different water quality monitoring sensors at one time;
- Communicate with off-the-shelf EZO™ circuits manufactured by Atlas Scientific, LLC™ in the United States of America;
- Update and display sensor measurement values while in-situ water parameters change in real-time;
- Communicate remotely over native RS-232 serial communications using a simple, intuitive operating system;
- Store measurement data on removable memory media (TransFlash and microSD);
- Record and retain date and time data;
- *Included on Serial+Analog models:* Output a high resolution 4-20mA current loop to an external data processor such as a Programmable Logic Controller (PLC) and/or Analog Input (AI) card for data retention and process control (PLC and AI card are not included with the *WaterFeature8* System).

The *WaterFeature8* ecosystem is designed specifically for water quality monitoring solutions, and ITS encourages the use of custom-built integrated systems to address a wide range of different water quality challenges. It can be used for observing water parameters as they change in real time, or it can be fully integrated into a PID control loop to provide signaling for use with a Programmable Logic Controller or other industrial control device.

WaterFeature8 systems are proudly designed and assembled by hand in the United States of America from domestic and foreign sourced parts.

1.1 Configurations

The *WaterFeature8* system is available in several different configurations.

- System Builder Kit (SBK)
 - Includes:
 - *WaterFeature8* circuit board,
 - LCD HMI,
 - Pushbuttons,
 - Panel Integration Kit;
 - Part number *WF8.SBK.0420* with 4-20 mA output circuits;
 - Part number *WF8.SBK.0000* without 4-20 mA output circuits.
- Sensor Interface System (SIS)
 - Includes:
 - *WaterFeature8* circuit board,
 - LCD HMI,
 - Pushbuttons,
 - Power supply with wall plug adapter,
 - Fully assembled in a polycarbonate or metal enclosure;

- Part number *WF8.SIS.BNC.P/M.0420* with BNC jack connectors and 4-20 mA output circuits;
- Part number *WF8.SIS.BNC.P/M.0000* with BNC jack connectors and without 4-20 mA output circuits;

Model No.	WF8.SBK.0000	WF8.SBK.0420	WF8.SIS.BNC.P.0000	WF8.SIS.BNC.P.0420	WF8.SIS.BNC.M.0000	WF8.SIS.BNC.M.0420
<i>Panel Integration Kit</i>	Opt.	Opt.	No	No	No	No
<i>Enclosure</i>	None	None	Plastic	Plastic	Metal	Metal
<i>Power Adapter</i>	User Suppl. 24VDC	User Suppl. 24VDC	2-pr Wall Adpt.	2-pr Wall Adpt.	2-pr Wall Adpt.	2-pr Wall Adpt.
<i>Sensor Connector Style</i>	Term.	Term.	BNC Jack	BNC Jack	BNC Jack	BNC Jack
<i>Includes 4-20 mA Outputs</i>	No	Yes	No	Yes	No	Yes

1.2 Voltage Isolation

Voltage isolation is strongly recommended for Dissolved Oxygen (DO), Electroconductivity (EC), Oxidation Reduction Potential (ORP) and pH EZO circuits. Integrated Treatment Systems, LLC manufactures an in-line voltage isolator, specifically designed for the *WaterFeature* line of products, part number WF-IB (sold separately).

The WF-IB is installed between the EZO and the *WaterFeature8* printed circuit board. It provides complete voltage isolation and protection from interference, ground loops, and harmful voltages.

2 WaterFeature8 BOARD COMPONENTS

The *WaterFeature8* is designed specifically to work with Atlas Scientific, LLC EZO sensor interpreting circuits.

The *WaterFeature8* is NOT designed to work with non-Atlas Scientific, LLC or non-ITS circuits. DO NOT ATTEMPT TO INSERT ANY OTHER CIRCUITS INTO THE ONBOARD MOUNTS AS THIS WILL VOID ALL WARRANTIES ASSOCIATED WITH THE *WaterFeature8* PRODUCT.

Certain components are intended to be removable such as the Atlas Scientific, LLC EZO module and the ITS WF-IB voltage isolator. Exercise caution when inserting and removing these devices from the board sockets. Integrated Treatment Systems, LLC does not warrant devices manufactured by others, nor the *WaterFeature8* board, against failure due to excessive insertion or removal stress.

WARNING:

Exercise caution when handling sensitive electronics. Electrostatic Discharge (ESD) may damage EZO circuits and/or the WaterFeature8 board. Take suitable ESD protective measures whenever working with these devices. This may include using ESD mats, grounded wrist straps, and other industry standard ESD precautions. Damage caused by ESD failure will void the WaterFeature8 warranty.

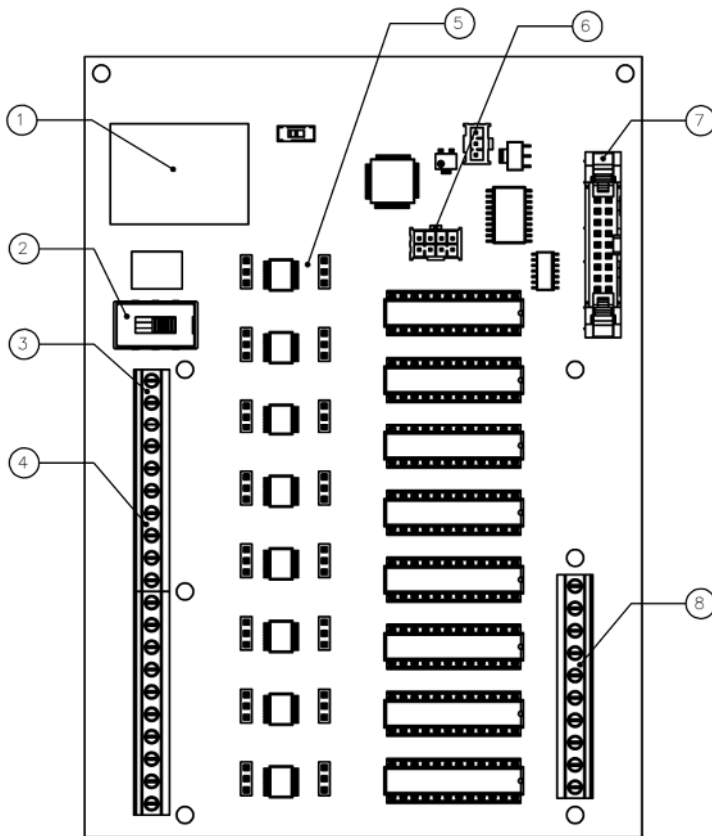

1. RTC battery and memory card region
2. Power On/Off Switch
3. +24VDC/GND Input Power and +5VDC/GND Output Power Terminals
4. Sensor Input Terminals
5. Atlas Scientific, LLC EZO Module Sockets
6. HMI Button Wire Harness Header
7. LCD HMI Header
8. 4-20 mA Analog Output Terminals

1. RTC Battery and Memory Card Region

Insert the Real Time Clock battery (CR2025) and memory card (TF/microSD) in the receptacles in this location.

2. Power On/Off Switch

Use this switch to manually power the board on and off before/after connecting/disconnecting power, sensor, or current loop wiring. Sensor Interface Systems are shipped with this switch in the ON position.

3. +24VDC/GND Input Power and +5VDC Output Power Terminals

Power the board with a +12VDC to +24VDC nominal power source (+24VDC preferred for best analog output performance). Maximum power consumption is up to 5.75W when each EZO socket is populated with Electroconductivity EZO circuits (this is a maximum potential power consumption scenario), not including extra 5VDC loads that might be powered from the output terminal. The analog output circuits may not have enough power to transmit over long wire runs if the system is powered with +12VDC. The power adapter provided with the Sensor Interface System is properly sized for all power scenarios.

4. Input Sensor Terminals

Connect sensor signal and ground wires at these terminals. Alternatively, connect sensor wiring to external terminal strip and wire to the *WaterFeature8* accordingly. The Sensor Interface System is shipped with BNC or SMA connectors for connecting sensors outside of the enclosure. Note: powered sensors such as flow meters may require a separate power supply.

5. Atlas Scientific, LLC EZO Chip Sockets

Insert Atlas Scientific, LLC EZO circuits (and/or ITS WF-IB voltage isolators) in these locations. Take care to correctly orient the parts by lining up the pin labels on the EZO with the silkscreen socket labels printed on the board. *WaterFeature8* System Builder Kits *DO NOT include any EZO circuits*; they must be purchased separately and installed by the user. *WaterFeature8* Sensor Interface Systems *may include pre-installed EZO circuits*; review with your distributor/vendor prior to purchasing.

6. HMI Button Pins

The *WaterFeature8* A-Series System Builder Kit is shipped with four buttons wired to a common connector with approximately 10" of wire. The connector is polarized to fit one way with the onboard pushbutton header. If you need to make your own button wiring harness use Samtec P/N IPD1-04-D-L connector and Samtec CC79R-2024-01-L crimp pins. The *WaterFeature8* Sensor Interface System uses Amphenol 75869-332LF headers with 71600-008LF 8-pos. ribbon cable connectors.

7. LCD HMI Socket

The *WaterFeature8* A-Series System Builder Kit is shipped with an LCD screen and approximately 9" ribbon cable. The ribbon cable plug is designed to fit one way into the board header and LCD module. Make your own LCD ribbon cable using 18 conductor 3M HF365/18SF ribbon cable with Amphenol 71600-018LF (18-pin) IDC connector and strain relief on one end and Amphenol 71600-020LF (20-pin) IDC connector and strain relief on the opposite end.

8. Analog Output Terminals

Connect analog output wires here. The *WaterFeature8* board is considered a sourcing analog device; for PLC compatibility use a sinking or dual sourcing/sinking analog input card.

The following table describes the numerical ranges and resolutions of both the LCD HMI and the analog output current loops.

EZO Circuit Type	Display Value (5 Digits)			Analog Output Values (16-bit Signal Resolution is 0.0000153 mA)		
	Display Resolution	Unit Display	Calibration Points	Low (4 mA)	High (20 mA)	Theoretical Output Resolution
DO	0.01	mg/L	1 or 2	0 mg/L	10 mg/L	0.00015 mg/L
ORP	1	mV	1	-1,020 mV	1,020 mV	0.03 mV
pH	0.01 to 0.1		1, 2, or 3	0	14	0.0002
RTD	0.1 to 1	degC	1	-4 °C	122 °C	0.002 °C
FLO	0.1	Gpm	N/A	0 gpm	525.12 gpm	0.008 gpm
EC	0.001 to 1	µS/cm	Dry, then 1 or 2	0 uS/cm	200,000 uS/cm	3.05 µS/cm
CO2	1	ppm	N/A	0 ppm	10,000 ppm	0.15 ppm
O2	00.01 to 10.00	%	N/A	0 %	42 %	0.0006 %
HUM	00.01 to 10.00	%	N/A	0 %	100 %	0.0015 %
PRS	0.01 to 1	Inch	N/A	0 inch	1,385 inch	0.021 inch

The previous table describes the functional ranges of the *WaterFeature8* hardware. It is important to note that the display range or analog resolution of a particular EZO does not infer a greater or lesser degree of *sensor* resolution or EZO circuit accuracy. Measurement accuracy is also a function of the sensor accuracy and is subject to potential signal noise and, as in all things scientific, significant digits.

3.1 Power Consumption

The *WaterFeature8* system may operate between +12VDC and +24VDC input power, however, the Sensor Interface System is provided with a +24VDC power supply, and it is recommended to supply +24VDC to the circuit board:

Minimum Power Consumption @24VDC nominal = 0.5W [0.02A]

Maximum Power Consumption @ 24VDC nominal = 5.75W [0.24A]

Actual power consumption will vary based on which EZO modules are populated on the board and the analog output current ranges while in use.

Environmental temperature ranges are:

Minimum Temperature = -20 °C [-4 °F]

Maximum Temperature = 60 °C [140 °F]

Note that the LCD module will appear sluggish at low temperatures and may interfere with normal display operations, however, this does not interfere with sensor readings or analog output performance.

3.2 Sensor Interface System Enclosure

The Sensor Interface System enclosure is constructed of UV stabilized polycarbonate and is UL94-HB flammability rated. The enclosures are originally rated for NEMA 4X service but the enclosure penetrations and electronic devices negate this rating. Contact Integrated Treatment Systems if a specific enclosure performance rating is required.

This system is NOT NEMA 4X rated, however, a custom solution may be attainable with modifications.

4 INSTALLATION

Depending on the product you have purchased, the *WaterFeature8* system will require different installation methods. System Builder Kits are intended to be installed in user provided assemblies and/or enclosures, whereas Sensor Interface Systems are fully enclosed, mounted, plugged in, and switched on.

The *WaterFeature8* Sensor Interface System is a tool to be used for observing water quality parameters. It may also perform as part of a PID control loop when connected to a third-party PLC system. *It is good engineering practice to consider how critical each piece of hardware is to the control loop system, and to plan for and design appropriate fail-safe hardware and/or procedures accordingly. Integrated Treatment Systems, LLC is not responsible for process disruption due to hardware or firmware failure.*

4.1 Mounting Dimensions, *WaterFeature8* Circuit Board

The following image shows each of the eight (8) 0.15 inch [3.8 mm] diameter mounting holes for the *WaterFeature8* board.

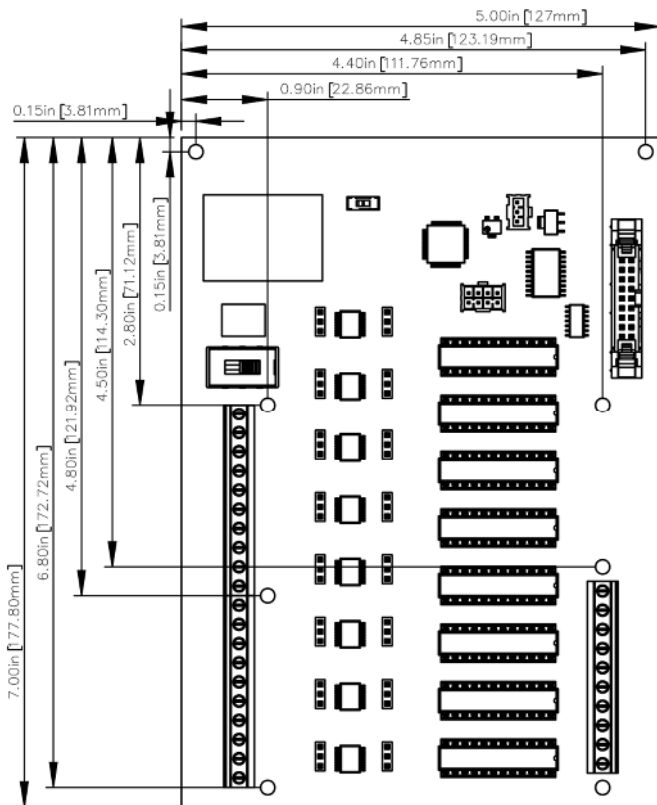

Use the provided spacers and screws when installing the *WaterFeature8*. If other mounting methods are preferred, consider that the board is 0.063" (1.6 mm) thick when selecting mounting devices.

4.2 Installation Procedure, System Builder Kit

The following installation method is recommended for new installations of the *WaterFeature8* System Builder Kit.

1. *** Confirm the Power Switch is in the OFF position. ***

Complete steps 2 through 9 in any order:

2. If desired, carefully mount the *WaterFeature8* board, LCD HMI, and Pushbuttons onto subpanel or enclosure frame.

EZO circuits can be installed before or after mounting the circuit board.

3. Install up to eight (8) EZO circuits and/or WF-IB voltage isolation circuits. Carefully inspect socket labels and properly orient the EZO circuit so that the correct terminals are aligned. Set the EZO circuit firmly in the socket.
4. Wire sensor signal and ground/shield wires to the corresponding screw terminals on the input side of the board. Land signal wires on the PRB# terminal and ground/shield wires on the PGND# terminal. Exercise caution to segregate main signal and ground/shield wiring to minimize interference that may result in jumpy or jittery readings.
5. If 4-20 mA analog output functionality of the *WaterFeature8* is desired on Serial+Analog models, wire to the corresponding screw terminals A1 through A8 on the output side of the board. These connections are NOT REQUIRED to enable the local display, the *WaterFeature8* will continue to display sensor values on the LCD screen without analog connections. Two GND terminals are provided to complete the current loops.
6. Connect the button wiring harness into the HMI button wiring harness header, noting the polarity direction of the socket. The LCD screen shows button commands 1 through 4 vertically down the right side of the display, with button 1 at the top down and button 4 at the bottom. The corresponding header pins are marked [SW1] through [SW4] on the *WaterFeature8* board.
7. Connect the LCD ribbon cable into the LCD HMI header on the board and on the LCD panel, noting the polarity direction of the sockets. The brightness of the LCD can be adjusted in the **Settings** menu.
8. Connect incoming 12-24VDC power and ground wiring to the input power terminals.
9. Carefully install the provided CR2025 coin cell battery by aligning the positive side of the battery with the '+' sign noted on the PCB silkscreen. Then, gently "pry" the metal battery holder tab and slide the battery into the socket until it snaps in place. There are no external indicators to indicate proper installation, however, if real time clock data is not retained on power off the battery is either 1) incorrectly installed, or 2) discharged.

Once steps 3 through 9 are complete, start the *WaterFeature8* system:

10. Slide the Power Switch to the ON position to initialize the firmware operating system. There is a short delay when powering on the board to allow EZO circuits time to perform their internal startup routines before the *WaterFeature8* firmware starts.
11. If this is the first time starting the *WaterFeature8* system, configure the EZO circuits using one of the methods described in Chapter 6.

During each power-on cycle the *WaterFeature8* system will query each channel and automatically confirm EZO circuit installations. It will then

automatically enter Local State and continually poll each EZO circuit in ascending numerical order at a rate of approximately two circuits per second but varies based on the specific types of circuits that are mounted.

The order/sequencing of EZO circuits does not matter. The LCD screen will display the channel number of each EZO based on its insertion location on the *WaterFeature8* board.

4.3 Mounting Dimensions, Sensor Interface System

The following image shows the overall dimensions and the hole pattern for each of the four (4) 0.172 inch [4.4 mm] diameter mounting holes for the *WaterFeature8* Sensor Interface System enclosure. The enclosure dimensions are noted below:

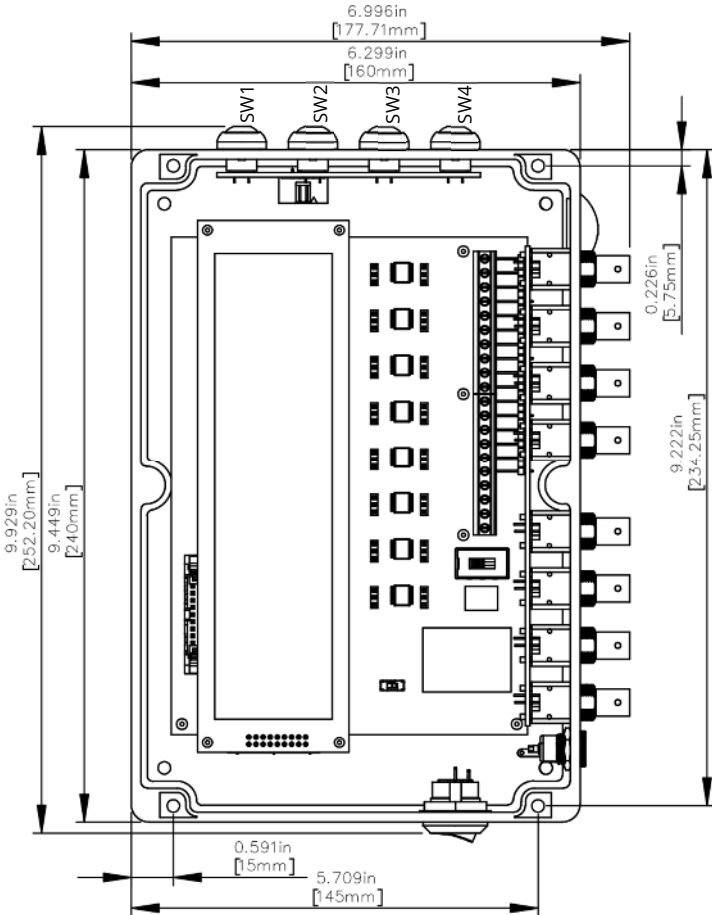

Use the following hole pattern if using the mounting screws provided with the Sensor Interface System enclosure:

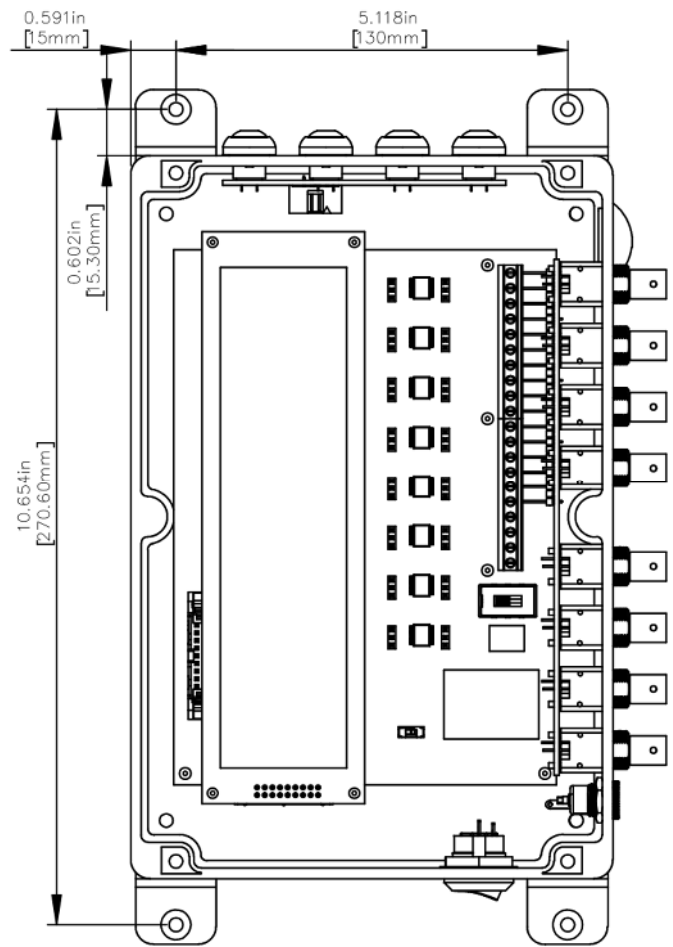

4.4 Installation Procedure, Sensor Interface System

The following installation method is recommended for new installations of the *WaterFeature8* Sensor Interface System.

1. *** Confirm that power to the system is OFF by switching the Rocker power switch to '0' and unplugging the power adapter.***

Complete steps 2 through 8 in any order:

2. If desired, carefully mount the Sensor Interface System enclosure before inserting EZO circuits. EZO circuits can be installed before or after mounting the circuit board.
3. Install up to eight (8) EZO circuits and/or WF-IB voltage isolation circuits. Carefully inspect socket labels and properly orient the EZO circuit so that the correct terminals are aligned. Set the EZO circuit firmly in the socket.
4. If 4-20 mA analog output functionality of the *WaterFeature8* is desired on Serial+Analog models, wire to the corresponding screw terminals A1 through A8 on the output side of the board. These connections are NOT REQUIRED to enable the local display; the *WaterFeature8* will continue to display sensor values on the LCD screen without analog connections. Two GND terminals are provided to complete the current loops.
5. Confirm the PWR switch on the *WaterFeature8* board is in the ON position. It is shipped in the ON position but may be switched OFF for troubleshooting purposes in the field.

6. Connect the 120VAC-24VDC power adapter from a U.S. standard 2-prong wall outlet to the DC input power jack on the bottom of the Sensor Interface System enclosure.
7. Connect sensors to the BNC terminals located on the bottom face of the Sensor Interface System.
8. Carefully install the provided CR2025 coin cell battery by aligning the positive side of the battery with the '+' sign noted on the PCB silkscreen. Then, gently "pry" the metal battery holder tab and slide the battery into the socket until it snaps in place. There are no external indicators to indicate proper installation, however, if real time clock data is not retained on power off the battery is either 1) incorrectly installed, or 2) discharged.

Once steps 3 through 8 are complete, start the *WaterFeature8* Sensor Interface System:

9. Flip the enclosure Power Switch (rocker) to the ON position to initialize the firmware operating system. There is a short delay when powering on the system to allow EZO circuits time to perform their internal startup routines before the *WaterFeature8* firmware starts.
10. If this is the first time starting the Sensor Interface System, configure the EZO circuits using one of the methods described in Chapter 6.

During each power-on cycle the *WaterFeature8* system will query each channel and automatically confirm EZO circuit populations. It will then automatically enter Local State and continually poll each EZO circuit in ascending numerical order at a rate of approximately two circuits per second but varies based on the specific types of circuits that are mounted.

The order/sequencing of EZO circuits does not matter. The LCD screen will display the channel number of each EZO based on its insertion location on the *WaterFeature8* board.

4.5 WF-IB Isolation Board Installation

If voltage isolation is being installed, the WF-IB isolation boards are connected *between* the WF8 PCB and the EZO circuit. Align the WF-IB with the "WF-IB" text in the lower right hand corner of the connection as shown in the following graphics.

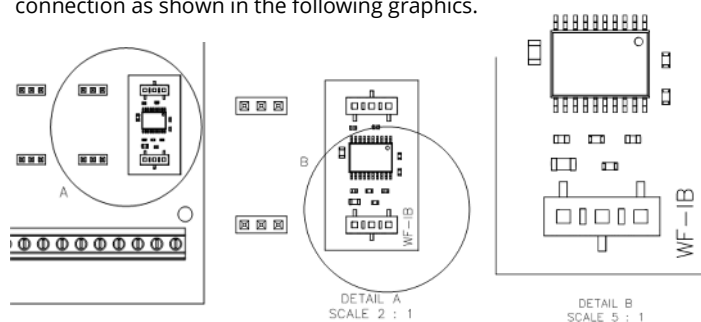

5 EZO CIRCUIT SETUP

There are three ways to set up Atlas Scientific, LLC EZO circuits to function with the *WaterFeature8* system:

1. Using the AutoConfig function available on firmware v1.02 and later,
2. Manually using a terminal emulator and serial converter,
3. Using the built-in Remote State function (see Chapter 9).

This section of the user manual describes the first two methods of EZO programming. Programming an EZO circuit will NOT overwrite existing calibration that has been previously programmed into the EZO memory. Accordingly, using the AutoConfig or manually configuring an EZO will not reset calibration settings as long as an EZO "Factory Reset" has not been performed.

EZO circuits must be in UART mode to be visible to the *WaterFeature8* system. EZO circuits are shipped from the factory in UART mode by default, however, it is possible to accidentally change an EZO mode from UART to I2C, and if this occurs, the EZO must be manually changed back to UART. Refer to EZO circuit documentation for more information regarding the "factory" command and modes of operation.

5.1 Automatic Configuration

The Automatic Configuration function works with all compatible EZO circuits to provide a hassle-free method of programming factory default installed EZO circuits without a terminal emulator or serial communications device.

To run the AutoConfig feature:

From the Home Screen, press **Set-->** [SW4] (Switch 4 is the bottom button on the right-hand side of the enclosure) to enter the **Settings** menu tree. Browse the menus to find AutoConfig by pressing **System-->** [SW1], then **NEXT-->** [SW3], and finally **AutoConfig-->** [SW2].

When AutoConfig is called the system displays the following AutoConfig menu:

```
WaterFeature8 EZO AutoConfiguration
Function Initiated
Press CONFIRM to Continue  Confirm-->
                             Back-->
```

Pressing **Back-->** [SW4] immediately returns to the **System 2** menu.

Pressing **Confirm-->** [SW3] begins the AutoConfigure procedure and the *WaterFeature8* begins programming the EZO circuits it recognizes in the populated channels. While running, the following display is shown:

```
WaterFeature8 EZO AutoConfiguration
CONFIGURING EZOs.....
```

The AutoConfig function happens typically requires less than a few seconds to perform. Once complete, the following screen displays for 3 seconds:

```
WaterFeature8 EZO AutoConfiguration
COMPLETE
```

At this point the AutoConfig function has finished and the *WF8* system immediately reboots. After rebooting the *WF8* Home screen will correctly display the proper EZO circuits in the correctly installed channels.

If the EZO circuits do not appear on the Home screen after rebooting something has failed during AutoConfig. The user may attempt to run AutoConfig again to see if this corrects the issue, otherwise Manual Configuration may be required. Faulty EZO circuits may not be recognized by the *WaterFeature8* system, and/or EZO circuits in a different mode (such as I2C) may not be visible to the *WaterFeature8*.

5.2 Manual Configuration

If the AutoConfig function fails to properly set up an EZO circuit, or the user prefers to program their EZO circuits manually, the following procedure describes the required EZO parameters to be compatible with the *WaterFeature8* system.

Refer to the EZO datasheets downloadable from www.Atlas-Scientific.com for additional instructions on programming EZO circuits. A brief programming guide can be downloaded from www.intreatsys.com/downloads if additional programming instruction is desired.

The following general guidelines are recommended when manually configuring EZO circuits.:

1. Each EZO circuit will need to be set for UART communication mode. Although UART is the default mode from the factory, we recommend checking this when programming any EZO.
2. The Protocol Lock command is recommended to lock the EZO into UART so it cannot accidentally be changed to I2C mode.
3. Unused EZO outputs will need to be disabled such as continuous readings, 'OK' response, and other values not used by the *WaterFeature8* firmware.
4. If reusing or repurposing previously deployed EZO circuits, issuing a Factory Reset command to the EZO may be recommended prior to configuration for use with the *WaterFeature8*. Consult the Atlas Scientific datasheets when performing a Factory Reset.

If manually configuring with a device other than the *WaterFeature8*, we recommend using an Atlas Scientific electrically isolated USB EZO Carrier Board (P/N USB-ISO) to connect the EZO circuit to a computer, although many other commercially available serial UART converters will work if the correct TX/RX/GND pins are connected. A terminal emulator such as Tera Term is needed to send commands to the connected EZO circuit. Other methods of connection and software terminals may also be used to program the EZO circuits.

The following descriptions include the settings that must be configured on each EZO prior to installation. Parameters shown in *italics> are factory default settings; they do not need to be programmed unless they have been manually changed.*

Dissolved Oxygen (DO)

- *Set UART baud rate to 9,600:* Baud, 9600
- *Enable mg/L output:* O, mg, 1
- *Disable saturation outputs:* O, %, 0

- Disable continuous readings: C, 0
- Disable 'OK' response function: *OK, 0

Oxidation Reduction Potential (ORP)

- Set UART baud rate to 9,600: Baud, 9600
- Disable continuous readings: C, 0
- Disable 'OK' response function: *OK, 0

pH

- Set UART baud rate to 9,600: Baud, 9600
- Disable continuous readings: C, 0
- Disable 'OK' response function: *OK, 0

Temperature (RTD)

- Set UART baud rate to 9,600: Baud, 9600
- Set temperature scale to Celsius: S, c
- Disable continuous readings: C, 0
- Disable 'OK' response function: *OK, 0

Flow (FLO)

- Set UART baud rate to 9,600: Baud, 9600
- Set time value to minutes: Frp, m
- Disable Total Volume Output: O, TV, 0
- Enable Instantaneous Flow Rate Output: O, FR, 1
- Disable continuous readings: C, 0
- Disable 'OK' response function: *OK, 0

The *WaterFeature8* board is designed to work in gallons per minute (gpm) units. Atlas Scientific, LLC meter K-values are in metric units. The K-value volume terms must be manually translated into gpm by multiplying by the appropriate volume ratio. For example, for a K-value in liters per minute of K,1.5,2 is either 1.5 liters per two pulses or 1.5 lpm at 2 Hz. Multiplying the middle term by 0.264, which is the ratio of gallons:liters yields a new K-value of K,0.396,2. Also, when calculating the conversion term be sure to account for differences in time value (e.g. volume/second versus volume/minute).

This programming must be done by manually connecting the EZO to a computer and using a terminal emulator and entering each K-value as needed using one of the following commands depending on how many K-values there are:

If there is only 1 K-value:

K, [vol. per pulse], [number of pulses]

If there are multiple K-values:

K, [vol. at freq.], [freq. in Hz]

Supplemental guidelines for performing this programming can be found on the ITS website at www.intreatsys.com/downloads. Refer to the Frequently Asked Questions www.intreatsys.com/faq page for more information regarding flow meter calibration.

Refer to the Flow EZO datasheet for additional programming information.

Conductivity (EC)

- Set UART baud rate to 9,600: Baud, 9600
- Enable conductivity: O, EC, 1
- Disable total dissolved solids output: O, TDS, 0
- Disable salinity output: O, S, 0
- Disable specific gravity output: O, SG, 0
- Disable continuous readings: C, 0
- Disable 'OK' response function: *OK, 0

The *WaterFeature8* is designed to operate with EC compatible sensors of K-value 0.1, 1.0, and 10.0. Analog outputs are limited to a maximum of 200,000 μ S/cm at 20 mA.

Carbon Dioxide (CO2)

- Set UART baud rate to 9,600: Baud, 9600
- Disable internal temperature output string: O, t, 0
- Disable continuous readings: C, 0
- Disable 'OK' response function: *OK, 0

Oxygen (O2)

- Set UART baud rate to 9,600: Baud, 9600
- Enable percent concentration output string: O, %, 0
- Disable parts per thousand output string: O, PPT, 1
- Disable continuous readings: C, 0
- Disable 'OK' response function: *OK, 0

Humidity (HUM)

- Set UART baud rate to 9,600: Baud, 9600
- Enable humidity output string: O, HUM, 1
- Disable internal temperature output string: O, t, 1
- Disable dew point output string: O, Dew, 1
- Disable continuous readings: C, 0
- Disable 'OK' response function: *OK, 0

Pressure (PRS)

- Set UART baud rate to 9,600: Baud, 9600
- Disable unit identifier output: U, 0
- Set units to inches of water: U, inh2o
- Set decimal output to 2: Dec, 2
- Disable continuous readings: C, 0
- Disable 'OK' response function: *OK, 0

6 STARTING THE *WaterFeature8*

Start the *WaterFeature8* System Builder Kit by applying 24 VDC and Ground to the input terminal block and turning the [POWER] switch to the ON position. For the Sensor Interface System, switch the rocker switch on the left side of the enclosure to the ON position.

Every time the *WaterFeature8* is started a brief boot screen is shown similar to the following:

```
WaterFeature8(TM)          V#.##
A-series
                          Copyright 2018-2022
                          Integrated Treatment Systems, LLC
```

After the boot screen is shown the *WaterFeature8* firmware scans the hardware sockets for powered EZO circuits, during which the following screen is shown:

```
Scanning for EZOs.....
```

The EZO scanning time varies based on the unique combination of populated circuits.

Next, the firmware checks the installed positions of EZO circuits and compares them to the previously installed position. Depending on previous ON status and EZO circuit configuration, different screens may be shown.

6.3 Temperature Compensation Detection

If this is the first time booting the *WF8* system it will likely display the following screen:

```
NOTICE
EZO Reconfiguration Detected
All Temperature Compensation
Assignments RESET      OK -->
```

The EZO detection scheme is used to retain Temperature Compensation values if they have been previously assigned. This notice occurs when the detected EZO circuit population is different from the previously installed population. On first boot this is due to the random configuration of EZO circuits installed when installing firmware and performing QA/QC at the ITS shop, because it is not likely that the user's specific EZO installation locations match our shop combination.

However, for future power cycles, if the EZO circuit locations have not been changed the *WaterFeature8* will instead display a screen confirming that previously assigned Temperature Compensation assignments are retained because the EZO population matches the previous population before the power OFF/ON cycle.

```
EZO Configuration Confirmed
All Temperature Compensation
Assignments RESTORED
```

6.4 Main Menu/Home Screen

Once the system completes the boot cycle it will immediately enter the Home screen, which is also referred to as the Main Menu screen. The Home screen displays all populated EZO circuits as well as their active measurements. On the right-hand side of the home screen

there will be one or more submenu selection buttons depending on the current firmware version. The Home screen looks like this:

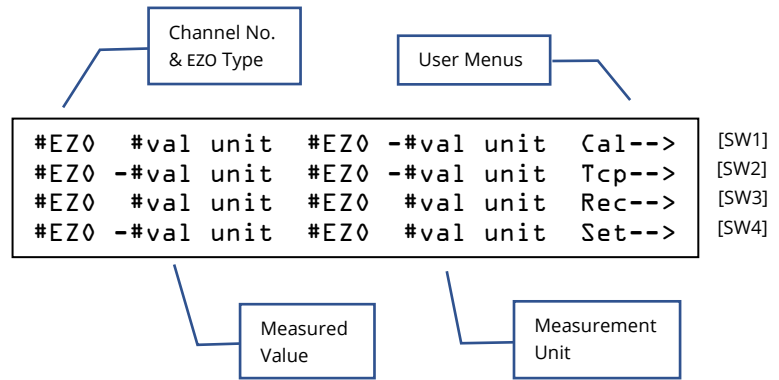

The Home screen will only display EZO circuits that have been properly configured to work with the *WaterFeature8* system. While in operation the Home screen continually shows the measured reading of the populated EZO circuit and on Serial+Analog models will output an appropriately scaled 4-20mA current if connected to an external Programmable Logic Controller, Analog Input device, or other system compatible with 4-20mA current loops. Refer to the Device Specifications chapter of this manual for information related to 4-20 mA analog output scaling.

If you do not see any EZO/sensor readings on screen when first starting the system, run the Automatic Configuration function as described in Chapter 5.

7 CALIBRATION INSTRUCTIONS

Many sensor/EZO combinations can be calibrated using the on-board Calibration submenu (**Cal-->**) to reset the sensor known points to fixed values programmed in the *WaterFeature8*. Sensor recalibration may also be warranted if measured values appear to be significantly outside anticipated performance parameters, but this is a judgement call to be made by the system operator.

The calibration procedures are intended to be intuitive, but each particular EZO circuit has different requirements to be considered properly calibrated.

7.1 General Calibration Procedures

Calibration Mode is entered by pressing **Cal-->** [SW1]. The most recently accessed calibration submenu screen will appear:

```
#EZO #val unit           Next-->
                          Prev-->
                          CALIBRATE-->
                          Main Menu-->
```

While in Calibration Mode the firmware will freeze all continuous output and 4-20 mA signals at their current value. These output signals will begin sending updated values as soon as calibration is complete and the system returns to the Main Menu/Home screen.

Once a sensor is calibrated the new calibration values will be stored in the non-volatile memory of that sensor's EZO circuit. Sensor calibrations DO NOT need to be performed after a power loss as they are permanently stored in the sensor circuit until the next calibration event.

The general calibration procedure is as follows:

1. When the Calibration submenu appears, the current channel is displayed in the top left corner of the LCD screen. Press **Next-->** [SW1] or **Prev-->** [SW2] to cycle between the various installed sensor channels. *Note, when in Calibration Mode the sensor values shown on the LCD screen may not be correct even after completing calibration due to internal calculation scaling. If this occurs proceed with the calibration procedure anyway. The correct values will be calculated and displayed on the Main Menu/Home screen.* Do not be alarmed if the characters "*ERO" appear momentarily when cycling through channels. This is a result of the communication timing between the firmware and the EZO and does not indicate equipment failure.
2. Once the desired sensor channel is shown in the upper-left portion of the screen, press **CALIBRATE-->** [SW3] to proceed with the EZO specific calibration procedure.
3. Press **Main Menu-->** [SW4] to return to the Main Menu/Home screen.

7.2 EZO Specific Calibration Procedures

Each sensor has unique calibration values. Standard calibration fluids can be purchased from Atlas Scientific at www.atlas-scientific.com or from other vendors. However, the calibration fluid target values programmed into the *WaterFeature8* cannot be changed.

Refer to the EZO datasheets from Atlas Scientific, LLC for additional descriptions of calibration methods and theories.

1. Prepare the desired sensor and place in ambient air or calibration solution as required by the sensor. If placed in calibration fluid, ensure air bubbles are not trapped at the face of the sensor which may skew calibration values.
2. Watch sensor readings on the LCD until they stabilize. This can take between 10 and 90 seconds. Allow for more time if a reading appears to quickly reach a calibration high or low limit such as 0.00 mg/L dissolved oxygen.
3. This part of the procedure varies for different EZO sensors:
 - a. For single point calibration sensors RTD and ORP:

Follow the on-screen sensor placement instructions and press **CALIBRATE-->** [SW1] to proceed to step 4.
 - b. For multiple point calibration sensors DO, pH, and EC:

Press the appropriate calibration initiation button once to enter the point-specific submenu. This might be [CAL LOW-->] or [CAL HIGH-->] or something similar depending on the sensor being calibrated. The point-specific submenu will display sensor placement instructions. Follow the instructions, then press **CALIBRATE-->** [SW1] to proceed to step 4.
4. The word "CONFIRM-->" will begin to flash. Momentarily press the flashing **CONFIRM-->** [SW1] button to store the calibration in the sensor's EZO circuit. The word "CONFIRMED" will illuminate solid.
5. Depending on if the EZO requires a specific calibration order, the calibration software will display "CALIBRATION COMPLETE" and either return to the top Calibration Menu or it will proceed to the next calibration point.
6. Continue calibrating devices (return to Step 2, above) or press **Main Menu-->** [SW4] to exit Calibration Mode and display all installed sensor channels.

7.2.1 DO/Dissolved Oxygen

Dissolved oxygen may be calibrated at one or two different points:

- Single point calibration (ambient air)
- Dual point calibration (this is an optional calibration for sensors needing to read accurately below 1.0 mg/L).

The first calibration point is between 9.09 and 9.1X mg/L which is the ambient air calibration value. The second calibration point is 0.00 mg/L and requires Zero DO calibration solution.

Single point calibration may be performed without Dual point calibration. If this is desired press **CANCEL-->** [SW4] on the DO calibration screen after performing the [CAL HIGH] calibration step. This will return to the Calibration Menu. However, when performing Dual point calibration the air calibration value [Cal HIGH] *must* be set before the 0.0 mg/L [CAL LOW] second point.

7.2.2 ORP/Oxidation-Reduction Potential

Oxidation-Reduction Potential is calibratable to a single point, +225 mV.

After pressing **Cal** --> [SW1] on the LCD HMI, follow the on-screen prompts to complete calibration.

7.2.3 pH

pH may be calibrated at the following points:

- Single point
- Dual point
- Triple point

The three available calibration points are at pH of 4.0, 7.0, and 10.0, using fluids manufactured to the appropriate pH. Calibrating pH = 7.0 will reset HIGH and LOW calibration points. Therefore, when performing single point calibration use pH = 7.0. If performing dual- or three-point calibration, calibrate the center point (pH = 7.0) first, then proceed calibrating the next one or two points in either order.

7.2.4 RTD/Temperature

Temperature is calibratable to a single point, 10 °C (50 °F).

A small bath of 10 °C (50 °F) water can be made up with tap water and a few ice cubes in a small cup. Use a known calibrated thermometer to establish the 10 °C (50 °F) control temperature.

7.2.5 FLO/Flow

Flow meters are not calibrated the way submersible sensors are and attempting to calibrate a flow meter via the Calibration Menu will display a "No CALIBRATION REQUIRED" message. However, K-values for any given flow meter may be manually adjusted after performing a bucket test or by comparison versus a known good meter and reprogramming the K-values in the Flow EZO. Adjusting EZO K-values can be done while the Flow EZO is connected to the *WaterFeature8* and commands can be sent via Remote State (see chapter covering Remote State in this manual). Bucket testing also requires translating observed flow per unit time information from the bucket test into pulse volume and pulse frequency data for K-value input. Reference www.intreatsys.com/faq for more information on calibrating flow meters.

The firmware polling cycle routine is programmed to take a minimum of one second to ensure that Flow meter pulses down to 1 Hz will be readable by the firmware. Flow meter pulses slower than 1 Hz may be incorrectly observed to be 0.00 gpm.

7.2.6 EC/Electroconductivity

Conductivity is calibratable to one or two points.

The conductivity values shown during calibration are raw values and they are both truncated and unscaled. Given screen character constraints the firmware currently shows only the raw data from the EZO during calibration. This means that the values may not visibly stabilize in the calibration fluid due to rounding error. Be sure to allow ample stabilization time prior to confirming calibration points.

For any EC sensor the initial calibration point is Cal Dry (0.00 µS/cm). This tunes the EZO to the specific sensor and only needs to be done once whenever A) a new sensor is installed, B) an existing sensor is disconnected and reconnected, or C) a different EC EZO circuit is installed in the channel.

Single point calibration is done to the [Cal Mid] value of 12,880 µS/cm, while dual point calibration is done to [Cal Mid] (12,880 µS/cm) first and [Cal High] (80,000 µS/cm) second. Once calibration is complete, and while still viewing the Calibration Menu, the EC submenu should

display 1288 for [Cal Mid] and 8000 for [Cal High]. These values will properly update to display in µS/cm on the Main Menu.

EC calibration should be done while the EZO fluid temperature is set to 25C, which is the factory default setting, and will remain at this setting until the user manually changes the temperature with the "RT,#" command OR enables Temperature Compensation for the channel. Fluid specific calibration values can be used if calibrating via Remote State commands, but local Calibration menus currently support Atlas Scientific EC calibration fluid values at 25C. Exercise caution when calibrating at fluid temperatures other than 25C.

Note, the Conductivity calibration submenu allows for the calibration procedures to be completed in any order, however, the instruction provided above should be followed carefully.

7.2.7 CO2/Carbon Dioxide

This device is factory calibrated. Although field calibration can be done on these sensors, the *WaterFeature8* calibration submenu is not programmed to facilitate this.

7.2.8 O2/Oxygen

This device is factory calibrated. The *WaterFeature8* calibration submenu is not programmed to facilitate this.

7.2.9 HUM/Humidity

This device is factory calibrated. The *WaterFeature8* calibration submenu is not programmed to facilitate this.

7.2.10 PRS/Pressure

This device is factory calibrated. The *WaterFeature8* calibration submenu is not programmed to facilitate this.

7.3 Calibration Tips

Calibrating sensors can often require a bit of skill, knowledge, patience, and in some cases repeated calibrations. The following tips may help wrangle finicky sensor calibrations into compliance.

- When pressing the button during the flashing **CONFIRM-->** prompt there is a slight delay in the firmware while communication with the EZO is executed. This requires a momentary press and hold action to affirmatively complete the calibration.
- Some sensors seem to operate better after performing the two point calibration procedure twice in a row.
- If a sensor does not appear to calibrate or otherwise does not settle onto a stable value during immersion in calibration fluid, attempt to recondition the sensor with reconditioning fluids or rebuild the sensor with a rebuild kit. Additional information can be found at www.atlas-scientific.com or from the sensor supplier. This does not apply for EC sensors.
- After calibration, confirm proper device measurement by observing the sensor value while submerged in the calibration fluid. It should be the same value as the calibration fluid or reasonably close within some allowable error. If the value continues to change while resting in calibration fluid, wait a little longer until the values stabilize and recalibrate the sensor.

- Revising the K-value of a DC-pulse type flow meter requires performing a flow calibration test. Visit www.intreatsys.com for recommendations on calibrating flow meters. *Note, turbine style dc-pulse meters are not known to be highly accurate. Do not use these meters for legally required flow monitoring such as regulatory permit compliance flow reporting.*
- If sensor values appear unreasonably “jittery” during operation or calibration, confirm that the proper type of field wiring is installed and firmly connected.
- Follow the long-term storage requirements of each sensor when possible. This includes using sensor caps and storage fluids when required by the sensor manufacturer.
- Some sensors must stay wet and are not allowed to dry out. Take this into consideration if installed in a reactor that is regularly emptied or has a regularly changing water level.

8 TEMPERATURE COMPENSATION

The Temperature Compensation (TComp or **TCp-->**) feature is designed to improve the accuracy of pH, DO, and EC EZO circuits by supplying liquid temperature data from an RTD EZO with temperature probe. The temperature data is used by the pH, DO, or EC circuit to adjust, or compensate, the output value to a more accurate number. The science of temperature compensation is beyond the scope of this manual, however, Atlas Scientific, LLC provides additional documentation in their EZO datasheets.

Only pH, Dissolved Oxygen, and Electroconductivity EZO circuits are eligible for temperature compensation.

Temperature compensation support was added in firmware v1.10. The WaterFeature8 does not currently support pressure or salinity compensation for any EZO circuits. Temperature compensation is limited to 1 °C maximum resolution.

The TComp feature is accessed by pressing **TCp-->** [SW2] while on the Main Menu/Home screen.

8.1 TComp Initiation

When the **TCp-->** [SW2] is selected from the Main Menu/Home screen the Temperature Compensation submenu routine begins and the WF8 firmware will freeze analog output values at their current readings and stop reporting continuous output serial data streams.

The firmware will immediately confirm if any RTD EZO circuits are installed and if none are installed will display "NO RTD FOUND // Temperature Compensation Not Available". After 3 seconds the program will automatically return to the Main Menu/Home screen.

```
NO RTD FOUND
Temperature Compensation Not Available
```

8.2 Channel Target Assignments

If RTD EZO circuits are installed and discovered during system startup, the TComp submenu starts with the most recently observed TCp channel displayed in the upper left-hand corner of the display. Similar to the Calibration submenu, the **Prev->** [SW1] and **Next->** [SW2] buttons will cycle through the available populated channels, and the channel displayed in the upper left corner of the screen will be considered "active."

If an active channel is not eligible for temperature compensation (i.e. is populated with an ORP, RTD, or Flow EZO circuit), the active channel will display "Not eligible for Temperature // Compensation". When the active channel is ineligible for temperature compensation **Cycle TCp->** [SW3] will do nothing.

```
#EZO                               Prev->
  Not Eligible For Temperature     Next->
  Compensation                     Cycle TCp->
                                   Main Menu->
```

If the active channel is eligible for temperature compensation (i.e. is populated with a pH, DO, or EC EZO circuit), the active channel will display "Temperature Compensation // from CH# RTD".

```
#EZO                               Prev->
  Temperature Compensation         Next->
  From CH# RTD                    Cycle TCp->
                                   Main Menu->
```

If no temperature compensation channel is currently assigned for the active channel (this is the default condition until a temperature compensation RTD channel is assigned), the octothorpe (# sign) is displayed. If a temperature compensation channel is identified for the active channel, then the appropriate channel is identified in lieu of the octothorpe. *This channel number matches the RTD EZO channel from which the active channel will receive temperature values.*

When the user presses **Cycle TCp->** [SW3] the temperature compensation channel will cycle to the next higher observed RTD channel. When the available RTD channels are exhausted the octothorpe will again be displayed to indicate that the active channel is not being temperature compensated. Pressing **Cycle TCp->** [SW3] will continue to assign compensation channels from the various populated RTD channels.

Note, there is no explicit "save temperature compensation function" in the TCp submenu. The firmware assumes that if a temperature compensation channel is tagged then this is what the user has selected to compensate the active channel. If no channel is identified (i.e. the # sign is displayed) then the active channel is not temperature compensated.

At any time during navigation of the TCp submenu the user may press **Main Menu->** [SW4] to return to the Main Menu/Home screen. Channel compensation targets will be automatically saved to system memory and will be retained if system power is lost.

The Temperature Compensation function allows for any pH, DO, or EC EZO channel to receive temperature values from any populated RTD EZO channel. Accordingly, one RTD EZO channel could provide temperature readings to up to seven other channels as well. Any combination of assignments is theoretically possible, although any specific DO, pH, or EC EZO may only receive temperature readings from ONE assigned RTD EZO circuit.

9 DATA RECORDING

On-board data recording is done via the Trans Flash (TF/microSD) card slot provided on the Generation 3 and later *WaterFeature8*. The insertion socket is uni-directional and will only accept the card if oriented vertically in the proper direction, with the card label facing “left” and the pins facing “right.”

WARNING:

DO NOT force the TF card into the card reader slot. This will damage the card reader and render the on-board data recording function of the WaterFeature8 unusable. Warranty protection does not extend to users forcefully destroying the card reader of their device. And yes, we can tell.

The data recording function is only operable while the system is in Local State on the Home Screen/Main Menu. While the system is in Remote State or in an on-board menu, the recording function is suspended until the system returns to the Home Screen/Main Menu. After a set interval the *WF8* will record the most recent polling cycle data to the memory card.

9.1 Card Configuration

The TF card reader is compatible with Trans Flash style memory cards up to 32 GB size. This includes microSD™ and microSDHC™ standard devices. ITS does not endorse any particular brand of memory card, however, we have tested several different popular brands and have found all of them to function correctly.

The memory card must be formatted using the FAT32 file system. The *WF8* does not include provisions for performing on-board card formatting, and this must be done on a separate computer.

Card Type: TF, microSD, microSDHC
File System: FAT32

9.2 Recording Setup

Enter the recording menu by pressing [SW3] while on the Home Screen. The *WF8* will display the following record settings screen:

```
Record Interval          ^
00:00:01                >
New File Interval       Start-->
000 hours               Main Menu-->
```

Navigate the Record Interval and New File Interval durations using [SW1] ‘^’ and [SW2] ‘>’ buttons.

9.2.1 Record Interval

The Record Interval sets an internal timer that the *WF8* checks at the end of every polling cycle if the Record Interval timer has expired it will save the most recent polling data and reset the timer. Consider that due to polling cycle times which may vary depending on the currently deployed combination of EZO circuits, the Record Interval timer is likely to expire *before* a polling cycle finishes. This means that the actual Record Interval is *at least* the value specified on this menu, *plus* the partial remaining polling cycle time.

If exactly timed data recordings are required, consider placing the *WF8* in Remote State and write a custom program to collect data as commanded. Refer to the Remote State chapter of this manual for more information.

9.2.2 New File Interval

The New File Interval functions similarly to the Record Interval. The New File Interval time (in hours) sets an internal timer that is checked at the end of every polling cycle. If the timer has expired, the *WF8* will record the most recently polled data, then save the file and create a new file.

The file naming convention is “LOG####.txt”, where #### is the next sequential number of LOG .txt files found on the memory card. The *WF8* will continue adding LOG files until either A) the card runs out of memory, or B) the LOG file numbers attempt to exceed 9999. Regardless of which condition occurs, an error code prompt will flash on the Home Screen/Main Menu.

9.2.3 Start Recording

Press [SW3] to set the data recording flag. This effectively mounts the memory card to the *WF8* firmware and enables the system to see the device and write LOG files to it. When the switch is pressed the “Start-->” text will convert to “Stop-->” text, which indicates that the system is currently in record mode.

Press [SW4] to exit the data recording setup menu and return to the Home Screen/Main Menu. The Home Screen will now flash the “Rec-->” text next to [SW3] and the green data recording LED will flash at the same time on the *WF8* PCB. The flashing interval simply indicates that the system is in “record mode” and does not indicate the data recording frequency or any particular moment when data is being recorded.

9.3 Data Format

The *WF8* will record data in the .txt file as comma separated values, or CSV. They will be displayed in the *WF8* channel order from 1 to 8, left to right, and will contain the raw data received from the EZO circuit.

A timestamp can be appended to the front of the data stream by enabling this feature in the Timestamp submenu in Settings.

```
Timestamp
Continuous Output Timestamp  ON -->
Data Record Timestamp       ON -->
                             BACK -->
```

Press [SW3] to toggle the Data Recording Timestamp ON or OFF.

The timestamp format follows an **ISO 8601** standard matching this convention:

YYYY-MM-DDThh:mm:ss

The hour “hh” value is in 24 hour format. The timestamp is followed by a single space character to separate it from the recorded data on the same line. For example:

2022-03-21T19:50:23 7.83,4.046,8.76,-253

This string shows that the record date/time is March 21, 2022 at 7:50 PM (and 23 seconds). When importing the data into a spreadsheet such as Microsoft Excel™ include the options to delimit by *commas and spaces* to ensure the timestamp is properly separated from the first recorded data.

This timestamp text format can be parsed into separate Date and Time columns in Excel by using these basic formulas:

Date: “=DATEVALUE(MID(A1,1,10))”

Time: "TIMEVALUE(MID(A1,12,8))"

... where cell A1 is the cell containing the separated timestamp text. Additional day/date formatting can be done in the individual cell settings.

9.4 Error Codes

The *WaterFeature8* can report certain error codes contained within the data recording libraries. If the Data Recording function is active when an error code is encountered, data recording will halt, the green LED will flash twice as fast, and the "Rec-->" text will change to "Error->". Press [SW3] to observe the error code. Otherwise, the error code will display immediately when it is encountered.

9.4.1 Common Error Codes

The following list contains the most common list of error codes that may be encountered.

Error Code 1 :: DISK_ERR

Description: Occurs when there is an error making a new file or writing to a file. This is a general disk error that may occur if the card is removed and/or inserted while recording is active.

What to Do: Remove and reinsert the memory card, reinstate data recording function. If the problem persists, insert it into a computer and confirm the file system format is FAT32.

Error Code 3 :: NOT_READY

Description: Occurs when the hardware (*WF8* or memory card) is not ready to record data. Usually occurs if a memory card is not inserted when data recording is activated.

What to Do: Confirm that a properly formatted memory card is inserted into the card reader socket correctly.

Error Code 127 :: MAX_FILES

Description: Occurs when the maximum number of LOG files is encountered on the memory card. Up to 9,999 individually numbered LOG files can be created on a memory card.

What to Do: Carefully consider the new file interval settings in the Record Data menu to prevent the counter from exceeding 9,999 before revisiting the memory card and extracting the data.

9.4.2 Obscure Error Codes

The following table identifies all of the possible error codes that might be encountered, although highly unlikely.

15	TIMEOUT	Could not get a grant to access the volume
16	LOCKED	The operation is rejected according to the file sharing policy
17	NOT_ENOUGH_CORE	LFN working buffer could not be allocated
18	TOO_MANY_OPEN_FILES	Number of open files > _FS_SHARE
19	INVALID_PARAMETER	Given parameter is invalid

Error Code ID	Error Code	Description
2	INT_ERR	Assertion failed
4	NO_FILE	Could not find the file
5	NO_PATH	Could not find the path
6	INVALID_NAME	The path name format is invalid
7	DENIED	Access denied due to prohibited access or directory full
8	EXIST	Access denied due to prohibited access
9	INVALID_OBJECT	The file/directory object is invalid
10	WRITE_PROTECTED	The physical drive is write protected
11	INVALID_DRIVE	The logical drive number is invalid
12	NOT_ENABLED	The volume has no work area
13	NO_FILESYSTEM	There is no valid FAT volume
14	MKFS_ABORTED	The f_mkfs() aborted due to any parameter error

10 REMOTE COMMUNICATIONS

Starting with Firmware version 2.01, the *WaterFeature8* operating system has two distinct modes: 1) **Local State**, and 2) **Remote State**.

While in Local State the *WF8* system will operate automatically, polling EZO circuits, outputting serial data streams, and updating the 4-20 mA outputs indefinitely. Local calibration, temperature compensation, and settings menus remain accessible using the 4-button interface.

While in Remote State, the *WF8* system temporarily suspends Local State and provides a fast and responsive RS-232 communications priority directly to the *WaterFeature8* microprocessor and the populated EZOs. While in Remote State the 4-20 mA board outputs (on Serial+Analog models) will remain locked at the last observed values from Local State operation until they are updated with the Read All command (discussed below). Remote State is a temporary condition; it exists on a countdown timer (described below) to ensure that if the remote connection fails the system will eventually return to Local State.

10.1 Connecting Remotely

The *WaterFeature8* remote communications protocol allows a remote user to communicate with the system, as well as connect directly with the populated EZO circuits, over the RS-2323 serial connection. For System Builder Kit *WF8* systems this connector is the 3-pin programming header. For Sensor Interface System *WF8* devices this connector is the female DB-9 connector located on the enclosure.

The remote system accessing the *WaterFeature8* will need to be able to send *ASCII* encoded character commands in *string* format. The remote access header provides an RS-232 connection at these settings:

- 115,200 baud
- 8 data bits
- 1 stop bit
- No parity
- No flow control

When accessing the system via terminal emulator the recommended terminal setup settings are:

- New Line:
 - Receive: Carriage Return + Line Feed
 - Transmit: Carriage Return
- Local Echo: Enabled

However, for experienced users we recommend working with a terminal emulator configured to your comfort level.

10.2 Startup Performance

The default startup mode of the *WaterFeature8* is Local State. Once bootup is complete the remote communications commands will be enabled. These remote functions are locked out until bootup is complete to ensure that any local hardware changes made by a user while the power is off are scanned and initiated before Remote State can resume control of the system.

Booting to Local State allows for local troubleshooting in the event that a user is physically interfacing with the panel and intends to operate the system locally, but the firmware is otherwise captured in a remote state loop. This could possibly happen if the remote program is still operating, or if a communications error is hijacking the system.

Power-cycling the *WF8* will restore local control on bootup. However, if remote commands are being received from a remote client, Remote State may become active as soon as boot procedures are complete. To prevent unwanted interruptions while operating the system manually in Local State, turn off the remote data stream or temporarily unplug the remote access header, which can be done while the power is ON without harming the system.

10.3 Remote State Initialization

The command to initialize Remote State is **rem ####** (space separating the command and the numbers), where the #-sign indicates the duration, in seconds, of the Remote State countdown timer. The *WF8* will remain in Remote State for # seconds, and when the timer expires it will revert to Local State.

Whenever any command is received over the serial connection *after* initiating Remote State, the Remote State timer will reset to the last value of ####. For example, if a **rem 30** command is received, the system will enter remote state for 30 seconds. If a **rem 20** command is received before the 30 second countdown expires, the existing countdown timer will be dropped and a new 20 second countdown timer will commence.

If any other command is received or sent over the serial connection while in Remote State, the timer will reset to the duration of the last used **rem ####** command. This will allow an external user to ensure that Remote State is maintained indefinitely without having to send the **rem ####** command, but it also allows the system to revert to local mode automatically if the remote link times out.

The maximum amount of time that Remote State can be requested is 9,999 seconds (approximately 166 minutes or 2.77 hours). **rem ####** commands above 9,999 will default to a value of 9,999 seconds.

When a **rem ####** command is received from a remote device, the *WaterFeature8* will perform one of the following actions:

- If it is currently on the Home screen and in the process of polling channels it will finish polling to the last populated socket, then suspend polling operations until the Remote State timer expires.
- If it is currently in a submenu such as Calibration or Temperature Compensation it will immediately enter Remote State.

10.4 Remote State Local User Interface

While in Remote State the *WaterFeature8* will display the following screen:

```
REMOTE STATE ENABLED
##### SECONDS REMAINING

Interrupt and Switch to Local State -->
```

If a local user presses [SW4] while in Remote State, the *WaterFeature8* will revert to Local State. [SW1], [SW2], [SW3] are disabled while in Remote State.

When the system switches from Remote State to Local State it will default to the Main Menu/Home screen and will begin automatically polling regardless of what sub-menu may have been active when Remote State was requested. If a local user manually switches to Local State but does not disconnect the remote serial communications wire, the remote program may end up re-establishing Remote State with the **rem ####** command. Switching

to Local State DOES NOT prevent remote commands from being submitted to the *WaterFeature8*, nor does it prevent the *WaterFeature8* from performing those commands.

If the system is in Local State and a user is performing on-site operation, when a remote command other than **rem #####** is received by the *WaterFeature8* the remote command will be executed and the system will revert back to the Main Menu/Home screen. The remote connection wire harness should be disconnected if local operation needs to be uninterrupted, for example, during sensor calibration. Do not forget to plug the remote connection wire back in. The system does not need to be powered off to plug or unplug the remote connection cable.

10.5 Command Definitions

There are three types of eligible remote commands that can be received by the *WaterFeature8*: State Commands, Native Commands, and Encapsulated Commands.

Commands sent to the system will be answered as long as the system is in Remote State or on the Home screen in Local State. Commands received while the system is in a Submenu in Local State (such as TCp or Cal) will return "ERROR, Invalid Command." When a command is received in Local State on the Home screen, responses will be delayed until the end of the current polling cycle.

Remote State is the preferred mode of operation if the system is primarily used over a remote connection. This is because the speed of the command responses will be limited only by the EZO processing and communication speed.

10.5.1 Syntax

Remote State ASCII communications primarily follow a "command_argument" type of syntax (where the underscore "_" is a space). A command *without* arguments will not have any spaces, and a command *with* arguments will have a space between the command and the argument.

In this manual commands are noted in bold and red, such as **text**. Each command sent from the remote device should be followed by a carriage return notated herein as [CR]. Command and argument text is not case sensitive.

Return strings are notated *inside* braces, for example {text} denotes that the text between the braces is what returns from the *WF8* to the remote device. Return strings may have different parts to them, and may be comma delimited, as defined below:

{CH#} indicates the socket/channel number of the *WaterFeature8*.

{EZO} indicates the identifying code for the EZO circuit currently installed in any given socket. The codes are always three characters long and are defined as:

{DO_} → Dissolved Oxygen

{ORP} → Oxidation Reduction Potential

{pH_} → pH

{RTD} → Temperature

{FLO} → Flow

{EC_} → Electroconductivity

{CO2} → Carbon Dioxide gas

{O2_} → Oxygen gas

{HUM} → Relative Humidity

{PRS} → Pressure

{Empty Socket} is returned if no EZO is installed in a polled socket.

{vww} is the variable length response string that is received from the corresponding EZO circuit. Polarity signs are included in the {vww} response and are not identified separately. Values are always returned to the remote device as ASCII text strings.

10.5.2 State Commands

State Commands are used to switch the *WaterFeature8* between Local State and Remote State operation modes.

rem ##### :: Suspends Local State, initializes Remote State, and returns {WFOK}[CR]. Starts a countdown timer equal to ##### seconds. When the timer expires, the system automatically reverts back to Local State.

rem 0 :: Immediately drops Remote State and switches the *WF8* system back to Local State and returns {Leaving Remote State}[CR].

Note that whenever any command is received by the *WaterFeature8* the remote timer is reset to the last received **rem #####** value.

10.5.3 Native Commands

There are a few commands that are intended specifically for the *WaterFeature8* that may save time when developing custom remote software or troubleshooting the system remotely. These commands generally automate a sequence of EZO commands and report the results back in a large string of data. Each of the Native commands is prefaced with "WF" text before the command. A response consisting of {WFOK}[CR] is returned at the completion of every Native command response. The Native commands are:

WFinfo :: Returns the firmware version of the *WaterFeature8* in format {FW #.##}[CR].

WFstate :: Returns the current state of the *WaterFeature8*; either {LOCAL}[CR] for Local State or {REMOTE}[CR] for Remote State.

WFreadinfo :: Performs one complete polling cycle sending the EZO **i** command to each populated socket. The return string format is {CH#,EZO,?,EZO,vww}[CR] for each channel reading.

WFreadall :: Performs one complete polling cycle by sending the EZO **r** command to each populated socket. Note that this does not send the temperature compensated read command **rt,n** to the EZO circuit, although if there are any previously stored temperature readings in the EZO the reading will be temperature compensated by default. The return string format is {CH#,EZO,vww}[CR] after each channel reading. This command updates 4-20 mA analog output values for each channel.

WFreadunits :: Performs one complete polling cycle sending the EZO **u** command to each populated socket. The return string format is {CH#,EZO,vvv}[CR] after each socket reading. The **u** command is not currently available in every EZO at the time of this manual creation and many EZO circuits will simply return {CH#,EZO,*ER}[CR] if this is the case.

WFautoconfig :: Initializes and runs the AutoConfiguration subroutine. However, in remote mode this routine runs *without* a local user prompt. The remote user should wait several seconds after running this command, and then send at least two **WFreadall** commands to clear errant communication strings before continuing with remote instructions.

WFsysreset :: Performs a system reset request on the *WaterFeature8*. This simulates a power OFF/ON cycle on the microprocessor. There should be no reason to execute this command during normal remote operations. However, it is included as a command of last resort in the event that the system stops functioning as expected.

10.5.4 Encapsulated Commands

Encapsulated commands allow the remote device to communicate directly to each populated EZO circuit. Most commands discussed in the EZO datasheets are available for use by submitting commands within the encapsulation protocol, with the exception of certain commands that could catastrophically cut communications to the EZO circuit. This is intended to give the remote user a direct interface with each EZO circuit, and the response that the *WaterFeature8* returns over the remote line shall be exactly as it is received from the EZO circuit.

Each *Encapsulated* command is prefaced with **s** to identify it as different from a *Native* command. To send a command *through* the *WaterFeature8* to a receiving EZO circuit, the remote user must first tell the *WF8* which socket (i.e. sensor, or channel) is the target, and the convention is as follows:

- **s_#,EZOCmd**
- Where:
 - **s** :: Indicates that the following command is a pass-through to one of the EZO populated *WaterFeature8* channels.
 - **_** :: Indicates a space.
 - **#** :: Indicates the channel that the command will be passed to, and must be a number 1 through 8.
 - **,** :: Separates the channel identifier from the EZO command.
 - **EZOCmd** :: Replace this with the exact EZO command as it is shown in the EZO datasheet.

For example, submitting **s 3,r** will send the 'read' command to the EZO located in socket 3 and will return the exact response from the EZO back to the remote device, followed by the [CR] if one is sent from the EZO. Note, **s #,r** DOES NOT update 4-20 mA analog output values. To update analog outputs use the **WFreadall** command.

Since nearly every EZO command can be sent via this encapsulation protocol, the user must exercise caution when modifying configuration settings that are critical to the *WaterFeature8* operating system. Specifically, the items discussed in [Chapter 5 EZO Circuit](#)

Setup should not be modified unless the user intends to primarily keep the system in Remote State. Modifying these configuration settings could interfere with Local State functionality and may render certain Local State calibration and temperature compensation functions inoperable.

10.5.5 Restricted Commands

To prevent unwanted commands from breaking the link between the EZO and the *WF8*, all EZO **baud,n**, **c,1**, and **i2c,n** commands are locked out and unavailable for use. EZO circuit factory default speed is 9600 baud and the *WF8* system is designed to communicate with these circuits at this baud rate. Also, changing an EZO circuit from UART to I2C mode will automatically reboot the circuit and it will no longer be readable by the *WaterFeature8*. The logical implication of passing these commands to an EZO is that a user will have to visit the local device and reconfigure the EZOs manually, or perform a factory reset on the EZO, to bring the device back into the compatible communications settings. These restricted commands are intended to prevent this from accidentally happening.

9.5.6 System Errors

When an unrecognizable system command is received the *WaterFeature8* will respond with

{ERROR, Invalid Command}[CR]

If a locked out character is sent, the *WaterFeature8* will respond with

{ERROR, Command Locked Out}[CR]

If an encapsulated command is passed to channel number that is not 1 through 8, the *WaterFeature8* will respond with

{ERROR, Channel Number Out of Range}[CR]

If an encapsulated command is passed to a channel but there is no response received from the EZO, the *WaterFeature8* will respond with

{ERROR, Timeout}[CR]

10.6 Remote State Best Practices

The *WaterFeature8* firmware was initially developed to function autonomously with limited human interaction. It was designed to be as simple and reliable as possible, while also being as flexible as possible to accommodate all of the Atlas Scientific EZO products. However, EZO products have become quite diverse, and the following strategies will help guide the user when deploying remote capability.

- If the remote user accidentally resets something on an EZO that was not intended, such as setting up the OK response with ***OK,1**, use the **WFautoconfig** command to reset all of the EZO circuits back to a *WaterFeature8* compatible configuration. However, after running the remote AutoConfiguration command, the user should execute at least two cycles of **WFreadall**, or send **WFsysreset**, to clear any buffers that might be waiting in the firmware queue.
- When a user is operating the *WaterFeature8* from the local device and the system is power cycled, the *WF8* will scan for EZO circuits and report if the arrangement of EZO circuit population has changed, as described in the Temperature Compensation chapter of this manual. If an EZO is manually changed or experiences an electrical failure, and if the system is power cycled with the **WFsysreset** command, the EZO will be dropped from the populated channel list while

running the Temperature Compensation assignment checks during the boot process. When the TCp boot check observes a change in EZO population the *WaterFeature8* requires local user intervention to acknowledge the change in EZOs (by pressing [SW4]), however, the remote user will not receive notification that this has happened. To remotely proceed through this notice, any legitimate Remote State command sent from the remote device will acknowledge the prompt and force the boot sequence forward.

- If the **WFsysreset** command is sent, do not issue commands until the reboot process is complete. The system can take 10 +/- seconds to finish rebooting depending on EZO population. Any commands sent during the reboot process are likely to be overwritten by subsequent commands until booting is complete. While these commands are not problematic for the boot sequence, they may cause erroneous communications until the system is fully booted.
- If an encapsulated EZO command is sent through the *WaterFeature8*, but the EZO command returns nothing, the encapsulated *WF8* command will time out. For example, the PRS EZO command **dec,n** is used to change the number of decimal places in the pressure reading. This EZO command does not return a value or a [CR] after updating, and therefore the *WaterFeature8* response will time out. In this example, to confirm that the command was received by the EZO, send **s #,CMD,?** command to the correct channel and the EZO will respond with the current value. For the example mentioned above, send **s #,dec,?** and the correct decimal value will be returned from the EZO circuit, thereby confirming that the initial command was received and implemented. This is not a bug, it is a feature!
- Temperature compensation assignments that are made by a local user in Local State will be suspended when Remote State is requested. If the system passes back into Local State, temperature compensation values will resume as they were previously assigned. While in Remote State, the automatic temperature compensating process that is normally active in Local State will no longer function, however, the temperature values stored in EZO memory will be retained. If on-going temperature compensation is required, the user should program the remote system accordingly.
- The **WFreadall** command sends the EZO **r** command and DOES NOT send the more specific EZO **rt,n** command. However, if the **t,n** or **rt,n** command is sent through the encapsulation protocol, for example, by sending **s #,t,n** or **s #,rt,n**, then the temperature will be saved in the EZO and future read requests to that EZO will return compensated values at that temperature. Therefore, the system programmer should consider the **WFreadall** command as a quick tool for collecting readings from all populated sockets, but consideration should also be given to periodically updating temperature values for relevant EZO circuits via the encapsulation commands. This is particularly important for DO and EC readings which are particularly sensitive to water temperature. Also,

WFreadall is the only Remote State command that will update the analog output values.

- If the onboard 4-20 mA outputs are used for an external process control system(s), as opposed to using the remotely obtained sensor values to control equipment, consider operating the system using limited Remote State commands while the *WaterFeature8* is in Local State. The response time for remote commands will be delayed by the polling sequence, but the output current loops will be automatically updated with every polling cycle. Otherwise, if operating this type of process control system in Remote State, consider using a low **rem ####** value, for example 30 seconds, and regularly submit the **WFreadall** command to ensure that the 4-20 mA outputs are current. This way, if the remote countdown timer expires, the system will revert to Local State relatively quickly and will continue polling and updating 4-20 mA outputs, thereby minimizing control feedback loop interruption for devices that may depend on these analog values.
- Note, the encapsulated command **s #,r** DOES NOT update 4-20 mA analog output values. For this, use the **WFreadall** command. And yes, we know this is stated in multiple places in this chapter. It is just . that . important.

11 BILL OF MATERIALS

The following items are included with the *WaterFeature8* System Builder Kit:

#	Description	Qty	Source	Part Number
1	<i>WaterFeature8</i> A-Series Circuit Board	1	Integrated Treatment Systems	PCBA-1.3
2	4x40 LCD Display	1	Newhaven Display International	NHD-0440AZ-FL-YBW
3	Display Ribbon Cable ¹	1	3M	HF365/18SF
4	Ribbon Cable IDC Connector ¹	1	Amphenol	71600-018LF 71600-020LF
5	SPST-NO Button ²	4	E-Switch	S1024ABLK
6	Push Button Wiring ²	1	Varies	20ga or 22ga UL1007/1569 Hookup Wire
7	Push Button Connector ²	1	Samtec	IPL1-04-D-K

1: Display ribbon cable and connectors (parts 3 and 4) are shipped pre-assembled.

2: The push button wiring harness (parts 5, 6, and 7) is shipped pre-assembled.

The following items are included with the *WaterFeature8* Sensor Interface System:

#	Description	Qty	Source	Part Number
1	<i>WaterFeature8</i> A-Series Circuit Board	1	Integrated Treatment Systems	PCBA-2.3
2	Polycarbonate Enclosure ¹	1	Bud Industries	PN-1340(C) w/PNX-91440
3	Mounting Brackets and Screws	4	Bud Industries	MB-1390-LG
4	4x40 LCD Display	1	Newhaven Display International	NHD-0440AZ-FL-YBW
5	Display Ribbon Cable ¹	1	3M	HF365/18SF
6	Display Ribbon Cable IDC Connector	1	Amphenol	71600-018LF 71600-020LF
7	SPST-NO Button	4	E-Switch	RP8100B2M1CE BLKBLKNIL
8	Push Ribbon Cable	1	3M	HF365/08SF
9	Push Button Ribbon Cable IDC Connector	2	Amphenol	71600-008LF
10	Enclosure Rocker Power Switch	1	E-Switch	RR3130ABLKBLKFS
11	Power Jack	1	Tensility Intl.	54-00063
12	AC/DC Converter Wall Adapter	1	CUI	SWI24-24-N-P5
13	Spare 7/8" Grommet	1	Essentra Components	GR3155A
14	Spare 7/8" Bushing	1	Essentra Components	22AF0875
15	CR2025 Battery	1	Varies	N/A
16	#6-32 Hex Nut for Grounding Post	1	Varies	N/A

1: All components are shipped pre-assembled to the enclosure except, of course, items #12-16.

Refer to www.intreatsys.com/shop for additional products such as the WF-IB Isolator Board for in-line voltage isolation.

12 WF8 VERSION HISTORY & EZO

COMPATIBILITY

The following version data provides a historical record of hardware and firmware development to date.

Hardware

PCB Ver.	Date	Description
1.2	Oct. 2018	Initial release
1.3	Apr. 2020	Added +5VDC/GND terminals, revised board thickness and color, added fuse

12.1 Firmware

FW Ver.	Date	Description
1.01	Oct. 2018	Initial public release
1.02	Apr. 2019	Added AutoConfig feature, released
1.10	May 2019	Added Temperature Compensation submenu, EZO population checks, and other minor HMI tweaks
1.11	May 2019	Minor updates, bug fixes
1.12	May 2019	Added 'OK' prompt to Reconfiguration Detected boot screen
1.13	May 2019	Minor spelling/grammar changes
1.14	May 2019	Updated Flow EZO v2.0 compatibility, revised AutoConfig function, released
1.20	Jun. 2019	Revised Flow EZO v2.01 output string defaults, updated AutoConfig, added polling cycle timing, revised FLO and RTD output ranges, released
1.30	Oct. 2019	Added CO2 and PRS compatibility, released
2.01	Nov. 2019	Added remote communications capability
2.02	Nov. 2019	Added AD420 updates to WF8readall
2.03	Nov. 2019	Added prompt abort for pH Cal, Mid
2.04	Nov. 2019	Minor spelling updates, abort [SW4] prompt in Remote State
2.05	Nov. 2019	Revised ERROR code responses
2.06	Nov. 2019	ERROR code spelling revisions, released
2.10	Apr. 2021	Added O2 and HUM compatibility, rev'd Remote State commands to use "WF" prefix only
2.11	Apr. 2021	O2 and HUM bugfixes, splash screen, minor spelling updates
2.12	Apr. 2021	Final O2 and HUM edits
2.13	Apr. 2021	Remote State and Native Commands updated, comma delimited. This is the final functional firmware for Generation 1 and Generation 2 <i>WaterFeature8</i> systems.
3.04	Oct. 2021	Firmware re-written and updated for Generation 3 systems. Includes Settings menu, RTC, RS-232, and other minor revisions. Prior FW versions are not fully functional on Generation 3 systems.
3.05	Oct. 2021	Improved LED flashing on RX/TX events.
3.11	Mar. 2022	On-board calibration bugfix, data recording enabled
3.16	Jun. 2022	Removed "Day" input on Clock settings
3.19	Aug. 2022	Added various custom continuous output calcs.

12.2 Compatibility

The following table describes known and tested compatibility of the *WaterFeature8* firmware versus EZO circuit firmware (not to be confused with EZO datasheet versions). Testing is not performed on every new EZO released by Atlas Scientific, LLC unless major command changes are made between EZO versions. Most newly purchased EZO circuits should work with the *WaterFeature8*, and we coordinate with Atlas Scientific, LLC when discussing EZO and WF8 compatibility. Exemptions from this list do not mean an EZO is incompatible (unless

otherwise noted), it simply means we have not physically tested it in our shop.

WF8	DO	pH	ORP	EC	RTD	FLO	CO2	PRS	O2	HUM
1.01	2.12	2.11	2.10	2.12	2.10	<2.0	-	-	-	-
1.02 to 1.14	2.13	2.12	2.10	2.13	2.10	2.00	-	-	-	-
1.20*	2.13	2.12	2.10	2.13	2.10	2.01	-	-	-	-
1.30 to 2.06	2.13	2.12	2.10	2.13	2.10	2.01	1.0	1.0	-	-
2.10 to 3.19	2.13	2.12	2.10	2.13	2.10	2.01	1.0	1.0	1.0	1.0

* *WaterFeature8* firmware versions 1.20 and later are not compatible with FLO EZO firmware versions earlier than 2.01.

13 GUARANTEE

13.1 Warranty Statement

This limited warranty is governed by and construed under the laws of the State of Iowa.

INTEGRATED TREATMENT SYSTEMS, LLC (ITS) WARRANTS ITS PRODUCTS AGAINST DEFECTS IN MATERIALS AND WORKMANSHIP UNDER NORMAL USE FOR A PERIOD OF 1 YEAR FROM DATE OF SHIPMENT ("WARRANTY PERIOD"). IF A DEFECT ARISES AND A VALID CLAIM IS RECEIVED WITHIN THE WARRANTY PERIOD, ITS WILL, AT ITS OPTION AND TO THE EXTENT PERMITTED BY LAW, FOR ANY ITS MANUFACTURED DEVICES THAT ARE RETURNED AND CONFIRMED BY ITS TO BE NON-CONFORMING TO THE PRODUCT SPECIFICATIONS AND/OR THE APPLICABLE QUALITY AND ACCEPTABILITY STANDARDS, EITHER (I) REPLACE THE PRODUCT AT NO CHARGE OR (II) ISSUE A CREDIT EQUAL TO THE ORIGINAL PURCHASE PRICE OF THE PRODUCT. WHEN A PRODUCT IS EXCHANGED, ANY REPLACEMENT ITEM BECOMES THE CUSTOMER'S PROPERTY AND THE REPLACED ITEM BECOMES ITS' PROPERTY. WHEN A REFUND IS GIVEN, THE PRODUCT FOR WHICH THE REFUND IS PROVIDED MUST BE RETURNED TO ITS AND BECOMES ITS' PROPERTY. ITS WILL NOT ACCEPT LIABILITY FOR ANY COST IN ADDITION TO THE VALUE OF THE PRODUCT INCLUDING BUT NOT LIMITED TO COMPONENTS, LABOR, BUSINESS INTERRUPTIONS, PROCESS PERFORMANCE IMPACTS, AND ANY OTHER CONSEQUENTIAL DAMAGES OR LOSSES. ITS DISCLAIMS ANY OPEN-ENDED ACCEPTANCE OF LIABILITY FOR LOSSES BEYOND THE CONTROL OF ITS.

THIS LIMITED WARRANTY DOES NOT APPLY: (A) TO DAMAGE CAUSED BY USE WITH NON-ITS PRODUCTS; (B) TO DAMAGE CAUSED BY ACCIDENT, ABUSE, MISUSE, FLOOD, FIRE, EARTHQUAKE OR OTHER EXTERNAL CAUSES; (C) TO DAMAGE CAUSED BY USE OF THE PRODUCT OUTSIDE THE PERMITTED OR INTENDED USES DESCRIBED IN THE PRODUCT SPECIFICATIONS; (D) TO DAMAGE CAUSED BY SERVICE (INCLUDING UPGRADES AND EXPANSIONS) PERFORMED BY ANYONE WHO IS NOT AN AUTHORIZED REPRESENTATIVE OF ITS; (E) TO A PRODUCT OR PART THAT HAS BEEN MODIFIED TO ALTER FUNCTIONALITY OR CAPABILITY WITHOUT THE WRITTEN PERMISSION OF ITS; OR (F) TO COSMETIC DAMAGE, INCLUDING BUT NOT LIMITED TO SCRATCHES OR DENTS, THAT DOES NOT OTHERWISE AFFECT THE PRODUCT'S FUNCTIONALITY OR MATERIALLY IMPAIR IT'S USE.

TO THE EXTENT PERMITTED BY LAW, THIS WARRANTY AND REMEDIES SET FORTH ABOVE ARE EXCLUSIVE AND IN LIEU OF ALL OTHER WARRANTIES, REMEDIES, AND CONDITIONS, WHETHER ORAL OR WRITTEN, STATUTORY, EXPRESS OR IMPLIED. AS PERMITTED BY APPLICABLE LAW, ITS SPECIFICALLY DISCLAIMS ANY AND ALL STATUTORY OR IMPLIED WARRANTIES, INCLUDING, WITHOUT LIMITATION, WARRANTIES OF MERCHANTABILITY, FITNESS FOR A PARTICULAR PURPOSE AND WARRANTIES AGAINST HIDDEN OR LATENT DEFECTS. IF ANY TERM OF THIS WARRANTY IS HELD TO BE ILLEGAL OR UNENFORCEABLE, THE LEGALITY OR ENFORCEABILITY OF THE REMAINING TERMS SHALL NOT BE AFFECTED OR IMPAIRED. EXCEPT AS PROVIDED IN THIS WARRANTY AND TO THE EXTENT PERMITTED BY LAW, ITS IS NOT RESPONSIBLE FOR DIRECT, SPECIAL, INCIDENTAL OR CONSEQUENTIAL DAMAGES RESULTING FROM ANY BREACH OF WARRANTY OR CONDITION, OR UNDER ANY OTHER LEGAL THEORY, INCLUDING BUT NOT LIMITED TO LOSS OF USE; LOSS OF REVENUE, LOSS OF ACTUAL OR ANTICIPATED PROFITS (INCLUDING LOSS OF PROFITS ON CONTRACTS); LOSS OF THE USE OF MONEY; LOSS OF ANTICIPATED SAVINGS; LOSS OF BUSINESS; LOSS OF OPPORTUNITY; LOSS OF GOODWILL; LOSS OF REPUTATION; LOSS OF DAMAGE TO OR CORRUPTION OF DATA; OR ANY INDIRECT OR CONSEQUENTIAL LOSS OR DAMAGE HOWSOEVER CAUSED INCLUDING THE REPLACEMENT OF EQUIPMENT AND PROPERTY, ANY COSTS OF RECOVERING, PROGRAMMING OR REPRODUCING ANY PROGRAM OR DATA STORED OR USED WITH ITS PRODUCTS. ITS DISCLAIMS ANY REPRESENTATION THAT IT WILL BE ABLE TO MAKE A PRODUCT EXCHANGE WITHOUT RISK TO OR LOSS OF PROGRAMS OR DATA. YOU MUST ASSIST IN DIAGNOSING ISSUES WITH YOUR SYSTEM ELECTRONICS AND FOLLOW ITS WARRANTY PROCESSES.

The following activities will explicitly void this limited warranty:

- Failure to register your product with ITS. Visit www.intreatsys.com/warranty for product registration instructions.
- Soldering or de-soldering any component on the circuit board;
- Running the bootloader on the microprocessor;
- Damaging the Trans Flash card reader, battery holder, or EZO sockets;
- Placing the circuit in environments known to be hostile to circuit boards such as temperatures above 125 °F, extreme thermal shock, high humidity or otherwise moist environments, electrostatic discharge (ESD) susceptible environments, and vibrating or moving conditions.

Shipping expenses related to warranty work outside the contiguous 48 United States are not eligible for coverage or reimbursement

13.2 Quality Assurance

The *WaterFeature8* water quality monitoring system is specifically designed to function in coordination with devices produced by third-party electronics and sensor designers and manufacturers. As such, there are many possible equipment failures that could occur outside our locus of control which might appear as a *WaterFeature8* system failure. Before submitting a warranty claim, we strongly advise the user to perform an appropriate amount of due diligence to confirm that erroneous monitoring results are indeed being caused by the *WaterFeature8* and are not the fault of these third-party devices.

The *WaterFeature8* system undergoes extensive quality assurance and quality control before shipment from our facility. We power the device with an industrial 24VDC power supply, program the device with a known good operating system file, check screen performance and set backlight level, verify pushbutton performance and sub-menu functions, and confirm realistic performance of the 4-20 mA outputs (if so equipped). We complete this level of inspection using state-of-the-technology ESD protection, and exposed circuits are shipped in ESD protective products to minimize the likelihood of electrostatic damage.

Our QA process is designed to ensure that our hand built, high quality product meets your performance expectations. We do not control the after-market assembly facility or deployment environments that our systems may encounter, so we expect our customers to employ the same or greater level of precautionary measures when handling and servicing our systems as we do.

13.3 Design Philosophy

The folks at Integrated Treatment Systems, LLC are always looking for a better way of doing something. Our mission is to make water quality monitoring more robust yet simpler at the same time. For this product we had a vision to collect a large amount of process data in an inexpensive package and this was our solution.

We also believe in simplicity. Our products have been tested in the field to be as functional and reliable as possible. We seek process monitoring accuracy high enough to perform water treatment process adjustments such as change a blower speed, ramp a pump up or down, drive a VFD, open/close/modulate a valve, run a dosing

pump, and other simple analog PID tasks. We also believe Atlas Scientific EZO technology and sensors offer world-class accuracy suitable for laboratory and scientific work.

13.4 Contact Us

We are excited to continue developing cost effective solutions to solving water quality challenges and are looking forward to your suggestions to improve our products.

Feel free to contact us in any of the following ways:

Email: custsomerservice@intreatsys.com

Web: <https://www.intreatsys.com/contact-its>

END

Integrated Treatment Systems, LLC

www.intreatsys.com

customerservice@intreatsys.com



WaterFeature8™

©2022 Integrated Treatment Systems.

Product specifications subject to change without notice.

ITS and the ITS Logo are registered trademarks of Integrated Treatment Systems, LLC.

WaterFeature8, WF8, and the corresponding Logos are trademarks of Integrated Treatment Systems, LLC.

Visit www.intreatsys.com/wf8 for current product information, including the most recent edition of this manual. 2022.08.25