

Click to
ORDER
samples

AMEL2-277NZ



Encapsulated

The new AMEL2-277NZ is a 2W AC/DC converter that offers much greater cost effectiveness due to material normalization and production automation also leading to improved reliability and performance. Offering a wide industrial input voltage range of 85-305VAC and an output voltage range from 3.3-24V, this series will offer many benefits to your new system design.

This new series offers great operating temperatures, from -40°C to 70°C and isolation of 4000VAC for improved reliability and system safety. Furthermore, a high MTBF of 300,000h, output short circuit protection (OSCP) and output over-current protection (OCP) come standard with the series.

The AMEL2-277NZ is perfect for street lighting controls, grid power, LED, instrumentation, industrial controls, communication and civil applications.

Features

- Universal Input: 85 - 305VAC/120 - 430VDC
- Operating Temp: -40 °C to +70 °C
- High isolation voltage: 4000VAC
- Low ripple & noise, 200mV(p-p), max.
- Output short circuit, over-current protection
- Regulated Output

Summary

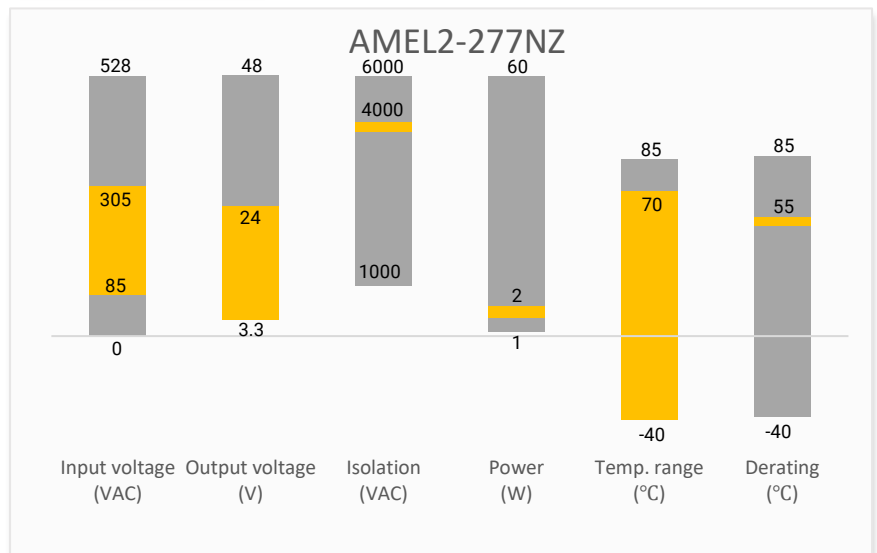

Training

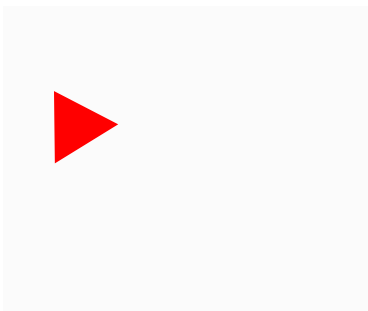

Product Training Video
(click to open)

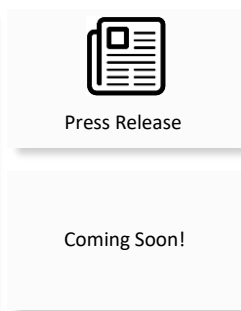

Application Notes

Applications



Power Grid



Industrial



Telecom



Instrumentation

Models & Specifications

Single Output						
Model	Input Voltage (VAC/Hz)	Input Voltage (VDC)	Output Voltage (V)	Output Current max (mA)	Maximum capacitive load (μF)	Efficiency @ 230VAC Typ. (%)
AMEL2-3.3S277NZ	85~305/47~63	120~430	3.3	600	4000	65
AMEL2-5S277NZ	85~305/47~63	120~430	5	400	4000	70
AMEL2-9S277NZ	85~305/47~63	120~430	9	222	2200	72
AMEL2-12S277NZ	85~305/47~63	120~430	12	167	2200	76
AMEL2-15S277NZ	85~305/47~63	120~430	15	133	1000	76
AMEL2-24S277NZ	85~305/47~63	120~430	24	83	680	78

Note: Use suffix "ST" for chassis and suffix "STD" for DIN-Rail mounting (ex. AMEL2-5S277NZ-ST is chassis mounting and AMEL2-5S277NZ-STD is DIN-Rail mounting version).

Input Specifications				
Parameters	Conditions	Typical	Maximum	Units
Input Current	115VAC		110	mA
	230VAC		31	
Inrush Current	115VAC	7		A
	230VAC	14		
Leakage Current			0.25	mA
External Input Fuse	1A/300V, slow-blow type			

Output Specifications				
Parameters	Conditions	Typical	Maximum	Units
Voltage accuracy	3.3V output model	± 6		%
	Others	± 5		
Line regulation	Full load	± 2		%
Load regulation	10-100% load	± 5		%
Ripple & Noise	20MHz bandwidth	100	200	mV p-p
Hold up time	230VAC	50		ms
No load power consumption			0.2	W

Isolation Specifications				
Parameters	Conditions	Typical	Maximum	Units
Tested I/O voltage	60 sec, Leakage current < 5mA	4000		VAC

General Specifications				
Parameters	Conditions	Typical	Maximum	Units
Over Current protection	Self- recovery	≥ 120		% of I _{out}
Short circuit protection	Hiccup, Continuous, Auto-recovery			
Operating temperature		-40 to +70		°C
Storage temperature		-40 to +105		°C
Power derating	-40°C ~ -25°C	3.3		% / °C
	55°C ~ 70°C	3.3		
	85 ~ 100 VAC	1.33		% / VAC
Temperature coefficient		±0.04		% / °C
Protection Class	Class II			
Cooling	Free air convection			
Storage Humidity			95	% RH
Case material	Heat resistant black Plastic (flammability to UL 94V-0)			
Weight	PCB mountable models	20		g
	With optional -ST mounting plate	40		
	With optional -STD mounting plate	60		
Dimensions (L x W x H)	PCB mountable models	1.33 x 0.87 x 0.71 inches (33.70 x 22.20 x 18.00mm)		
	With optional -ST mounting plate	2.99 x 1.24 x 1.06 inches (76.00 x 31.50 x 26.80mm)		
	With optional -STD mounting plate	2.99 x 1.24 x 1.24 inches (76.00 x 31.50 x 31.40mm)		
MTBF	> 300 000 hrs (MIL-HDBK -217F, t=+25°C)			
NOTE: All specifications in this datasheet are measured at an ambient temperature of 25°C, humidity<75%, nominal input voltage and at rated output load unless otherwise specified.				

Safety Specifications		
Parameters		
Standards	Designed to meet IEC/EN/UL 62368	
	EMC - Conducted and radiated emission	CISPR32 / EN55032, class B
	Electrostatic Discharge Immunity	IEC 61000-4-2 Contact ±6KV, Air ±8KV, Criteria B
	RF, Electromagnetic Field Immunity	IEC 61000-4-3 10V/m, Criteria A
	Electrical Fast Transient/Burst Immunity	IEC 61000-4-4 ±2KV, with EMC recommended circuit, Criteria B
	Surge Immunity	IEC 61000-4-5 L-L ±1KV/ L-G ±2KV, with EMC recommended circuit, Criteria B
	CS, Conducted Disturbance Immunity	IEC 61000-4-6 10Vr.m.s, Criteria A
	Voltage dips, Short Interruptions Immunity	IEC 61000-4-11 0%, 70%, Criteria B

Derating

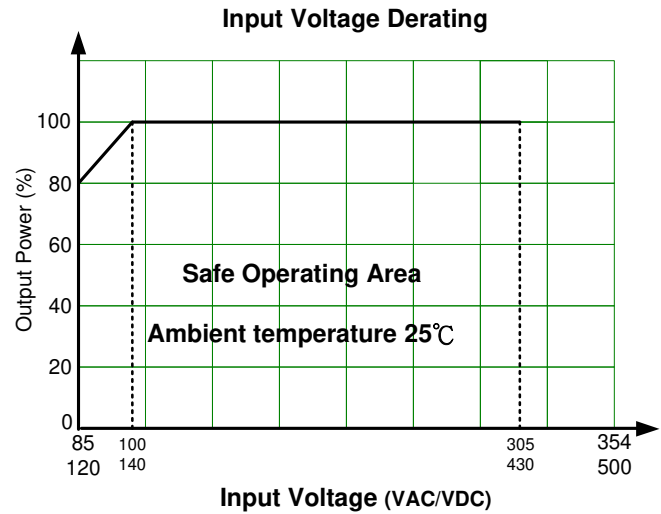
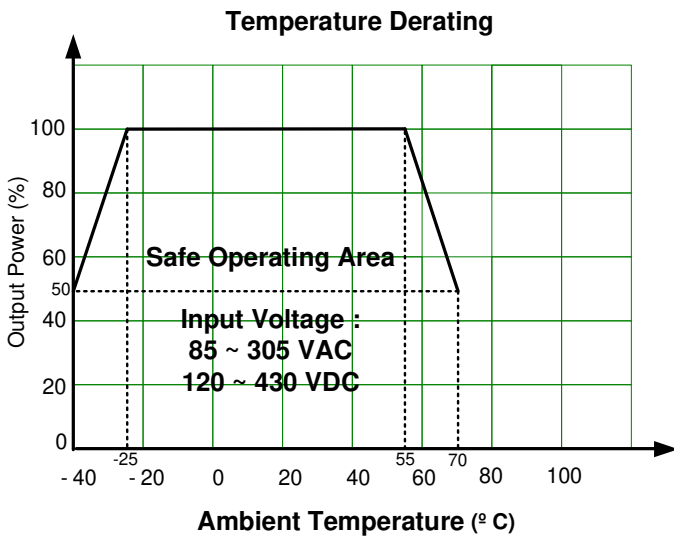

Typical Application Circuit

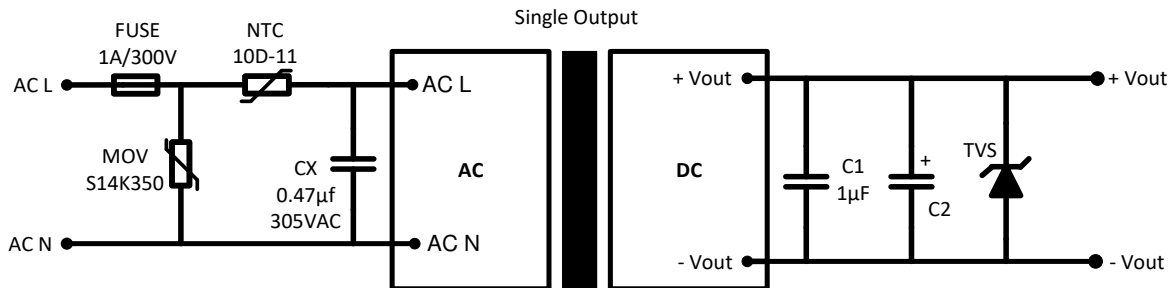

Model	C2(µF)	TVS
AMEL2-3.3S277NZ	330	SMBJ7A
AMEL2-5S277NZ	220	SMBJ7A
AMEL2-9S277NZ	100	SMBJ12A
AMEL2-12S277NZ	100	SMBJ20A
AMEL2-15S277NZ	100	SMBJ20A
AMEL2-24S277NZ	100	SMBJ30A

EMC Recommended Circuit

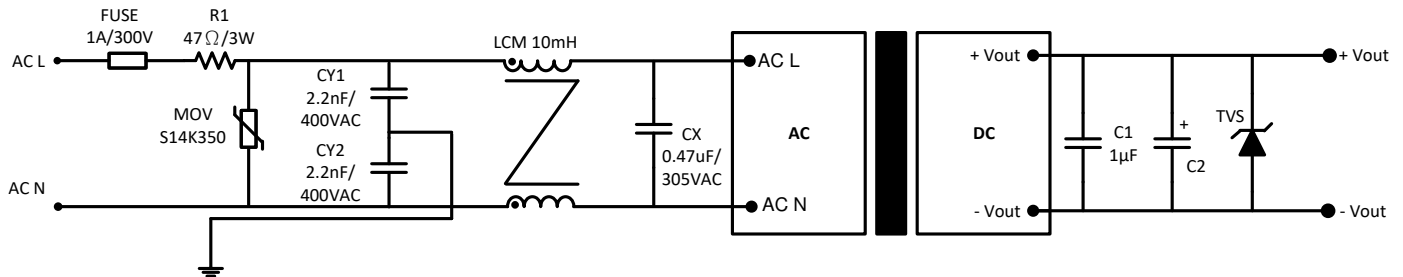

Dimensions

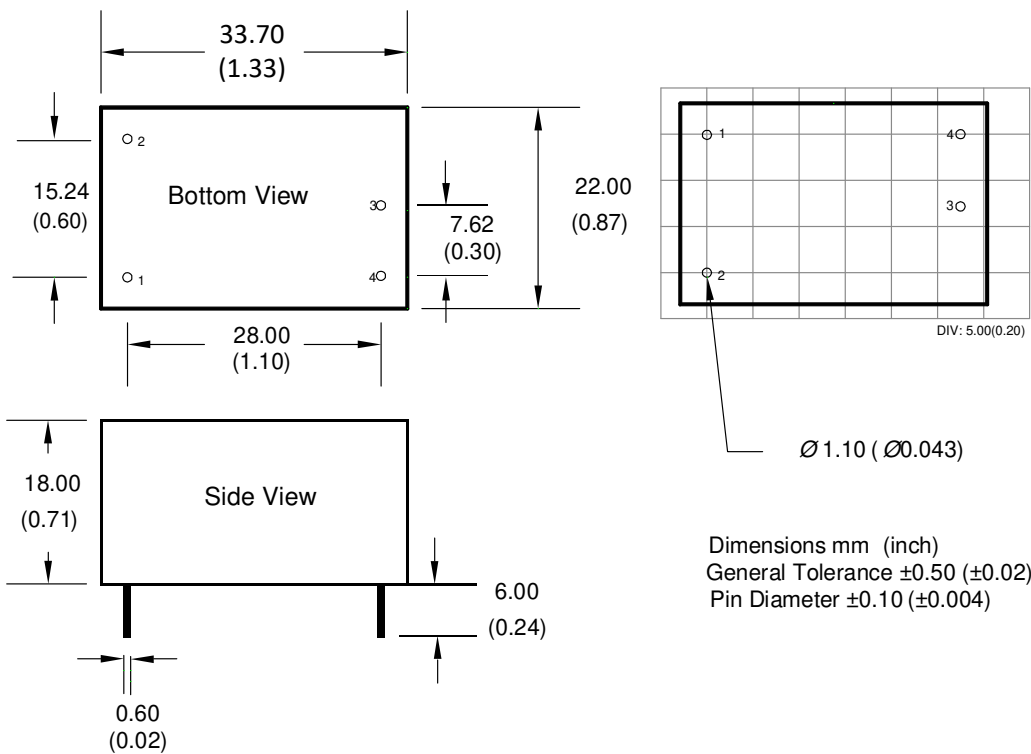

Pin Output Specifications	
Pin	Function
1	Input (N)
2	Input (L)
3	+V Output
4	-V Output

Dimensions with ST Optional

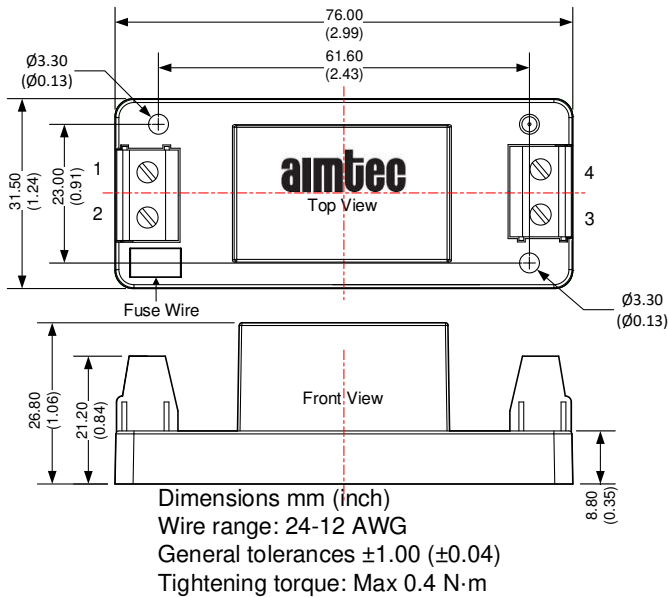

Pin Output Specifications	
Pin	Function
1	Input (N)
2	Input (L)
3	-V Output
4	+V Output

Dimensions with STD Optional

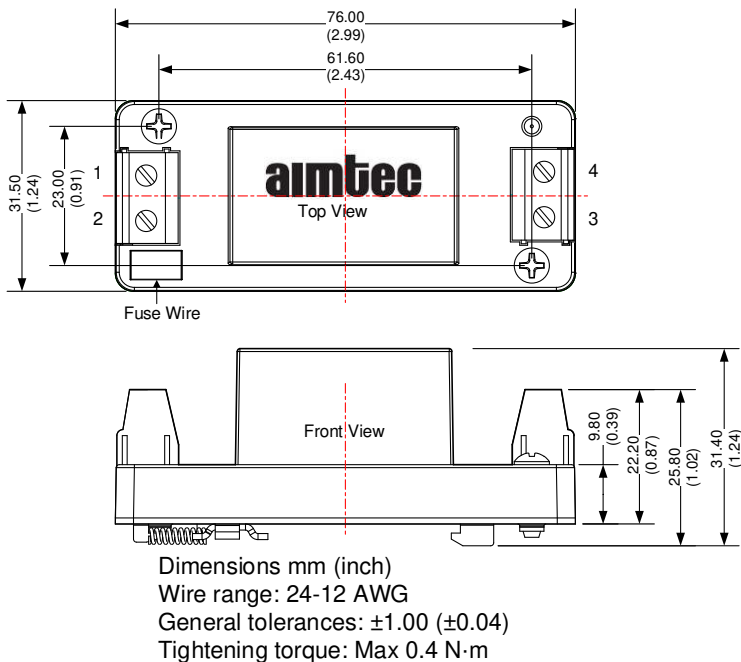

Pin Output Specifications	
Pin	Function
1	Input (N)
2	Input (L)
3	-V Output
4	+V Output

NOTE: 1. Datasheets are updated as needed and as such, specifications are subject to change without notice. Once printed or downloaded, datasheets are no longer controlled by Aimtec; refer to www.aimtec.com for the most current product specifications. 2. Product labels shown, including safety agency certifications on labels, may vary based on the date manufactured. 3. Mechanical drawings and specifications are for reference only. 4. All specifications are measured at an ambient temperature of 25°C, humidity < 75%, nominal input voltage and at rated output load unless otherwise specified. 5. Aimtec may not have conducted destructive testing or chemical analysis on all internal components and chemicals at the time of publishing this document. CAS numbers and other limited information are considered proprietary and may not be available for release. 6. This product is not designed for use in critical life support systems, equipment used in hazardous environments, nuclear control systems or other such applications which necessitate specific safety and regulatory standards other than the ones listed in this datasheet. 7. Warranty is in accordance with Aimtec's standard Terms of Sale available at www.aimtec.com.