

IB IL 24/230 DOR 1/W ...

Inline Terminal With One SPDT Relay Contact

AUTOMATIONWORX

Data Sheet
6774_en_00

© PHOENIX CONTACT - 03/2007

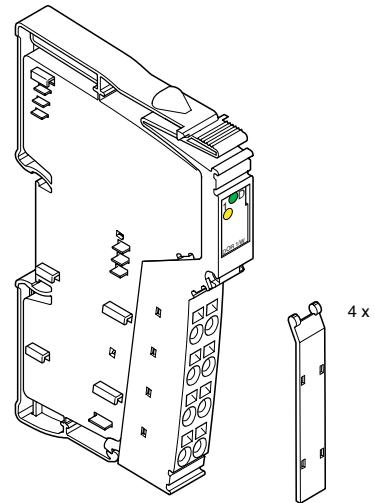

Description

The terminal is designed for use within an Inline station. It has a floating SPDT relay contact.



The terminal can be used in the SELV area and in the AC area. Observe the appropriate regulations and safety notes when using the terminal in the AC area.

Features

- Safe isolation according to EN 50178
- Floating connection for one actuator
- Nominal current at the output: 3 A
- Total current of the terminal: 3 A
- Diagnostic and status indicators



This data sheet is only valid in association with the IL SYS INST UM E user manual or the Inline system manual for your bus system.



Make sure you always use the latest documentation.
It can be downloaded at www.download.phoenixcontact.com.
A conversion table is available on the Internet at
www.download.phoenixcontact.com/general/7000_en_00.pdf.



This data sheet is valid for all products listed on the following page:

Ordering Data

Products

Description	Type	Order No.	Pcs./Pck.
Inline terminal with one digital relay output; without accessories transmission speed of 500 kbps	IB IL 24/230 DOR 1/W	2836434	1
Inline terminal with one digital relay output; complete with accessories (connector and labeling field); transmission speed of 500 kbps	IB IL 24/230 DOR 1/W-PAC	2861881	1
Inline terminal with one digital relay output; without accessories transmission speed 2 Mbps	IB IL 24/230 DOR 1/W-2MBD	2855910	1
Inline terminal with one digital relay output; complete with accessories (connector and labeling field); transmission speed 2 Mbps	IB IL 24/230 DOR 1/W-2MBD-PAC	2862110	1



One of the listed connectors is needed for the complete fitting of the terminals IB IL 24/230 DOR 1/W and IB IL 24/230 DOR 1/W-2MBD.

Accessories

Description	Type	Order No.	Pcs./Pck.
Plug, for digital 1, 2 or 8-channel Inline terminals with AC voltage	IB IL SCN-8-AC-REL	2740290	1
Inline spacer terminal block, without accessories	IB IL DOR LV-SET	2742641	1
Connector set for spacer terminal block	IB IL DOR LV-PLSET	2742667	1

Documentation

Description	Type	Order No.	Pcs./Pck.
"Configuring and Installing the INTERBUS Inline Product Range " user manual	IB IL SYS PRO UM E	2743048	1
"Automation Terminals of the Inline Product Range" user manual	IL SYS INST UM E	2698737	1

Technical Data

General Data	
Housing dimensions (width x height x depth)	12.2 mm x 120 mm x 71.5 mm
Weight	46 g (without connector), 61 g (with connector)
Operating mode	Process data mode with 2 bits
Connection method for actuators	At a floating SPDT relay contact
Ambient temperature (operation)	-25°C to +55°C
Ambient temperature (storage/transport)	-25°C to +85°C
Permissible humidity (operation/storage/transport)	10% to 95% according to DIN EN 61131-2
Permissible air pressure (operation)	80 kPa to 106 kPa (up to 2000 m above sea level)
Permissible air pressure (storage/transport)	70 kPa to 106 kPa (up to 3000 m above sea level)
Degree of protection	IP20 according to IEC 60529
Connection data for Inline connector	
Connection method	Spring-cage connection
Conductor cross-section	0.2 mm ² to 1.5 mm ² (solid or stranded), 24 - 16 AWG
Interface	
Local bus	Through data routing

Transmission Speed

IB IL 24/230 DOR 1/W, IB IL 24/230 DOR 1/W-PAC	500 kbps
IB IL 24/230 DOR 1/W-2MBD, IB IL 24/230 DOR 1/W-2MBD-PAC	2 Mbps

Power Consumption

	500 kbps	2 Mbps
Communications power	7.5 V DC	7.5 V DC
Current consumption at U_L	60 mA, maximum	90 mA, maximum
Power consumption at U_L	0.45 W, maximum	0.675 W, maximum

Supply of the Module Electronics and I/O Through Bus Coupler/Power Terminal

Connection method	Through potential routing
-------------------	---------------------------

Relay Output

Number	1
Contact material	AgSnO ₂ , hard gold-plated
Contact resistance	50 mΩ at 100 mA/6 V
Limiting continuous current (at maximum ambient temperature)	3 A
Maximum switching voltage	253 V AC, 250 V DC
Maximum switching power (AC/DC)	750 VA (see derating)
Minimum load	5 V; 10 mA
Switching current at 30 V DC	3 A
Switching current at 250 V DC	0.15 A
Switching current at 253 V AC	3 A
Maximum inrush current peak for lamp loads and capacitive loads	6 A for T = 200 μs



See also Table "Maximum Switching Current for Ohmic Load Depending on the Switching Voltage" on page 4.

Nominal power consumption of the coil (at 20°C)	210 mW from the 7.5 V supply
Resistance of the coil (at 20°C)	119 Ω ±12 Ω
Maximum switching frequency (without load)	1200 cycles/minute
Maximum switching frequency (with nominal load)	6 cycles/minute
Response delay	5 ms, typical
Bouncing time	5 ms, typical
Release time	6 ms, typical
Mechanical service life	2 x 10 ⁷ cycles
Electrical service life	10 ⁵ cycles (at 20 cycles/minute)
Common potentials	All contacts floating

Maximum Switching Current for Ohmic Load Depending on the Switching Voltage

Switching Voltage (V DC)	Switching Current (A)
10	3.0
20	3.0
30	3.0
40	1.0
50	0.4
60	0.3
70	0.26
80	0.23
90	0.215
100	0.2
150	0.18
200	0.165
250	0.155

Load Current (I_L in A) as a Function of the Switching Voltage (U_{switch} in V)

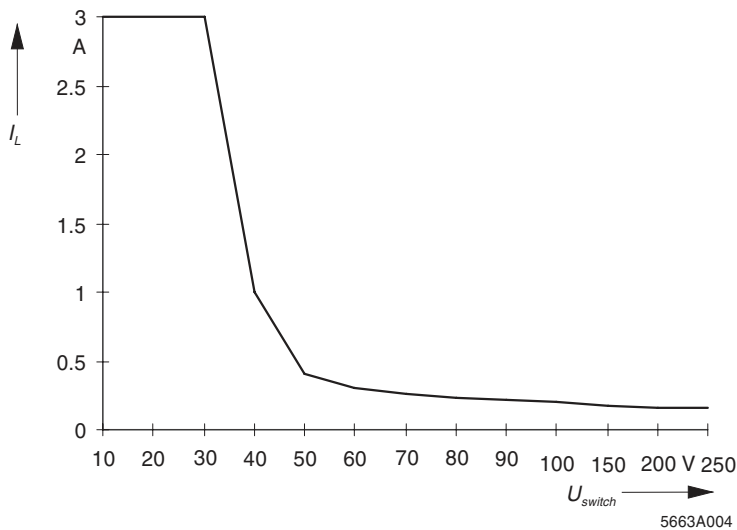

Power Dissipation

500 kbps **2 Mbps**

Formula to Calculate the Power Dissipation in the Terminal

$P_{TOT} = P_{BUS} + (P_{REL}) + P_L$	$P_{TOT} = P_{BUS} + (P_{REL}) + P_L$
$P_{TOT} = 0.19 \text{ W} + (0.26 \text{ W}) + I_L^2 \times 0.05 \Omega$	$P_{TOT} = 0.33 \text{ W} + (0.26 \text{ W}) + I_L^2 \times 0.05 \Omega$



For an N/C contact, the term P_{REL} is omitted from the formula.

- Where
- P_{TOT} Total power dissipation in the terminal
 - P_{BUS} Power dissipation through bus operation
 - P_{REL} Power dissipation of the relay coil
 - P_L Power dissipation through the load current via the contacts
 - I_L Load current of the output

Power Dissipation of the Housing Depending on the Ambient Temperature

$$P_{\text{HOU}} = 1.2 \text{ W} \quad -25^{\circ}\text{C} (-13^{\circ}\text{F}) < T_{\text{A}} \leq +25^{\circ}\text{C} (+77^{\circ}\text{F})$$

$$P_{\text{HOU}} = 1.2 \text{ W} - (T_{\text{A}} - 25^{\circ}\text{C} [77^{\circ}\text{F}]) \times 0.02 \text{ W}^{\circ}\text{C} \quad +25^{\circ}\text{C} < T_{\text{A}} [+77^{\circ}\text{F}] \leq +55^{\circ}\text{C} (+131^{\circ}\text{F})$$

P_{HOU} Power dissipation of the housing
 T_{A} Ambient temperature

Derating When Using the N/O Contact**(500 kbps and 2 Mbps)**

Ambient Temperature T_{A}	Power Dissipation of the Housing	Maximum Load Current
40°C	0.9 W	3.0 A
45°C	0.8 W	2.6 A
50°C	0.7 W	2.2 A
55°C	0.6 W	1.7 A

With an ambient temperature of up to 40°C, a maximum permissible load current of 3.0 A can flow via the N/O contact. Observe the derating at higher temperatures.

Safety Equipment

None

Error Messages to the Higher-Level Control or Computer System

None

Air and Creepage Distances (According to EN 50178, VDE 0109, VDE 0110)

Isolating Distance	Clearance	Creepage Distance	Test Voltage
Relay contact/bus logic	≥ 5.5 mm	≥ 5.5 mm	4 kV, 50 Hz, 1 min.
Contact/contact	≥ 3.1 mm	≥ 3.1 mm	1 kV, 50 Hz, 1 min.
Contact/PE	≥ 3.1 mm	≥ 3.1 mm	1 kV, 50 Hz, 1 min.

Approvals

For the latest approvals, please visit www.download.phoenixcontact.com.

Safety Notes for Inline Terminals Used in Areas Outside the SELV Area (AC Area)



Only qualified personnel may work on Inline terminals in the AC area.

Qualified personnel are persons who, because of their education, experience and instruction, and their knowledge of relevant standards, regulations, accident prevention, and service conditions, have been authorized by those responsible for the safety of the plant to carry out any required operations, and who are able to recognize and avoid any possible dangers.

(Definition of skilled workers according to EN 50110-1: 1996).



The instructions given in the IB IL SYS PRO UM E user manual and in this data sheet must be strictly observed during installation and startup.

Technical modifications reserved.

Correct Usage

The terminal is only to be used within an Inline station as specified in this data sheet and in the "Configuring and Installing the INTERBUS Inline Product Range" user manual. Phoenix Contact accepts no liability if the device is used for anything other than its designated use.



Dangerous contact voltage

Please note that there are dangerous contact voltages when switching circuits that do not meet SELV requirements.

Only remove and insert the AC terminals when the power supply is disconnected.

When working on terminals and wiring, always switch off the supply voltage and ensure it cannot be switched on again.

Installation Instructions and Notes



Install the system according to the requirements of EN 50178.



Use grounded AC networks

Inline AC terminals must only be operated in grounded AC networks.



Read the application description

Observe the installation instructions and notes in the IB IL SYS PRO UM E manual, especially the notes on the low voltage area.

Special Features of the Terminal

The terminal can be used to switch loads up to 230 V.



Please note that the terminal interrupts the potential jumpers UM, US, and GND (24 V area) as well as L and N (120 V/230 V areas). If required, these supply voltages must be resupplied/provided using an appropriate power terminal after the relay terminal.

Switching Loads in the 230 V Area

To switch voltages outside the SELV area, an AC area must be created according to the installation instructions and notes provided in the application description.



Operation on an AC network

Operate the terminal from a single phase on an AC network.

Switching Voltages That Are Not Available in the Segment

A relay terminal can be used to switch voltages that are not available in the segment in which the terminal is located (e.g., switching 230 V AC within a 24 V DC segment). In this case, place a distance terminal before and after the terminal. The isolating distances between the individual areas are thus maintained.

See also "Connection Examples" on page 9.

Local Diagnostic and Status Indicators and Terminal Point Assignment

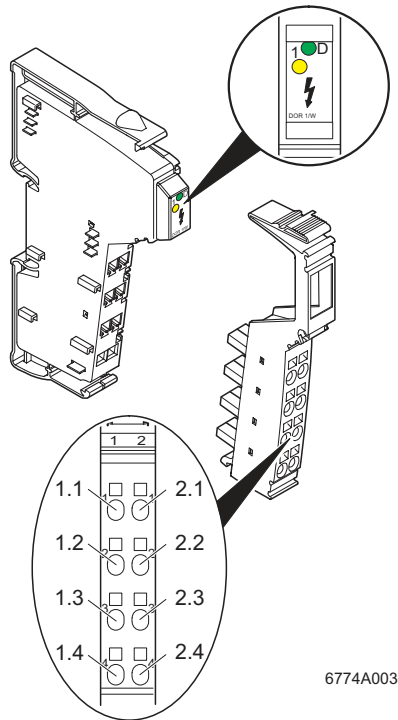

Figure 1 Terminal with appropriate connector

Local Diagnostic and Status Indicators

Des.	Color	Meaning
D	Green	Diagnostics
1	Yellow	Status indicator of the output (relay has picked up)

Function Identification

Red with lightning bolt

2 Mbps: White stripe in the vicinity of the D LED

Housing/Connector Color

Dark gray housing

Dark gray connector, without color print

Terminal Point Assignment

Terminal Points	Assignment
1.1, 2.1	Not used (no contact present)
1.2, 2.2	Relay N/C contact
1.3, 2.3	Relay main contact
1.4, 2.4	Relay N/O contact

Adjacent contacts 1.2/2.2, 1.3/2.3, and 1.4/2.4 are jumpered in the corresponding IB IL SCN-8-AC connector. It is therefore possible to supply several relays of the terminals by using a jumper to transmit the voltage from one terminal to the next.



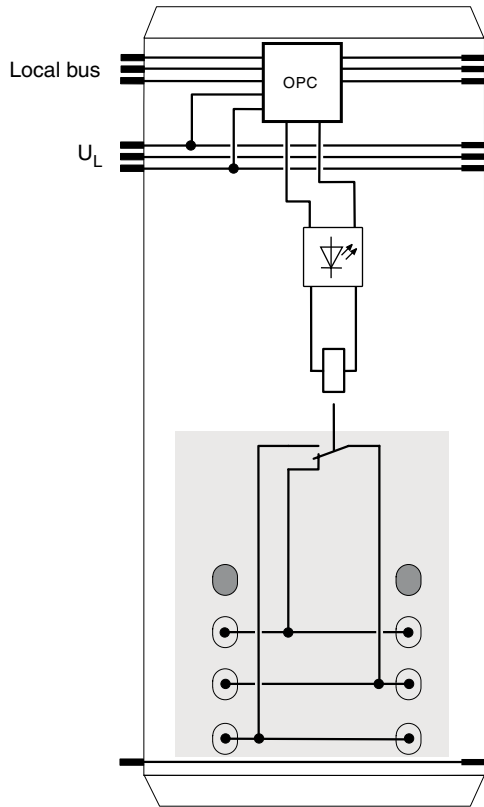

Internal Circuit Diagram



7376C010

Figure 2 Internal wiring of the terminal points

Key:

-  Protocol chip (bus logic including voltage conditioning)
-  LED
-  Terminal point, without metal contact
-  Relay
-  Electrically isolated area
I/O area including relay contact isolated from the logic area including the relay coil through "safe isolation" according to EN 50178



Other symbols used are explained in the IL SYS INST UM E user manual or in the Inline system manual for your bus system.

Connection Examples

Connection of an Actuator

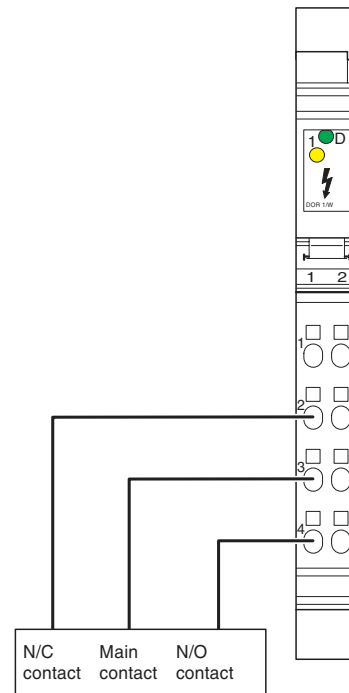

5663A008

Figure 3 Typical connection of an actuator

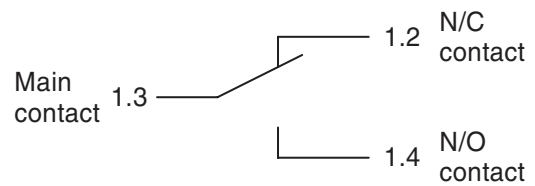

5663A009

Figure 4 Output relay contacts

Switching Voltages That Are Not Available in the Segment

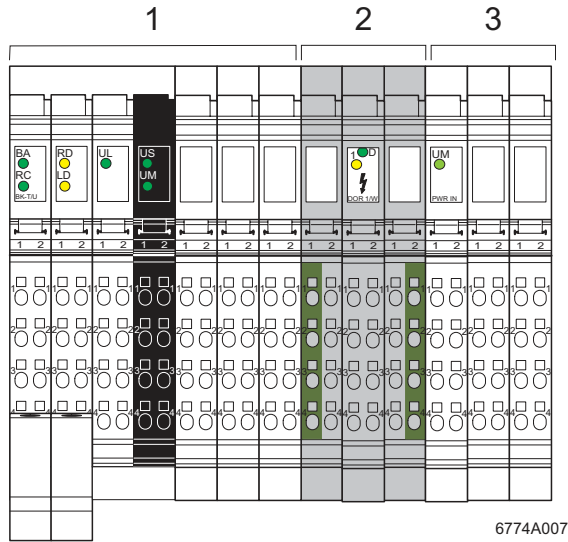

Figure 5 Example: Switching 230 V AC within a 24 V DC area

- 1 24 V DC area consisting of bus coupler and I/O terminals
- 2 Terminal separated from the 24 V area by distance terminals
- 3 24 V area consisting of a power terminal and I/O terminals

See also "Special Features of the Terminal" on page 7.



Also insert distance terminals if you want to switch a 24 V channel within a 230 V AC area.

Switching Voltages That Are Available in the Segment



Distance terminals are not required to switch a 24 V channel within a 24 V area or to switch a 230 V channel within a 230 V area.

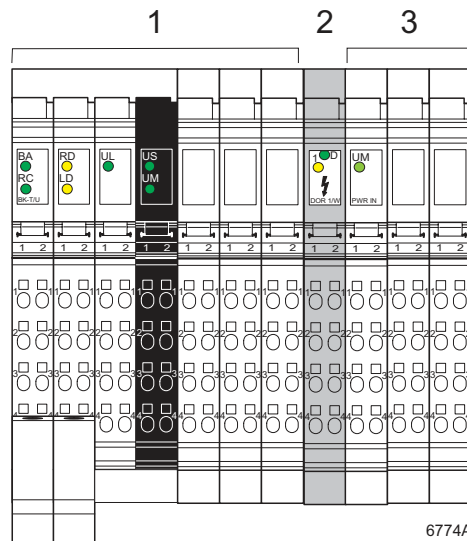

Figure 6 Switching 24 V within a 24 V area

- 1 24 V area consisting of bus coupler and I/O terminals
- 2 Terminal
- 3 24 V area consisting of a power terminal and I/O terminals

Interference Suppression Measures on Inductive Loads/Switching Relays

Each electrical load is a mix of ohmic, capacitive, and inductive elements. Depending on the proportion of the elements, switching these loads results in a larger or smaller load on the switch contact.

In practice, loads are generally used with a large inductive element, such as contactors, solenoid valves or motors. Due to the energy stored in the coils, voltage peaks of up to a few thousand volts may occur when the system is switched off. These high voltages cause an arc on the controlling contact, which may destroy the contact through material vaporization and material migration.

This pulse, which is similar to a square wave pulse, emits electromagnetic pulses over a wide frequency range (spectral elements reaching several MHz) with a large amount of power.

To prevent such arcs from occurring, the contacts/loads must be fitted with protective circuits. In general, the following protective circuits can be used:

- Contact protective circuit
- Load protective circuit
- Combination of both protective circuits

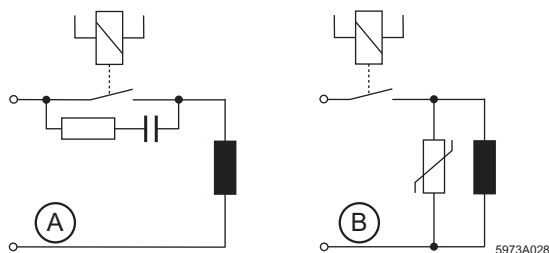

Figure 7 Contact protective circuit (A), load protective circuit (B)

If sized correctly, these circuit versions do not differ greatly in their effectiveness. In principle, safety equipment should intervene directly at the source of the interference. The following points speak in favor of a load protective circuit:

- When the contact is open, the load is electrically isolated from the operating voltage.
- It is not possible for the load to be activated or to "stick" due to undesired operating currents, e.g., from RC elements.
- Shutdown voltage peaks cannot be coupled in control lines that run in parallel.

Today, the majority of contactor manufacturers offer diode, RC or varistor elements that can be snapped on. For solenoid valves, connectors with an integrated protective circuit can be used.

Circuit Versions

Protecting the Load	Additional Delay	Defined Induced Voltage Limitation	Bipolar Effective Attenuation	Advantages/Disadvantages
<p>Diode</p>	Long	Yes (U_D)	No	<p>Advantages:</p> <ul style="list-style-type: none"> - Easy implementation - Cost-effective - Reliable - Non-critical sizing - Low induced voltage <p>Disadvantages:</p> <ul style="list-style-type: none"> - Attenuation only via load resistor - Long delay
<p>Series connection diode/ Zener diode</p>	Medium to short	Yes (U_{ZD})	No	<p>Advantages:</p> <ul style="list-style-type: none"> - Non-critical sizing <p>Disadvantages:</p> <ul style="list-style-type: none"> - Attenuation only above U_{ZD}
<p>Suppressor diode</p>	Medium to short	Yes (U_{ZD})	Yes	<p>Advantages:</p> <ul style="list-style-type: none"> - Cost-effective - Non-critical sizing - Limits positive peaks - Suitable for AC voltage <p>Disadvantages:</p> <ul style="list-style-type: none"> - Attenuation only above U_{ZD}
<p>Varistor</p>	Medium to short	Yes (U_{VDR})	Yes	<p>Advantages:</p> <ul style="list-style-type: none"> - High power absorption - Non-critical sizing - Suitable for AC voltage <p>Disadvantages:</p> <ul style="list-style-type: none"> - Attenuation only above U_{VDR}

5663A029

RC Circuit Versions

RC Series Circuit:

Protecting the Load	Additional delay	Defined Induced Voltage Limitation	Bipolar Effective Attenuation	Advantages/Disadvantages
<p>R/C combination</p>	Medium to short	No	Yes	<p>Advantages:</p> <ul style="list-style-type: none"> - HF attenuation via power store - Suitable for AC voltage - Level-independent attenuation - Reactive-current compensating <p>Disadvantages:</p> <ul style="list-style-type: none"> - Exact sizing required - High inrush current

5663A030

Sizing:

- Capacitor: $C \approx L_{Load}/4 \times R_{Load}^2$
- Resistor: $R \approx 0.2 \times R_{Load}$

RC Parallel Circuit With Series Diode

Protecting the Load	Additional delay	Defined Induced Voltage Limitation	Bipolar Effective Attenuation	Advantages/Disadvantages
<p>R/C combination with diode</p>	Medium to short	No	Yes	<p>Advantages:</p> <ul style="list-style-type: none"> - HF attenuation via power store - Level-independent attenuation - Current inversion not possible <p>Disadvantages:</p> <ul style="list-style-type: none"> - Exact sizing required - Only suitable for DC voltage

5663A031

Sizing:

- Capacitor: $C \approx L_{Load}/4 \times R_{Load}^2$
- Resistor: $R \approx 0.2 \times R_{Load}$

Switching AC/DC Loads

Switching Large AC Loads

When switching large AC loads, the relay can be operated up to the corresponding maximum values for the switching voltage, current, and power. The arc that occurs during shutdown depends on the current, voltage, and phase relation. This shutdown arc switches off automatically the next time the load current passes through zero.

In applications with an inductive load, an effective protective circuit must be provided, otherwise the service life of the system will be reduced considerably.

To prolong the life of the terminal as much as possible when using lamp loads or capacitive loads, the current peak must not exceed 6 A when the load is switched on.

Switching Large DC Loads

In DC operation, a relay can only switch a relatively low current compared with the maximum permissible alternating current. This maximum DC value is also highly dependent on the voltage and is determined in part by design conditions, such as the contact distance and contact opening speed.

The corresponding current and voltage values are shown using the example in Figure 8.

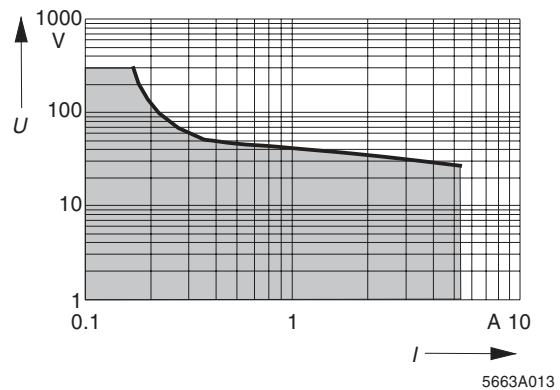

Figure 8 DC load limit curve (REL-SNR-1XU/G 5 GOLD LIEG relay)

- I* Switching current in A
- U* Switching voltage in V

Definition of the load limit curve: For 1000 cycles, no constant arc should occur with a burning life > 10 ms.

A non-attenuated inductive load further reduces the values for switching currents given here. The energy stored in the inductance can cause an arc to occur, which forwards the current via the open contacts. Using an effective contact protection circuit, virtually the same currents can be switched as for an ohmic load and the service life of the relay contacts is the same.

If it is permitted to switch higher DC loads, several relay contacts can be switched in parallel.

The technical data for this is available on request.

Programming Data

Local Bus (INTERBUS)

ID code	BD _{hex} (189 _{dec})
Length code	C2 _{hex}
Process data channel	2 bits
Input address area	0 bits
Output address area	2 bits (only bit 0 is occupied)
Parameter channel (PCP)	0 bits
Register length (bus)	2 bits

Other Bus Systems



For the programming data/configuration data of other bus systems, please refer to the corresponding electronic device data sheet (e.g., GSD, EDS).

Process Data

Assignment of the Terminal Points to the OUT Process Data

(Byte.Bit) view	Bit	0.1	0.0
Terminal	N/C contact	–	1.2
	Main contact	–	1.3
	N/O contact	–	1.4
Status indicator	LED		1

If bit 0.0 is set to 1, the N/O contact is closed.

The LED lights up if the N/O contact is closed.

© PHOENIX CONTACT 03/2007