

MATERIALS AND FINISHES

BODY, CRIMP TUBE, C'NUT BRASS
PLATED SEE TABLE

CENTER CONTACT BRASS
PLATED GOLD

INSULATOR, SPACER TEFLON

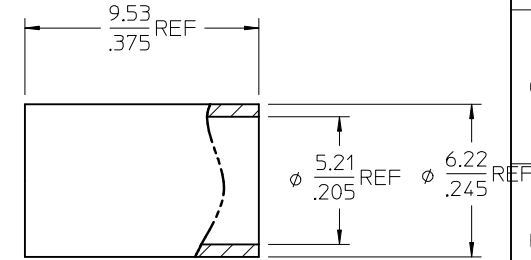
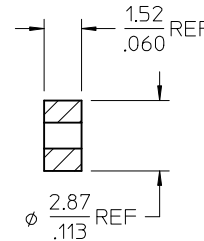
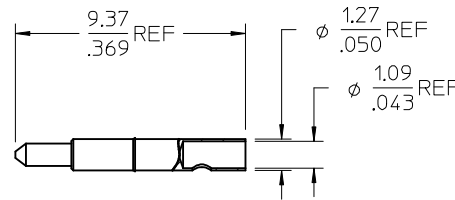
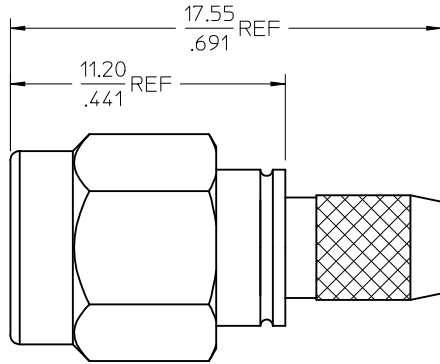
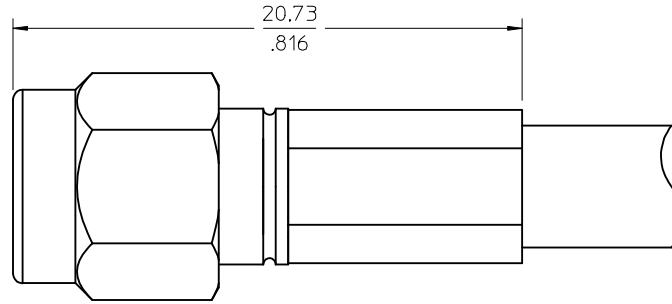
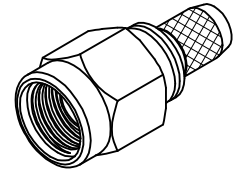

CONTACT

SPACER

CRIMP TUBE

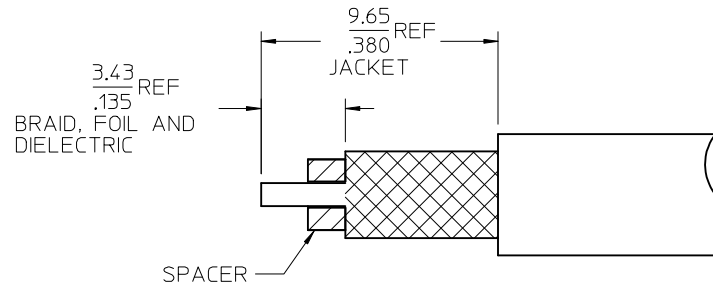

RECOMMENDED STRIPPING DIMENSIONS
CRIMP HEX SIZE 5.41(.213)

73251-1631	GOLD
73251-1630	NICKEL
PART NO.	PLATING

MIL-STD-348A, FIG. 310.1	INTERFACE
SPECIFICATION	DESCRIPTION

CHG: STRIP DIM WAS
1.91 REF DIELECTRIC,
2.16 REF FOIL AND
3.43 BRAID. ADDED
SPACER. REMOVED
AS-89678-770
EC NO: URF-2008-0052
DRW:SSSHAH 2007/07/27
CHKD:FLAHERY 2007/07/27
APPR:JWENER 2007/07/27

QUALITY SYMBOLS

 DESCRIPTION
 REV: A3

GENERAL TOLERANCES (UNLESS SPECIFIED)

	mm	INCH
4 PLACES	± .005	± .0002
3 PLACES	± .003	± .0001
2 PLACES	± .002	± .00005
1 PLACE	± .001	± .00002

ANGULAR ± 2°
 DRAFT WHERE APPLICABLE
 MUST REMAIN
 WITHIN DIMENSIONS

DIMENSION STYLE
MM/IN

DRAWN BY: SSS DATE: 2001/08/02
 CHECKED BY: TEF DATE: 2001/08/02
 APPROVED BY: GMH DATE: 2001/08/02

MATERIAL NO. SEE TABLE
 SIZE: C

SCALE: METRIC
 DESIGN UNITS: METRIC
 THIRD ANGLE PROJECTION

TITLE: SMA PLUG, STR
 50 OHMS, BELDEN 7806R
 SMA-PC

MOLEX INCORPORATED
 DOCUMENT NO. SD-73251-163
 SHEET NO. 1 OF 1

THIS DRAWING CONTAINS INFORMATION THAT IS PROPRIETARY TO MOLEX INCORPORATED AND SHOULD NOT BE USED WITHOUT WRITTEN PERMISSION

MATERIALS AND FINISHES

BODY, CRIMP TUBE, C'NUT BRASS
PLATED SEE TABLE

CENTER CONTACT BRASS
PLATED GOLD

INSULATOR, SPACER TEFLON

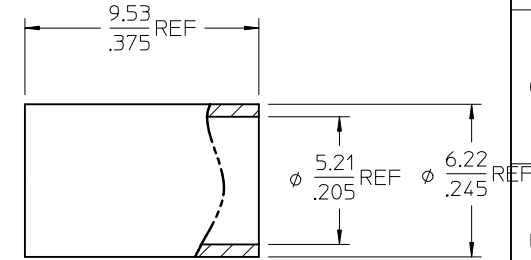
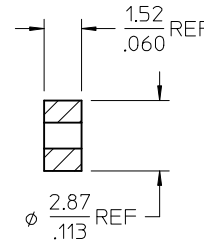
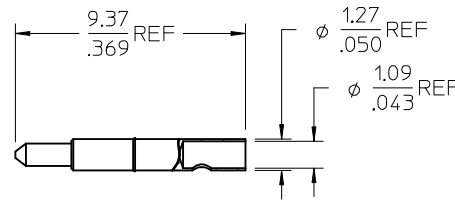
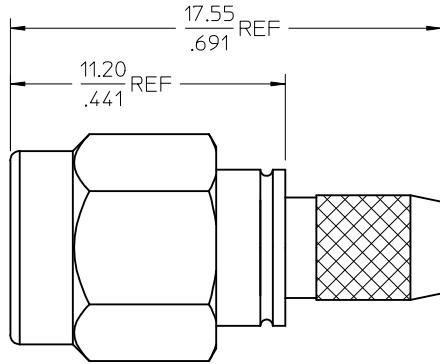
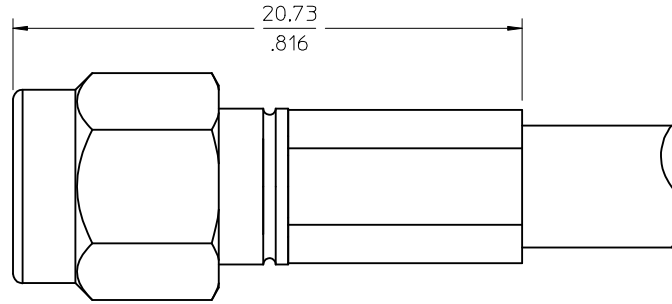
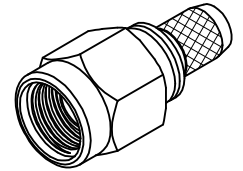

CONTACT

SPACER

CRIMP TUBE

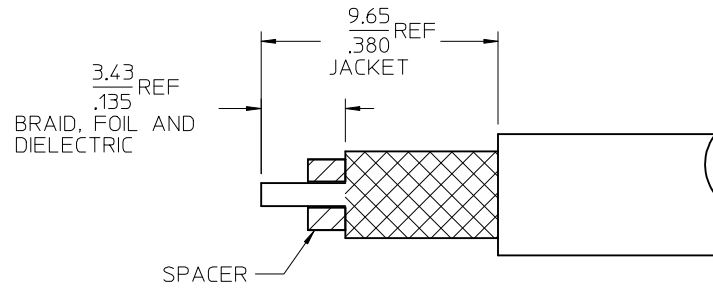

RECOMMENDED STRIPPING DIMENSIONS
CRIMP HEX SIZE 5.41(.213)

73251-1631	GOLD
73251-1630	NICKEL
PART NO.	PLATING

MIL-STD-348A, FIG. 310.1	INTERFACE
SPECIFICATION	DESCRIPTION

CHG: STRIP DIM WAS
1.91 REF DIELECTRIC,
2.16 REF FOIL AND
3.43 BRAID. ADDED
SPACER. REMOVED
AS-89678-770
EC NO: URF-2008-0052
DRW:SSSHAH 2007/07/27
CHKD:FLAHERY 2007/07/27
APPR:JWENER 2007/07/27

QUALITY SYMBOLS

 DESCRIPTION
 REV: A3

GENERAL TOLERANCES (UNLESS SPECIFIED)

	mm	INCH
4 PLACES	± .005	± .0005
3 PLACES	± .003	± .0003
2 PLACES	± .002	± .0002
1 PLACE	± .001	± .0001

ANGULAR ± 2 °
 DRAFT WHERE APPLICABLE
 MUST REMAIN
 WITHIN DIMENSIONS

DIMENSION STYLE
MM/IN

DRAWN BY	DATE
SSS	2001/08/02
CHECKED BY	DATE
TEF	2001/08/02
APPROVED BY	DATE
GMH	2001/08/02

MATERIAL NO.
SEE TABLE
 SIZE
C

SCALE
DESIGN UNITS
METRIC

THIRD ANGLE PROJECTION

TITLE
SMA PLUG, STR
50 OHMS, BELDEN 7806R
SMA-PC

MOLEX INCORPORATED
 DOCUMENT NO. SD-73251-163
 SHEET NO. 1 OF 1

THIS DRAWING CONTAINS INFORMATION THAT IS PROPRIETARY TO MOLEX INCORPORATED AND SHOULD NOT BE USED WITHOUT WRITTEN PERMISSION