



# AK6416C

## 16Kbit Serial CMOS EEPROM

### Features

- ADVANCED CMOS EEPROM TECHNOLOGY
- READ/WRITE NON-VOLATILE MEMORY
  - Wide VCC (1.8V to 5.5V) operation
  - 16384 bits: 1024 × 16 organization
- ONE CHIP MICROCOMPUTER INTERFACE
  - Interface with one chip microcomputer's serial communication port directly
- LOW POWER CONSUMPTION
  - 0.8μA Max. (Standby mode)
- HIGH RELIABILITY
  - Endurance : 1000K cycles/Address
  - Data Retention : 10 years
- SPECIAL FEATURES
  - 8 word Page Write Mode
  - High speed operation ( f<sub>MAX</sub>=5MHz: VCC=4.5V to 5.5V )
  - Automatic write cycle time-out with auto-ERASE(5ms Max.)
  - Automatic address increment (READ)
  - Ready/ Busy status signal
  - Software and Hardware controlled write protection
- IDEAL FOR LOW DENSITY DATA STORAGE
  - Low cost, space saving, 8-pin package (SSOP, MSOP)

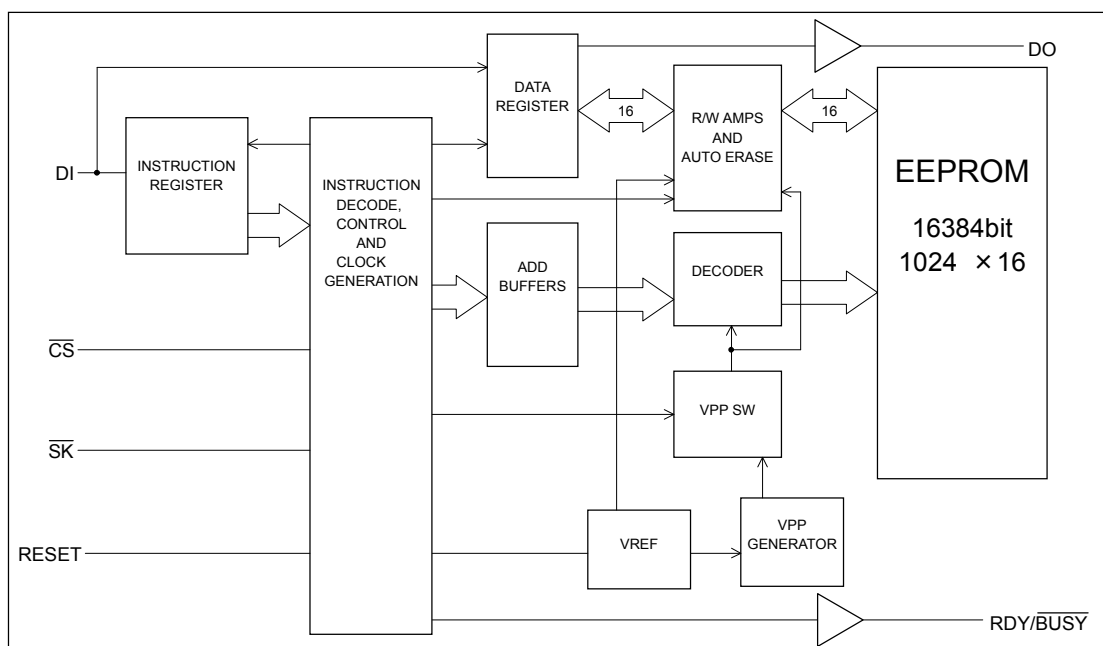

Block diagram

General Description
---------------------

The AK6416C is a 16384bit, serial, read/write, non-volatile memory device fabricated using an advanced CMOS EEPROM technology. The AK6416C has 16384bits of memory organized into 1024 registers of 16 bits each. The AK6416C can operate full function under wide operating voltage range from 1.8V to 5.5V. The charge up circuit is integrated for high voltage generation that is used for write operation.

The AK6416C can connect to the serial communication port of popular one chip microcomputer directly (3 line negative clock synchronous interface). At write operation, AK6416C takes in the write data from data input pin (DI) to a register synchronously with rising edge of input pulse of serial clock pin (SK). And at read operation, AK6416C takes out the read data from a register to data output pin (DO) synchronously with falling edge of SK.

The AK6416C has 5 instructions such as READ, WRITE, PAGE WRITE, WREN (write enable) and WRDS (write disable). Each instruction is organized by op-code block (8bits), address block (8bits) and data (8bits x 2). When input level of SK pin is high level and input level of chip select (CS) pin is changed from high level to low level, AK6416C can receive the instructions.

Special features of the AK6416C include : automatic write time-out with auto-ERASE, Ready/ Busy status signal output and ultra-low standby power mode when deselected (CS =high).

• Software and Hardware controlled write protection

The AK6416C has 2 (hardware and software) write protection functions.

After power on or after execution of WRDS (write disable) instruction, execution of WRITE instruction will be disabled. This write protection condition continues until WREN instruction is executed or VCC is removed from the part.

Execution of READ instruction is independent of both WREN and WRDS instructions.

Reset pin should be low level when WRITE instruction is executed. When the Reset pin is high level, the WRITE instruction is not executed.

• Ready/ Busy status signal

During the automatic write time-out period (Busy status), the AK6416C can't accept the other instructions. The AK6416C has 2 functions to know the Busy status from exterior.

The RDY/ BUSY pin indicates the Busy status regardless of the CS pin status. The RDY/ BUSY pin outputs the low level regardless of the CS pin status during Busy status. Except the above status, this pin outputs high level.

Also the DO pin indicates the Busy status. When input level of SK pin is low level and input level of CS pin is changed from high level to low level, the AK6416C is in the status output mode and the DO pin indicates the Ready/ Busy status. The Ready/ Busy status outputs on DO pin until CS pin is changed from low level to high level, or first bit ("1") of op-code of next instruction is given to the part. Except when the device is in the status output mode or outputs data, the DO pin is in the high impedance state.

## ■ Type of Products

Model	Temp.Range	VCC	Package
AK6416CM	-40°C to 85°C	1.8V to 5.5V	8pin Plastic SSOP
AK6416CH	-40°C to 85°C	1.8V to 5.5V	8pin Plastic MSOP

Pin Arrangement

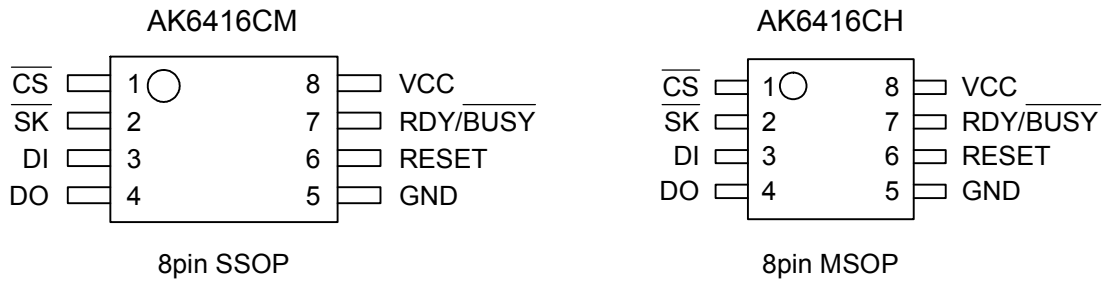

■ Pin Function

Pin name	Functions
$\overline{CS}$	Chip Select input
$\overline{SK}$	Serial Clock input
DI	Serial Data input
DO	Serial Data output
RESET	RESET input
$\overline{RDY/BUSY}$	$\overline{RDY/BUSY}$ output
VCC	Power Supply
GND	Ground

## ■ Pin Description

### $\overline{\text{CS}}$ (Chip Select)

When  $\overline{\text{SK}}$  is high level and  $\overline{\text{CS}}$  is changed from high level to low level, AK6416C can receive the instructions.  $\overline{\text{CS}}$  should be kept low level while receiving op-code, address and data and while outputting data. If  $\overline{\text{CS}}$  is changed to high level during the above period, AK6416C stops the instruction execution. When  $\overline{\text{SK}}$  is low and  $\overline{\text{CS}}$  is changed from high level to low level, AK6416C will be in status output mode. The  $\overline{\text{CS}}$  need not be low level during the automatic write time-out period (  $\overline{\text{Busy}}$  status).

### $\overline{\text{SK}}$ (Serial Clock)

The  $\overline{\text{SK}}$  clock pin is the synchronous clock input for input/output data. At write operation, AK6416C takes in the write data from data input pin (DI) synchronously with rising edge of input pulse of serial clock pin (  $\overline{\text{SK}}$  ). And at read operation, AK6416C takes out the read data to data output pin (DO) synchronously with falling edge of  $\overline{\text{SK}}$  . The  $\overline{\text{SK}}$  clock is not needed during the automatic write time-out period (  $\overline{\text{Busy}}$  status), the status output period and when the device isn't selected (  $\overline{\text{CS}}$  = high level).

### DI (Data Input)

The op-code, address and write data is input to the DI pin.

### DO (Data Output)

The DO pin outputs the read data and status signal and will be high impedance except for this timing.

### RDY/ $\overline{\text{BUSY}}$ (Ready/ $\overline{\text{Busy}}$ status)

This pin outputs the internal programming status. When the AK6416C is in the automatic write time-out period, this pin outputs the low level (  $\overline{\text{Busy}}$  status), and outputs the high level except for this timing.

### RESET (Reset)

The AK6416C stops executing the write instruction when the RESET pin is high level. The RESET pin should be low level while the write instruction input period and the page write instruction input period and the automatic write time-out period. If the RESET pin is high level while the automatic write time-out period, the AK6416C stops execution of internal programming and the device returns to ready status. In this case the word data of the specified address will be incomplete. When inputting the new instruction after RESET, the  $\overline{\text{CS}}$  pin should be set to high level. The read, write enable and write disable instructions are not affected by RESET pin status.

### VCC (Power Supply)

### GND (Ground)

Functional Description

The AK6416C has 5 instructions such as READ, WRITE, Page Write, WREN (write enable) and WRDS (write disable). Each instruction is organized by op-code block (8bits), address block (8bits) and data (8bits x 2). When input level of  $\overline{SK}$  pin is high level and input level of chip select ( $\overline{CS}$ ) pin is changed from high level to low level, AK6416C can receive the instructions. When the instructions are executed consecutively, the  $\overline{CS}$  pin should be brought to high level for a minimum of 250ns( $T_{cs}$ ) between consecutive instruction cycle.

■ Instruction Set For AK6416C

Instruction	Op-Code	Address	Data
WRITE	1 0 1 0 0 1 A9 A8	A7 A6 A5 A4 A3 A2 A1 A0	D15 – D0
Page Write	1 0 1 1 0 1 A9 A8	A7 A6 A5 A4 A3 A2 A1 A0	D15 – D0
READ	1 0 1 0 1 0 A9 A8	A7 A6 A5 A4 A3 A2 A1 A0	D15 – D0
WREN	1 0 1 0 0 0 1 1	X X X X X X X X	
WRDS	1 0 1 0 0 0 0 0	X X X X X X X X	
(WRAL)	1 0 1 0 1 1 1 1	X X X X X X X X	D15 – D0

X: don't care

(Note) The WRAL instruction is used for factory function test only. User can't use this instruction.

**Write**

The write instruction is followed by 16 bits of data to be written into the specified address. After the 32nd rising edge of  $\overline{SK}$  to read D0 in, the AK6416C will be put into the automatic write time-out period. During the automatic write time-out period ( $\overline{Busy}$  status) and while entering write instruction, the RESET pin should be low level. If the RESET pin is set to high level during the automatic write time-out period, the AK6416C stops execution of internal programming and the device returns to ready status. In this case the word data of the specified address will be incomplete. When inputting the new instruction after RESET, the  $\overline{CS}$  pin should be set to high level. When the RESET pin is kept at high level, the write is not executed. This becomes write protection function.

The  $\overline{CS}$  pin need not be high level during automatic write time-out period ( $\overline{Busy}$  status).

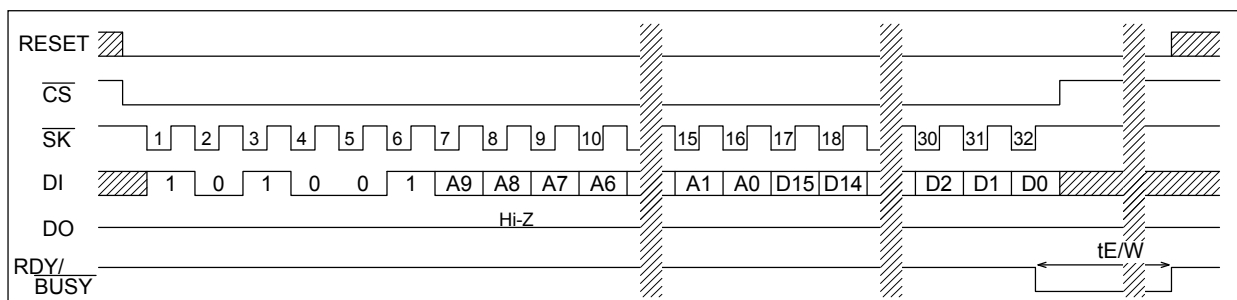

WRITE

**Page Write**

AK6416C has Page Write mode, which can write the data within 8 words with one programming cycle. The input data sent to the shift register within 8 words. After the instruction input, the internal programming cycle starts when  $\overline{CS}$  pin changes low to high. After the instructions are inputted,  $\overline{CS}$  pin should change low to high after the last data bit (D0) inputs and before next SCK clock rises. Page Write function can start only at this timing.

After the receipt of each word, the three lower order address pointer bits internally incremented by one. The higher order seven bits of the word address remains constant. When the highest address is reached "XX XXXX X111", the address counter rolls over to address "XX XXXX X000" allowing the page write cycle to be continued indefinitely.

If AK6416C is transmitted more than 8 words, the address counter will "roll over" and the previously written data will be overwritten. When AK6416C is transmitted 10 words, ninth word will be overwritten to first word, and tenth word will be overwritten to second word.

During the automatic write time-out period ( Busy status) and while entering Page Write instruction, the RESET pin should be low level. If the RESET pin is set to high level during the automatic write time-out period, the AK6416C stops execution of internal programming and the device returns to ready status. In this case the word data of the specified address will be incomplete. When inputting the new instruction after RESET, the  $\overline{CS}$  pin should be set to high level. When the RESET pin is kept at high level, the Page Write is not executed. This becomes write protection function.

The  $\overline{CS}$  pin need not be high level during automatic write time-out period ( Busy status).

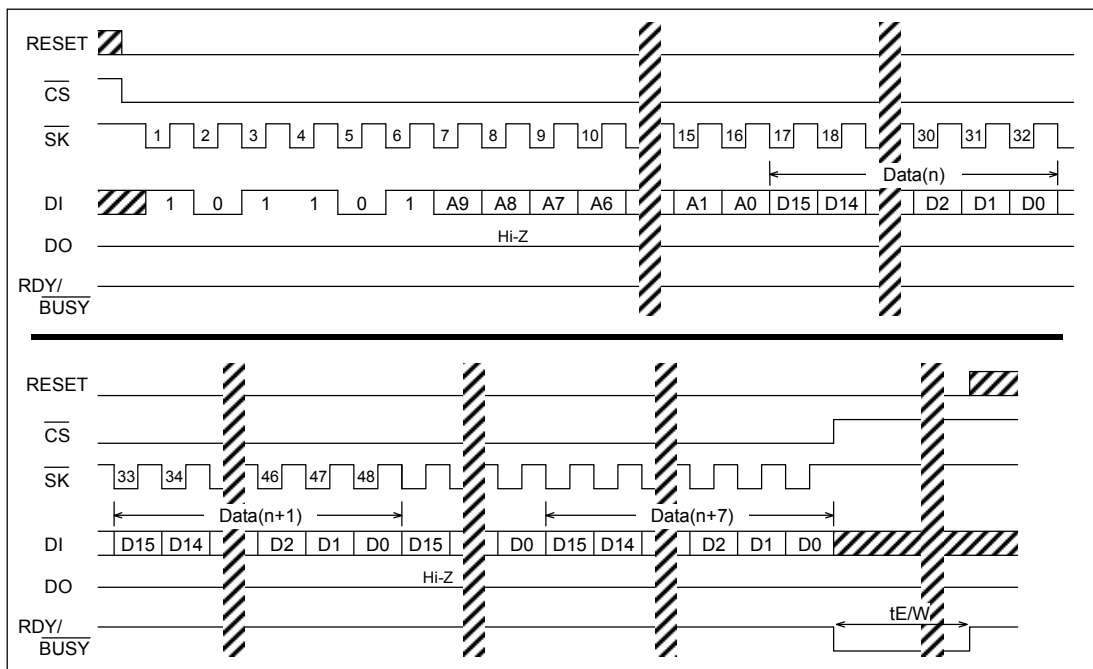

PAGE WRITE



Absolute Maximum Ratings
--------------------------

Parameter	Symbol	Min.	Max.	Unit
Power Supply	VCC	-0.6	+6.5	V
All Input Voltages with Respect to Ground	VIO	-0.6	VCC+0.6	V
Ambient storage temperature	Tst	-65	+150	°C

Stress above those listed under "Absolute Maximum Ratings" may cause permanent damage to the device. This is a stress rating only and functional operation of the device at these or any other conditions above those indicated in the operational sections of the specification is not implied. Exposure to absolute maximum conditions for extended periods may affect device reliability.

Recommended Operating Condition
---------------------------------

Parameter	Symbol	Min.	Max.	Unit
Power Supply	VCC	1.8	5.5	V
Ambient Operating Temperature	Ta	-40	+85	°C



Electrical Characteristics
----------------------------

## (1) D.C. ELECTRICAL CHARACTERISTICS

( 1.8V ≤ VCC ≤ 5.5V, -40°C ≤ Ta ≤ 85°C, unless otherwise specified )

Parameter	Symbol	Condition	Min.	Max.	Unit
Current Dissipation (WRITE)	ICC1	VCC=5.5V,tSKP=200ns *1		2.5	mA
	ICC2	VCC=2.5V,tSKP=400ns *1		2.0	mA
	ICC3	VCC=1.8V,tSKP=1.0μs *1		1.5	mA
Current Dissipation (READ,WREN, WRDS)	ICC4	VCC=5.5V,tSKP=200ns *1		1.0	mA
	ICC5	VCC=2.5V,tSKP=400ns *1		0.2	mA
	ICC6	VCC=1.8V,tSKP=1.0μs *1		0.1	mA
Current Dissipation (Standby)	ICCS	VCC=5.5V *2		0.8	μA
Input High Voltage	VIH1	2.5V ≤ VCC ≤ 5.5V	0.7×VCC	VCC+0.5	V
	VIH2	1.8V ≤ VCC < 2.5V	0.8×VCC	VCC+0.5	V
Input Low Voltage	VIL1	2.5V ≤ VCC ≤ 5.5V	0	0.3×VCC	V
	VIL2	1.8V ≤ VCC < 2.5V	0	0.2×VCC	V
Output High Voltage	VOH1	2.5V ≤ VCC ≤ 5.5V IOH=-50μA	VCC-0.3		V
	VOH2	1.8V ≤ VCC < 2.5V IOH=-50μA	VCC-0.3		V
Output Low Voltage	VOL1	2.5V ≤ VCC ≤ 5.5V IOL=1.0mA		0.4	V
	VOL2	1.8V ≤ VCC < 2.5V IOL=0.1mA		0.4	V
Input Leakage $\overline{CS}$ , $\overline{SK}$ , $\overline{DI}$ , RESET	ILI	VCC=5.5V, VIN=5.5V		±1.0	μA
Output Leakage	ILO	VCC=5.5V VOUT=5.5V, $\overline{CS}$ =VCC		±1.0	μA

\*1 : VIN=VIH/VIL, DO=RDY/  $\overline{BUSY}$  =Open\*2 :  $\overline{CS}$  =VCC,  $\overline{SK}$  / $\overline{DI}$ /RESET=VCC/GND, DO= RDY/  $\overline{BUSY}$  =Open

## (2) A.C. ELECTRICAL CHARACTERISTICS

( 1.8V ≤ VCC ≤ 5.5V, -40°C ≤ Ta ≤ 85°C, unless otherwise specified )

Parameter	Symbol	Condition	Min.	Max.	Unit
SK Cycle Time	tSKP1	4.5V ≤ VCC ≤ 5.5V	200		ns
	tSKP2	2.5V ≤ VCC < 4.5V	400		ns
	tSKP3	1.8V ≤ VCC < 2.5V	1.0		μs
SK Pulse Width	tSKW1	4.5V ≤ VCC ≤ 5.5V	100		ns
	tSKW2	2.5V ≤ VCC < 4.5V	200		ns
	tSKW3	1.8V ≤ VCC < 2.5V	500		ns
CS Setup Time	tCSS1	4.5V ≤ VCC ≤ 5.5V	40		ns
	tCSS2	1.8V ≤ VCC < 4.5V	80		ns
CS Hold Time	tCSH1	4.5V ≤ VCC ≤ 5.5V	40		ns
	tCSH2	1.8V ≤ VCC < 4.5V	80		ns
SK Setup Time	tSKSH/L1	4.5V ≤ VCC ≤ 5.5V	40		ns
	tSKSH/L2	1.8V ≤ VCC < 4.5V	80		ns
SK Hold Time	tSKH1	4.5V ≤ VCC ≤ 5.5V	40		ns
	tSKH2	1.8V ≤ VCC < 4.5V	80		ns
RESET Setup Time	tRESS		0		ns
RESET Hold Time	tRESH		0		ns
Data Setup Time	tDIS1	4.5V ≤ VCC ≤ 5.5V	40		ns
	tDIS2	2.5V ≤ VCC < 4.5V	80		ns
	tDIS3	1.8V ≤ VCC < 2.5V	200		ns
Data Hold Time	tDIH1	4.5V ≤ VCC ≤ 5.5V	40		ns
	tDIH2	2.5V ≤ VCC < 4.5V	80		ns
	tDIH3	1.8V ≤ VCC < 2.5V	200		ns
DO pin Output delay	tPD1	4.5V ≤ VCC ≤ 5.5V *3		60	ns
	tPD2	2.5V ≤ VCC < 4.5V *3		150	ns
	tPD3	1.8V ≤ VCC < 2.5V *3		300	ns
RDY/BUSȳ pin Output delay	tPD	CL=100pF		1	μs
Selftimed Programming Time	tE/W			5	ms
Write Recovery Time	tRC		100		ns
Min CS High Time	tCS		250		ns
DO High-Z Time	tOZ			500	ns
Endurance	*4	5.5V, 25°C, Page Write	1,000,000		E/W cycles / Address

\*3 : CL=100pF

\*4 : These parameters are not 100% tested. These are the sample value.

Synchronous Data Timing

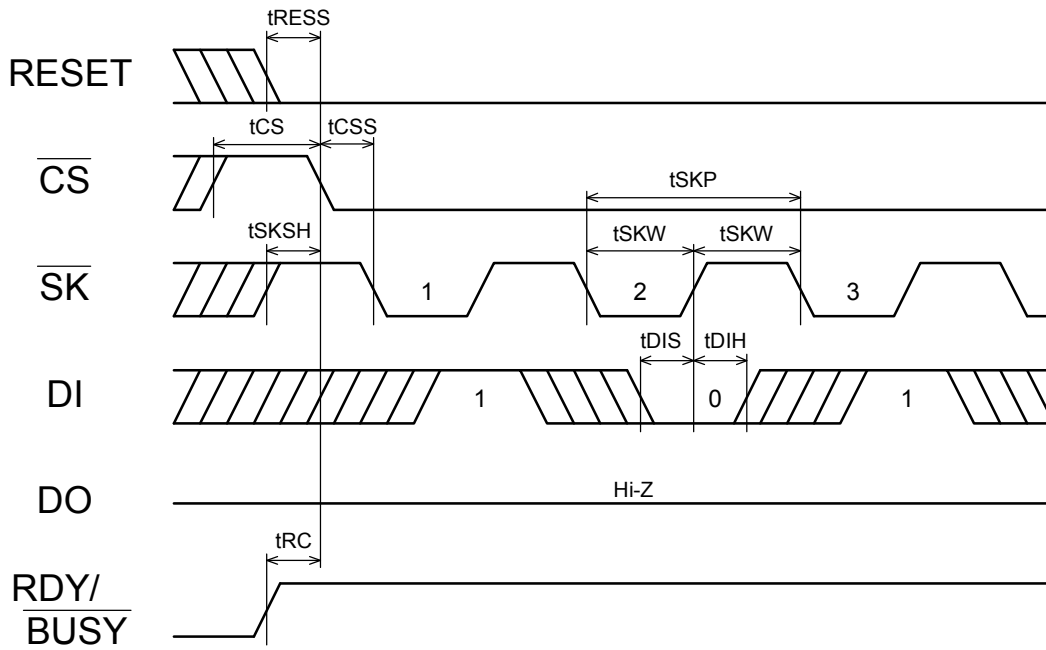

Instruction Input

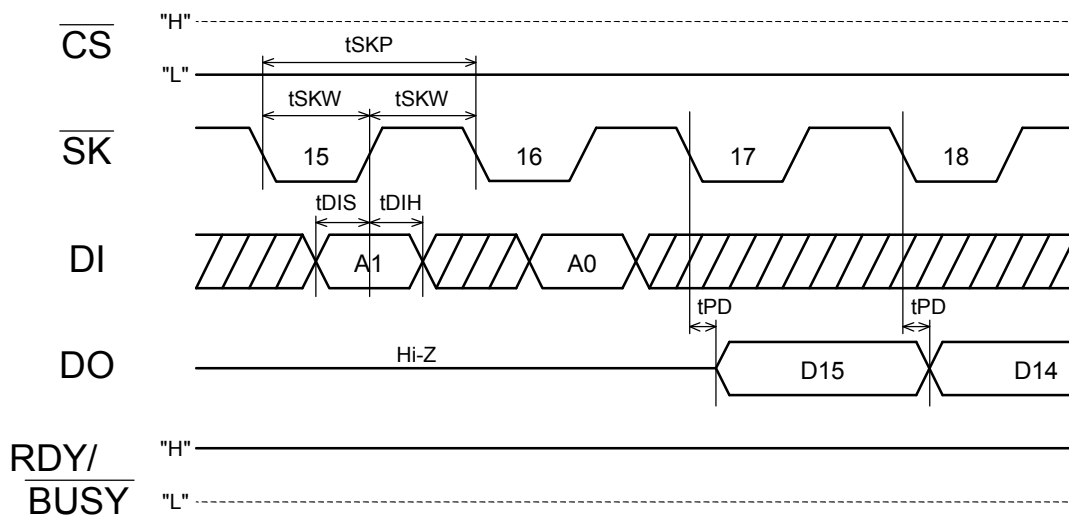

Data Output (READ)

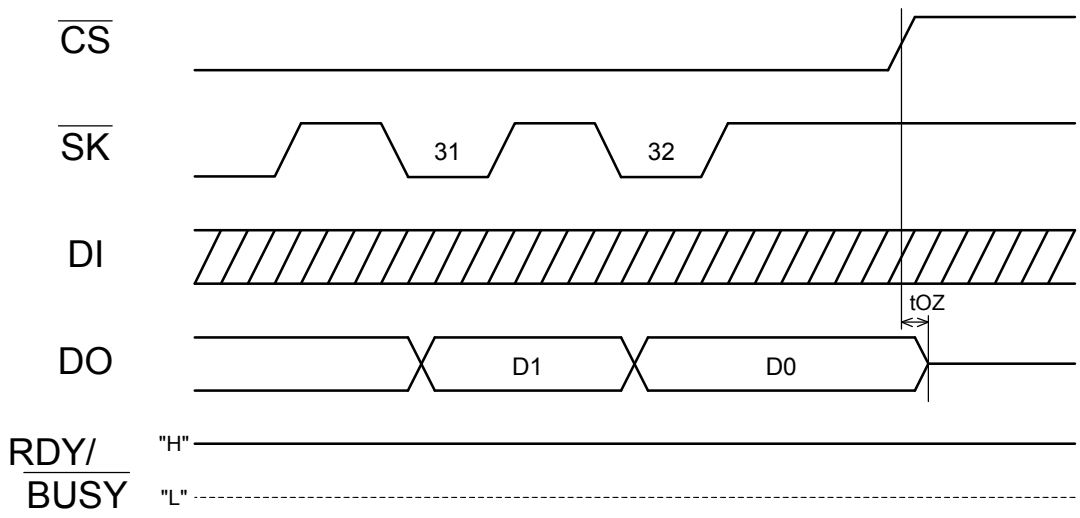

Data Output (READ)

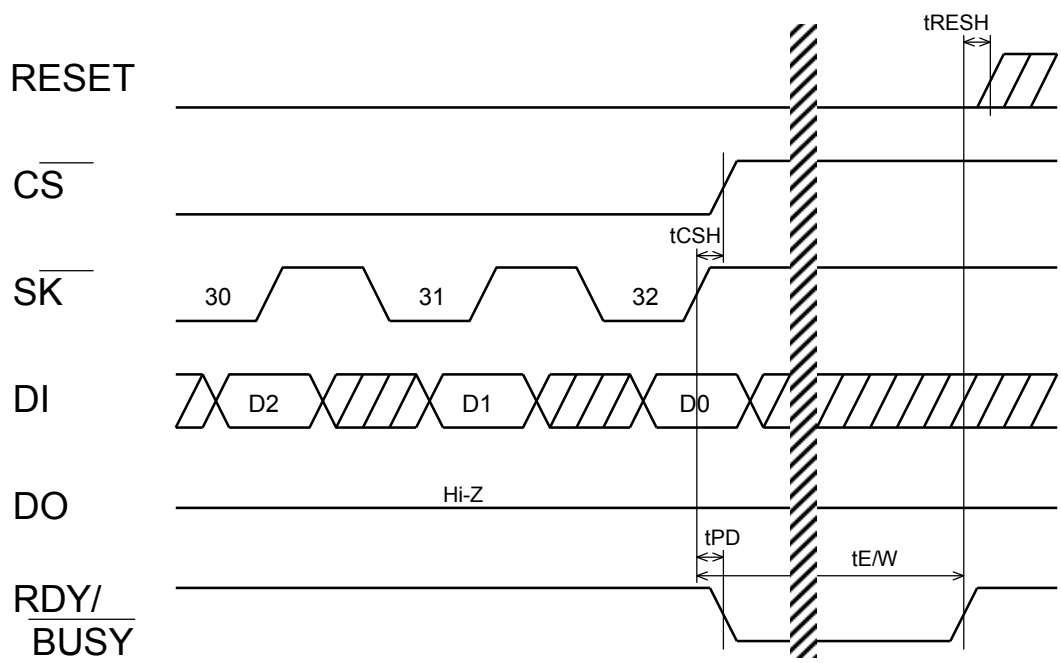

WRITE Ready /  $\overline{Busy}$  Signal Output ( $RDY/\overline{BUSY}$  pin)

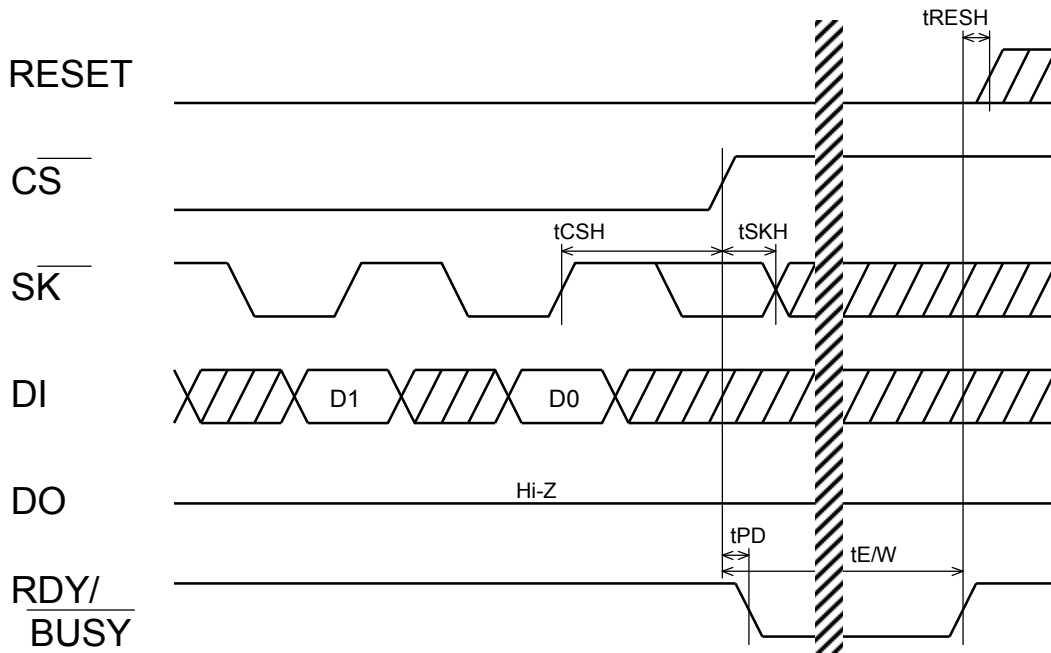

PAGE WRITE Ready / Busy Signal Output (RDY/ BUSY pin)

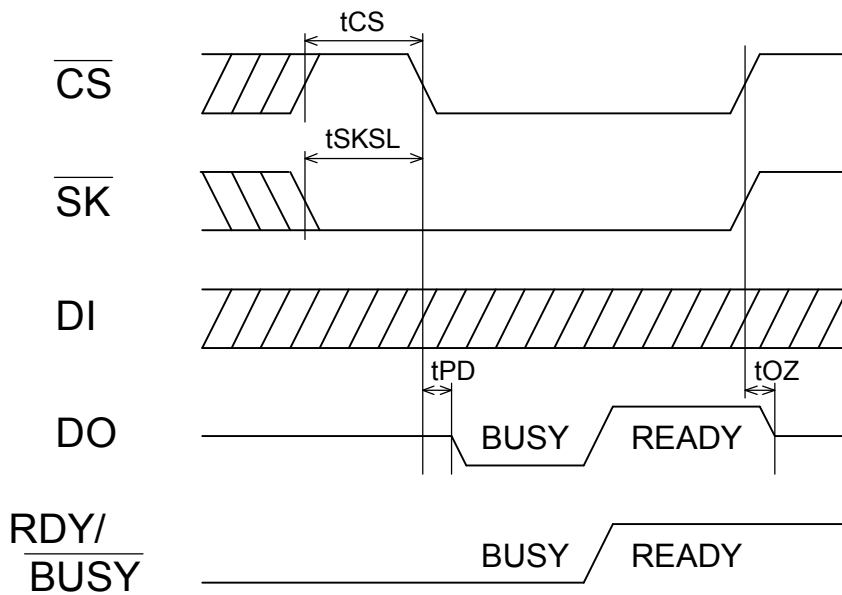

Ready/ Busy Signal Output (DO pin)

#### IMPORTANT NOTICE

- These products and their specifications are subject to change without notice.  
When you consider any use or application of these products, please make inquiries the sales office of Asahi Kasei Microdevices Corporation (AKM) or authorized distributors as to current status of the products.
- Descriptions of external circuits, application circuits, software and other related information contained in this document are provided only to illustrate the operation and application examples of the semiconductor products. You are fully responsible for the incorporation of these external circuits, application circuits, software and other related information in the design of your equipments. AKM assumes no responsibility for any losses incurred by you or third parties arising from the use of these information herein. AKM assumes no liability for infringement of any patent, intellectual property, or other rights in the application or use of such information contained herein.
- Any export of these products, or devices or systems containing them, may require an export license or other official approval under the law and regulations of the country of export pertaining to customs and tariffs, currency exchange, or strategic materials.
- AKM products are neither intended nor authorized for use as critical components<sup>Note1)</sup> in any safety, life support, or other hazard related device or system<sup>Note2)</sup>, and AKM assumes no responsibility for such use, except for the use approved with the express written consent by Representative Director of AKM. As used here:
  - Note1) A critical component is one whose failure to function or perform may reasonably be expected to result, whether directly or indirectly, in the loss of the safety or effectiveness of the device or system containing it, and which must therefore meet very high standards of performance and reliability.
  - Note2) A hazard related device or system is one designed or intended for life support or maintenance of safety or for applications in medicine, aerospace, nuclear energy, or other fields, in which its failure to function or perform may reasonably be expected to result in loss of life or in significant injury or damage to person or property.
- It is the responsibility of the buyer or distributor of AKM products, who distributes, disposes of, or otherwise places the product with a third party, to notify such third party in advance of the above content and conditions, and the buyer or distributor agrees to assume any and all responsibility and liability for and hold AKM harmless from any and all claims arising from the use of said product in the absence of such notification.