

LMF 7.50/02/90 3.5SN OR BX

Weidmüller Interface GmbH & Co. KG
 Klingenbergstraße 26
 D-32758 Detmold
 Germany

www.weidmueller.com

Product image

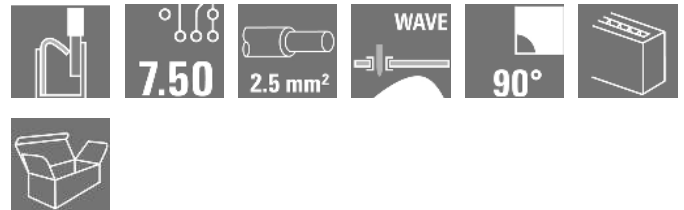

similar to illustration

The innovative quick connector - simple, safe and economical:

PCB terminals with spring connection and direct PUSH IN technology. A milestone in connection technology.

Amazingly simple and simply amazing in practice:

- Connect and easily detach solid wires or wires with wire-end ferrules without using tools
- Processed automatically in the reflow or vapour phase
- Potentials and clamping points marked clearly by coloured push buttons

World-class design-in and processing phases, and suitable for a vast range of applications.

General ordering data

Version	Printed circuit board terminals, 7.50 mm, Number of poles: 2, 90°, Solder pin length (l): 3.5 mm, tinned, orange, PUSH IN with actuator, Clamping range, max. : 2.5 mm ² , Box
Order No.	2667910000
Type	LMF 7.50/02/90 3.5SN OR BX
GTIN (EAN)	4050118804522
Qty.	100 pc(s).
Product data	IEC: 1000 V / 24 A / 0.5 - 2.5 mm ² UL: 300 V / 20 A / AWG 24 - AWG 12
Packaging	Box

Creation date March 30, 2022 7:32:18 PM CEST

LMF 7.50/02/90 3.5SN OR BX

Weidmüller Interface GmbH & Co. KG

Klingenbergstraße 26

D-32758 Detmold

Germany

www.weidmueller.com

Technical data

Dimensions and weights

Depth	19.2 mm	Depth (inches)	0.756 inch
Height	18.3 mm	Height (inches)	0.72 inch
Height of lowest version	14.8 mm	Width	15.2 mm
Width (inches)	0.598 inch	Net weight	3.493 g

System parameters

Product family	OMNIMATE Signal - series LMF	Wire connection method	PUSH IN with actuator
Mounting onto the PCB	THT solder connection	Conductor outlet direction	90°
Pitch in mm (P)	7.5 mm	Pitch in inches (P)	0.295 inch
Number of poles	2	Pin series quantity	1
Solder pin length (l)	3.5 mm	Solder pin dimensions	d = 0.8 mm
Solder eyelet hole diameter (D)	1.1 mm	Solder eyelet hole diameter tolerance (D)+	0,1 mm
Number of solder pins per pole	2	Screwdriver blade	0.6 x 3.5
Screwdriver blade standard	DIN 5264	Stripping length	10 mm
L1 in mm	7.5 mm	Touch-safe protection acc. to DIN VDE 0470	IP 20
Touch-safe protection acc. to DIN VDE 57 106	Safe from finger touch	Protection degree	IP20

Material data

Insulating material	Wemid (PA)	Colour	orange
Colour chart (similar)	RAL 2000	Comparative Tracking Index (CTI)	≥ 600
UL 94 flammability rating	V-0	Contact material	CuSn
Contact surface	tinned	Coating	4-6 µm SN
Tinning type	matt	Layer structure of solder connection	4...8 µm Sn matt
Storage temperature, min.	-40 °C	Storage temperature, max.	70 °C
Operating temperature, min.	-50 °C	Operating temperature, max.	120 °C
Temperature range, installation, min.	-25 °C	Temperature range, installation, max.	120 °C

Conductors suitable for connection

Clamping range, min.	0.12 mm ²	Clamping range, max.	2.5 mm ²
Wire connection cross section AWG, min.	AWG 24	Wire connection cross section AWG, max.	AWG 12
Solid, min. H05(07) V-U	0.5 mm ²	Solid, max. H05(07) V-U	2.5 mm ²
Flexible, min. H05(07) V-K	0.25 mm ²	Flexible, max. H05(07) V-K	2.5 mm ²
w. plastic collar ferrule, DIN 46228 pt 4, min.	0.25 mm ²	w. plastic collar ferrule, DIN 46228 pt 4, max.	2.5 mm ²
w. wire end ferrule, DIN 46228 pt 1, min.	0.25 mm ²	w. wire end ferrule, DIN 46228 pt 1, max.	2.5 mm ²
Reference text	Length of ferrules is to be chosen depending on the product and the rated voltage., The outside diameter of the plastic collar should not be larger than the pitch (P)		

LMF 7.50/02/90 3.5SN OR BX

Weidmüller Interface GmbH & Co. KG

Klingenbergstraße 26

D-32758 Detmold

Germany

www.weidmueller.com

Technical data

Rated data acc. to IEC

tested acc. to standard	IEC 60664-1, IEC 61984	Rated current, min. number of poles (Tu=20°C)	24 A
Rated current, max. number of poles (Tu=20°C)	24 A	Rated current, min. number of poles (Tu=40°C)	24 A
Rated current, max. number of poles (Tu=40°C)	24 A	Rated voltage for surge voltage class / pollution degree II/2	1,000 V
Rated voltage for surge voltage class / pollution degree III/2	600 V	Rated voltage for surge voltage class / pollution degree III/3	500 V
Rated impulse voltage for surge voltage class/ pollution degree II/2	6 kV	Rated impulse voltage for surge voltage class/ pollution degree III/2	6 kV
Rated impulse voltage for surge voltage class/ contamination degree III/3	6 kV	Short-time withstand current resistance	3 x 1s with 120 A

Rated data acc. to CSA

Institute (CSA)		Certificate No. (CSA)	200039-1815154
Rated voltage (Use group B / CSA)	300 V	Rated voltage (Use group D / CSA)	300 V
Rated current (Use group B / CSA)	20 A	Rated current (Use group D / CSA)	10 A
Wire cross-section, AWG, min.	AWG 24	Wire cross-section, AWG, max.	AWG 12
Reference to approval values	Specifications are maximum values, details - see approval certificate.		

Rated data acc. to UL 1059

Institute (cURus)		Certificate No. (cURus)	E60693
Rated voltage (Use group B / UL 1059)	300 V	Rated voltage (Use group D / UL 1059)	300 V
Rated current (Use group B / UL 1059)	20 A	Rated current (Use group D / UL 1059)	10 A
Wire cross-section, AWG, min.	AWG 24	Wire cross-section, AWG, max.	AWG 12
Reference to approval values	Specifications are maximum values, details - see approval certificate.		

Packing

Packaging	Box	VPE length	350 mm
VPE width	139 mm	VPE height	31 mm

Classifications

ETIM 6.0	EC002643	ETIM 7.0	EC002643
ETIM 8.0	EC002643	ECLASS 9.0	27-44-04-01
ECLASS 9.1	27-44-04-01	ECLASS 10.0	27-44-04-01
ECLASS 11.0	27-46-01-01		

LMF 7.50/02/90 3.5SN OR BX

Weidmüller Interface GmbH & Co. KG
Klingenbergstraße 26
D-32758 Detmold
Germany

www.weidmueller.com

Technical data

Important note

IPC conformity	Conformity: The products are developed, manufactured and delivered according international recognized standards and norms and comply with the assured properties in the data sheet resp. fulfill decorative properties in accordance with IPC-A-610 "Class 2". Further claims on the products can be evaluated on request.
Notes	<ul style="list-style-type: none">• Additional variants on request• Rated current related to rated cross-section & min. No. of poles.• Wire end ferrule without plastic collar to DIN 46228/1• Wire end ferrule with plastic collar to DIN 46228/4• P on drawing = pitch• Rated data refer only to the component itself. Clearance and creepage distances to other components are to be designed in accordance with the relevant application standards.• The test point can only be used as potential-pickup point.• Long term storage of the product with average temperature of 50 °C and average humidity 70%, 36 months

Approvals

Approvals



UL File Number Search

E60693

Downloads

Catalogues

[Catalogues in PDF-format](#)

LMF 7.50/02/90 3.5SN OR BX

Weidmüller Interface GmbH & Co. KG
 Klingenbergstraße 26
 D-32758 Detmold
 Germany

www.weidmueller.com

Drawings

Dimensional drawing

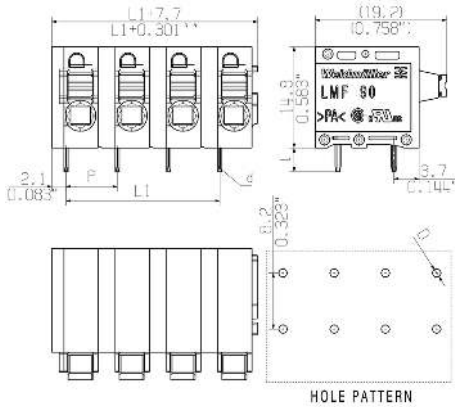

Derating curve

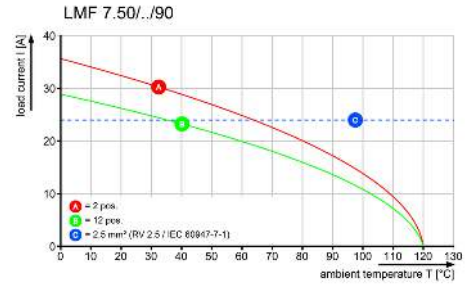

Derating curve

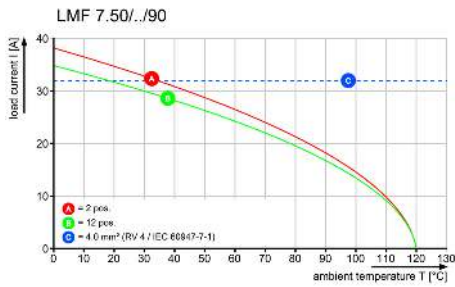

Product benefits

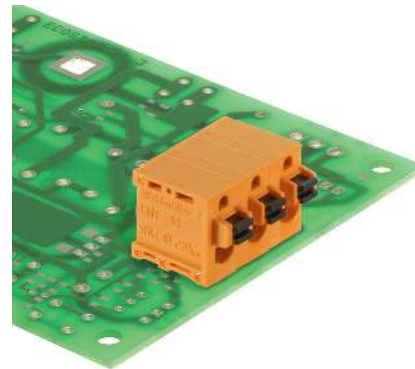

Product benefits

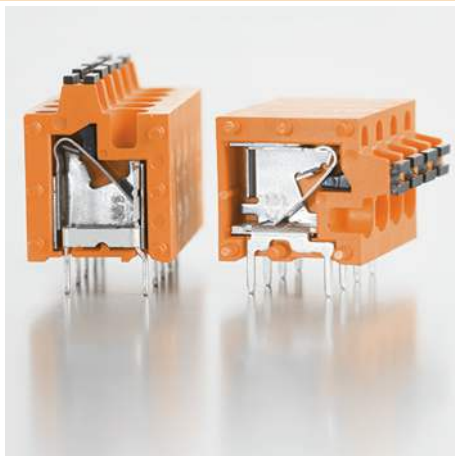

Product benefits

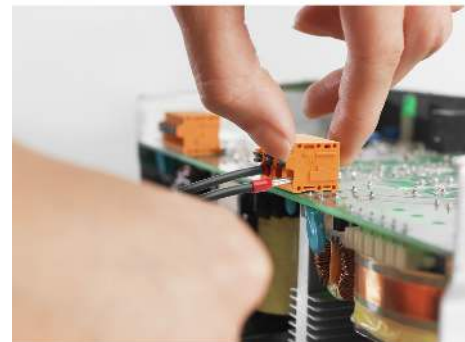

Data sheet

LMF 7.50/02/90 3.5SN OR BX

Weidmüller Interface GmbH & Co. KG
Klingenbergstraße 26
D-32758 Detmold
Germany

www.weidmueller.com

Drawings

Product benefits



Recommended wave soldering profiles

Weidmüller Interface GmbH & Co. KG
 Klängenbergstraße 16
 D-32758 Detmold
 Germany
 Fon: +49 5231 14-0
 Fax: +49 5231 14-292083
 www.weidmueller.com

Single Wave:



Double Wave:



Wave soldering profiles

Wired connection elements should be processed in accordance with the DIN EN 61760-1 standard. We have included two recommendations for practical wave soldering profiles, with which Weidmüller PCB terminals and connectors are qualified.

When choosing a suitable profile for your application, the following factors also need to be considered:

- PCB thickness
- Proportion of Cu in the layers
- Single/double-sided assembly
- Product range
- Heating and cooling rates

The single and double wave profiles each indicate the recommended operating range, including the maximum soldering temperature of 260°C. In practice, the maximum soldering temperature is quite often well below the above maximum profile.