

Product Data Sheet

653 Series

Features

- Gauge, vacuum and compound ranges through 0 psig to 10,000 psig
- For static and dynamic load measurements
- No internal sealing elements
- Stainless steel wetted parts
- Piezoresistive silicon chip
- Compact size
- CE compliant

Applications

- Hydraulics & pneumatics
- Automotive
- Pumps & compressors
- Refrigeration controls
- Transportation



Specifications

| | |
|-------------------------------|---|
| Output signals | 4 mA to 20 mA 2-wire, 0 Vdc to 5 Vdc 3-wire, 1 Vdc to 5 Vdc 3-wire, 0 Vdc to 10 Vdc 3 wire, 0.5 Vdc to 4.5 Vdc 3-wire (ratiometric) |
| Pressure ranges | Gauge, vacuum and compound ranges through 0 psig to 10,000 psig; other ranges available, consult factory |
| Accuracy | ±0.5% full scale (BFSL) (IEC 61298-2) |
| Response time | ≤1 ms |
| Service life | ≥1,000,000 load cycles |
| Temperature ranges | Media -22 °F to 221 °F (-30 °C to 105 °C) Ambient -4 °F to 185 °F (-20 °C to 85 °C) Storage -40 °F to 257 °F (-40 °C to 125 °C) |
| Power requirement* | 12 Vdc to 36 Vdc (4 mA to 20 mA, 2-wire) 12 Vdc to 36 Vdc (0 Vdc to 5 Vdc, 1 Vdc to 5 Vdc, 3-wire) 12 Vdc to 36 Vdc (0 Vdc to 10 Vdc, 3-wire) 5 Vdc ± 10% (0.5 Vdc to 4.5 Vdc ratiometric, 3-wire) |
| Proof pressure | ≥2,000 psi: 1.2 times full scale; <2,000 psi: 2 times full scale |
| Measuring element | 316 Stainless Steel |
| Connection | 304 Stainless Steel |
| Housing material | 304 Stainless Steel |
| Environmental rating | IP65 for Mini-Hirschmann (DIN EN 175301-803 form C) without mating connector and Hirschmann (DIN EN 175301-803 form A) without mating connector; IP67 for M12 x 1 (4-pin) connection |
| Electromagnetic rating | Immunity: IEC 61000-6-2 Radiation: IEC 61000-6-3 |
| Electrical protection | Reverse polarity and short circuit protection |
| Shock resistance | Shock: 200g/1ms; IEC 60068-2-27 Free fall: 1m; IEC 60068-2-32 |
| Vibration resistance | Sine curve, 20g, 25Hz~2kHz; IEC 60068-2-6 Random: 7.5grms, 5Hz~1kHz, IEC 60068-2-64 |
| Weight | Approximately 3.4 oz. |

* Unregulated

Product Data Sheet

653 Series

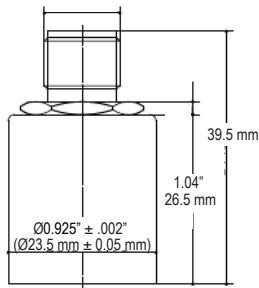
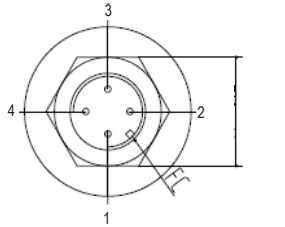

M12 X 1 (4-pin)

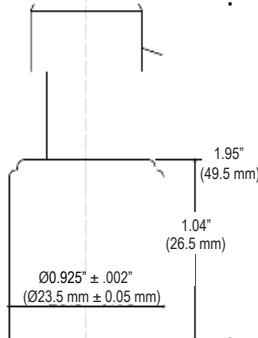
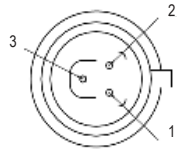

Metri-Pack 150 Series

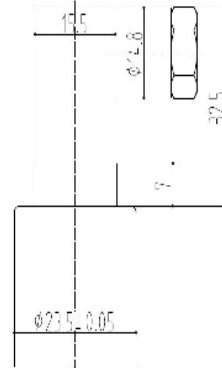
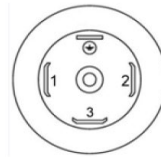

Mini-Hirschman (4-pin)

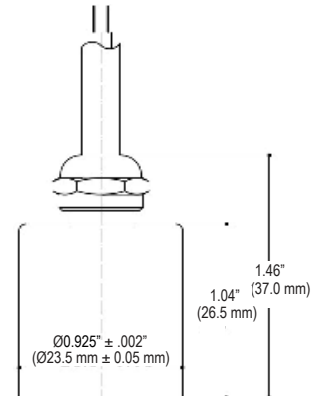

18" Integral cable

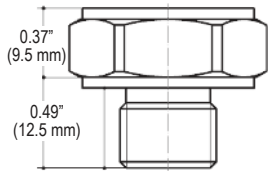

G1/4A Male

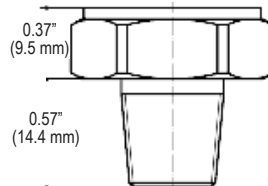

1/4" NPT Male

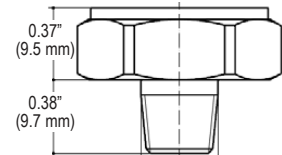

1/8" NPT Male

2-WIRE WIRING

| Wiring | Cable | M12 | Metri-Pack | Mini-Hirschmann |
|----------|-------|-----|------------|-----------------|
| + Supply | Red | 1 | 1 | 1 |
| + Output | Green | 2 | 2 | 2 |

3-WIRE WIRING

| Wiring | Cable | M12 | Metri-Pack | Mini-Hirschmann |
|----------|--------|-----|------------|-----------------|
| + Supply | Red | 1 | 1 | 1 |
| Common | Green | 3 | 2 | 2 |
| + Output | Yellow | 4 | 3 | 3 |