

Using the UCC28711EVM-160

User's Guide



Literature Number: SLUUA12
November 2012



WARNING

Always follow TI's set-up and application instructions, including use of all interface components within their recommended electrical rated voltage and power limits. Always use electrical safety precautions to help ensure your personal safety and the safety of those working around you. Contact TI's Product Information Center <http://support/ti.com> for further information.

Save all warnings and instructions for future reference.

Failure to follow warnings and instructions may result in personal injury, property damage, or death due to electrical shock and/or burn hazards.

The term TI HV EVM refers to an electronic device typically provided as an open framed, unenclosed printed circuit board assembly. It is intended strictly for use in development laboratory environments, solely for qualified professional users having training, expertise, and knowledge of electrical safety risks in development and application of high-voltage electrical circuits. Any other use and/or application are strictly prohibited by Texas Instruments. If you are not suitably qualified, you should immediately stop from further use of the HV EVM.

1. Work Area Safety:

- (a) Keep work area clean and orderly.
- (b) Qualified observer(s) must be present anytime circuits are energized.
- (c) Effective barriers and signage must be present in the area where the TI HV EVM and its interface electronics are energized, indicating operation of accessible high voltages may be present, for the purpose of protecting inadvertent access.
- (d) All interface circuits, power supplies, evaluation modules, instruments, meters, scopes and other related apparatus used in a development environment exceeding 50 V_{RMS}/75 VDC must be electrically located within a protected Emergency Power Off (EPO) protected power strip.
- (e) Use a stable and non-conductive work surface.
- (f) Use adequately insulated clamps and wires to attach measurement probes and instruments. No freehand testing whenever possible.

2. Electrical Safety:

- (a) De-energize the TI HV EVM and all its inputs, outputs, and electrical loads before performing any electrical or other diagnostic measurements. Revalidate that TI HV EVM power has been safely de-energized.
- (b) With the EVM confirmed de-energized, proceed with required electrical circuit configurations, wiring, measurement equipment hook-ups and other application needs, while still assuming the EVM circuit and measuring instruments are electrically live.
- (c) Once EVM readiness is complete, energize the EVM as intended.

WARNING: while the EVM is energized, never touch the EVM or its electrical circuits as they could be at high voltages capable of causing electrical shock hazard.

3. Personal Safety:

- (a) Wear personal protective equipment e.g. latex gloves and/or safety glasses with side shields or protect EVM in an adequate lucent plastic box with interlocks from accidental touch.

4. Limitation for Safe Use:

- (a) EVMs are not to be used as all or part of a production unit.

Using the UCC28711EVM-160 5-W USB Adapter

1 Description

The UCC28711EVM-160 is a 5-W evaluation module for evaluating an off-line adapter for USB applications. It is intended for evaluation purposes and is not intended to be an end product. The UCC28711EVM-160 converts 100-V to 240-V RMS input voltage down to 5-V DC, with a 1-A current limit for USB adapter applications.

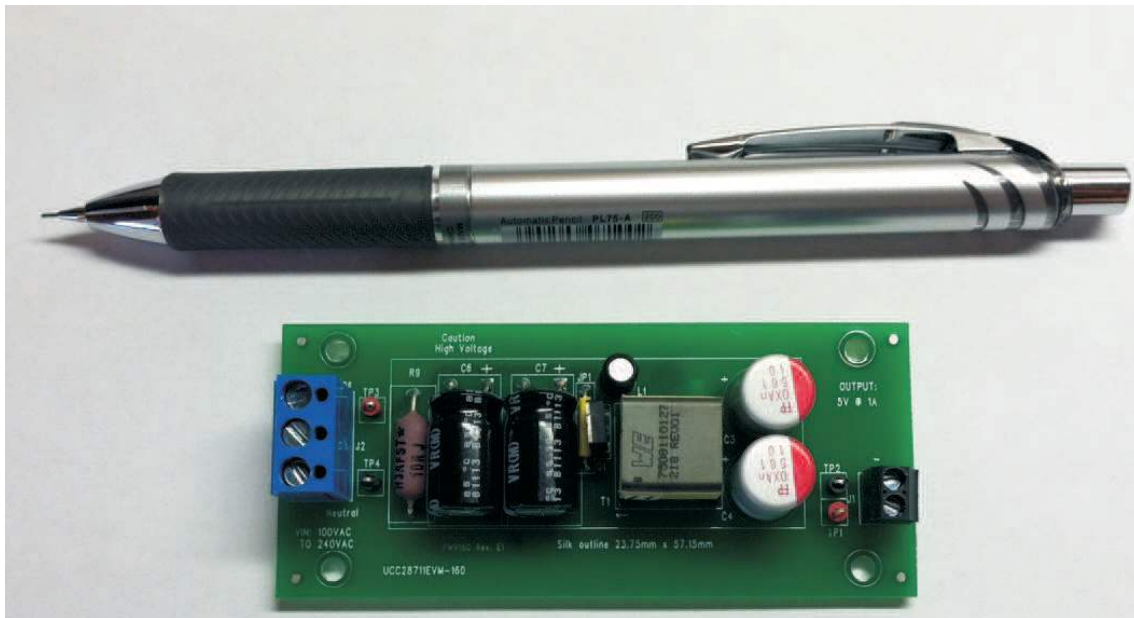

Figure 1. UCC28711EVM-160

2 Electrical Performance Specifications

Table 1. UCC28711EVM-160 Electrical Performance Specifications

SYMBOL	PARAMETER	TEST CONDITION	MIN	TYP	MAX	UNITS
Input Characteristics						
V_{IN}	Input voltage		100	115/230	240	V
	No load input power (115-V and 230-V RMS input)	$V_{IN} = \text{nom}$, $I_{OUT} = 0 \text{ A}$			10	mW
Output Characteristics						
V_{OUT}	Output voltage	$V_{IN} = \text{nom}$, $I_{OUT} = \text{nom}$	4.75	5	5.25	V
	Line regulation	$V_{IN} = \text{min to max}$, $I_{OUT} = \text{nom}$			3%	
	Load regulation	$V_{IN} = \text{nom}$, $I_{OUT} = \text{min to max}$			3%	
V_{OUT_ripple}	Output voltage ripple	$V_{IN} = \text{nom}$, $I_{OUT} = \text{max}$			0.1	mVpp
I_{OUT}	Output current	$V_{IN} = \text{min to max}$		1	1.1	A
V_{OVP}	Output OVP	$I_{OUT} = \text{min to max}$		5.75		V
Transient Response						
V_{OUT}	Load Step ($V_{OUT} = 4.1 \text{ V to } 6 \text{ V}$)	0.1 A to 0.6 A	4.1		6	V
Systems Characteristics						
	Full load efficiency (115-V and 230-V RMS input)	$R_{load} = 5 \Omega$	74.0%		76%	
Top	Operating temperature range	$V_{IN} = \text{min to max}$, $I_{OUT} = \text{min to max}$	25		40	°C

4 Test Setup

Safety: This evaluation module is not encapsulated and there are voltages that are much greater than 50 V DC.

NOTE: If you are not trained in the proper safety of handling and testing power electronics please do not test this evaluation module.

Voltage Source: Isolated AC source or variable AC transformer capable of 265-V AC cable of handling 10 W.

Voltmeter: Two digital voltage meter.

Power Analyzer: Capable of measuring 1 mW to 10 W of input power capable of handling 265-V RMS input voltage. Most power analyzers require a precision shunt resistor for measuring input current to measure input power of 5 W or less. Please read power analyzer's User manual for proper setup.

Oscilloscope:

- Four channel 100 MHz.
- Probes capable of handling 600 V.

Output Load: Resistive or electronic load capable handling 5 W at 5 V.

Recommended Wire Gauge: Insulated 22 AWG.

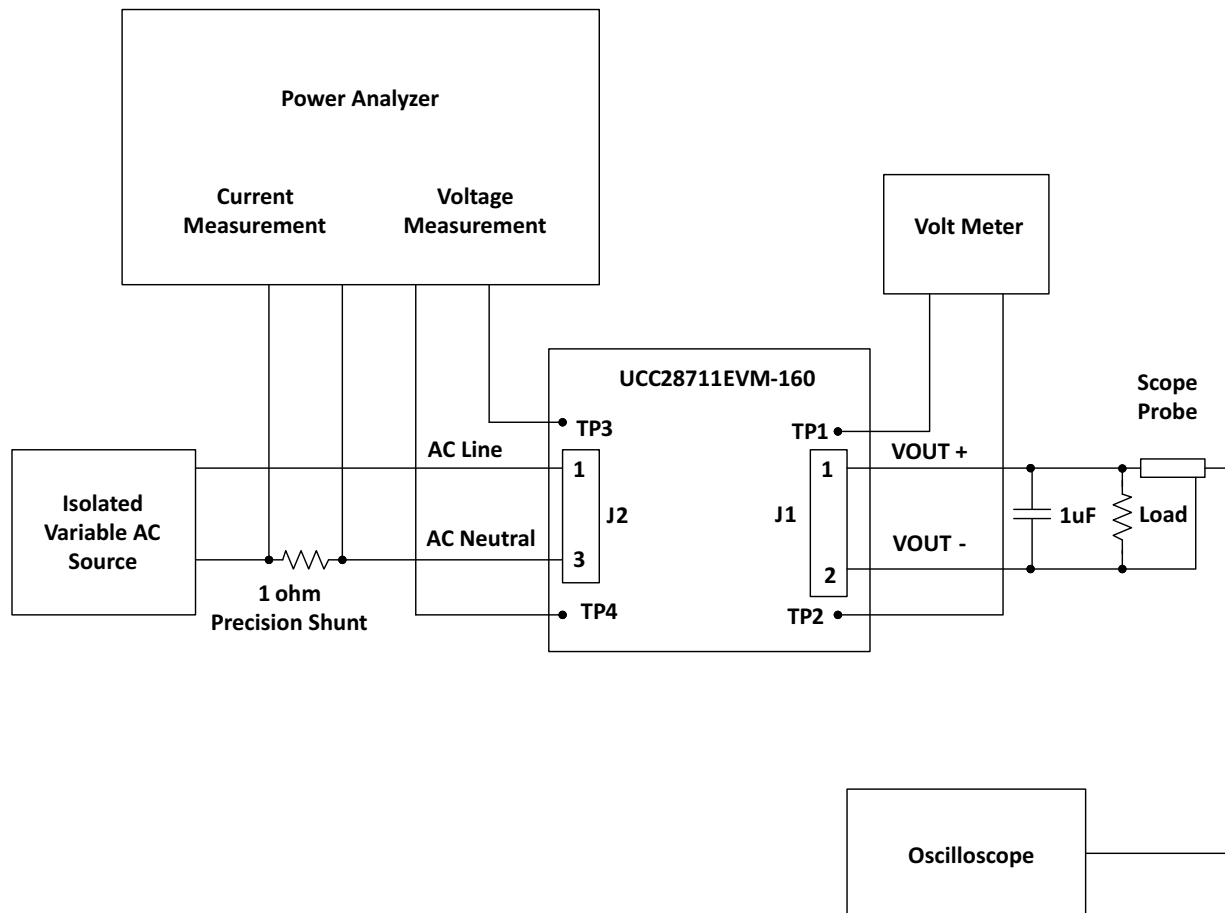

Figure 3. Test Setup

5 List of Test Points

Table 2. Test Point Function

TEST POINTS	NAME	DESCRIPTION
TP3	AC line	Kelvin connection for AC line
TP4	AC neutral	Kelvin connection for AC neutral
TP1	VOOUT +	Kelvin connection for VOOUT +
TP2	VOOUT -	Kelvin connection for VOOUT -

6 Performance Data and Typical Characteristic Curves

6.1 Efficiency

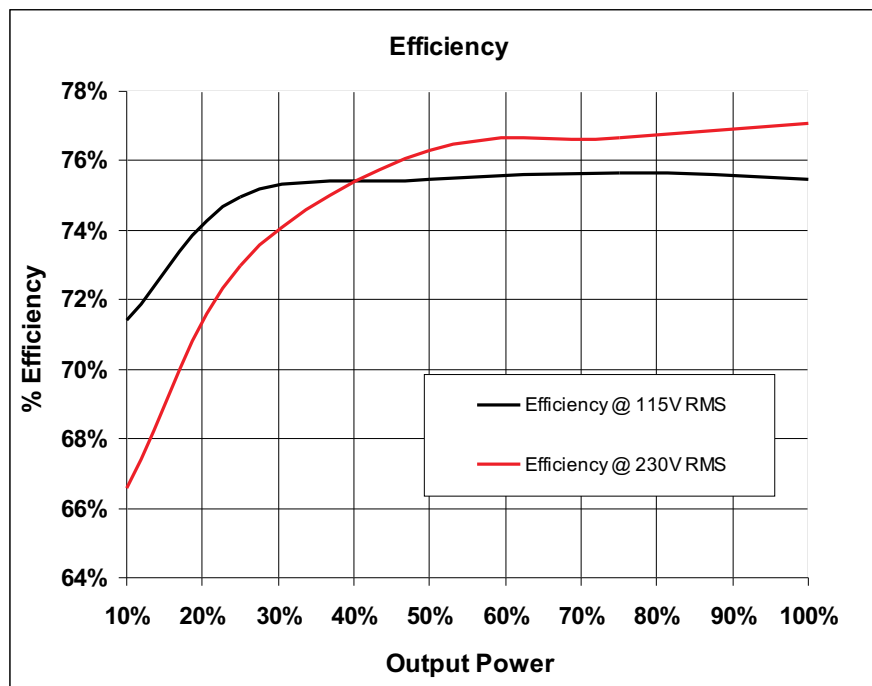

Figure 4. UCC28711EVM-160 Efficiency

6.2 Startup at 115 V

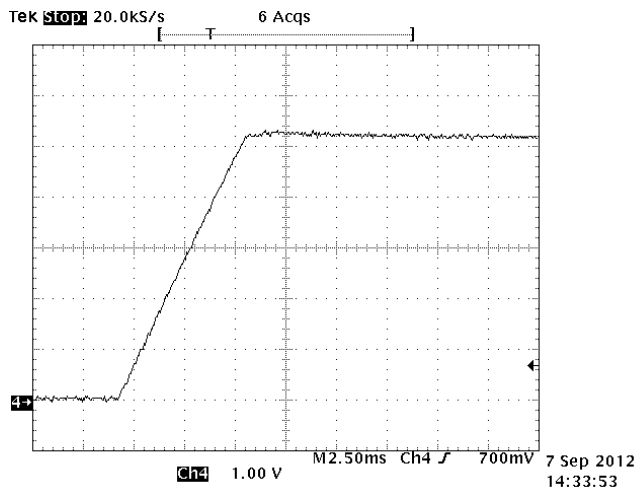

Figure 5. No Load

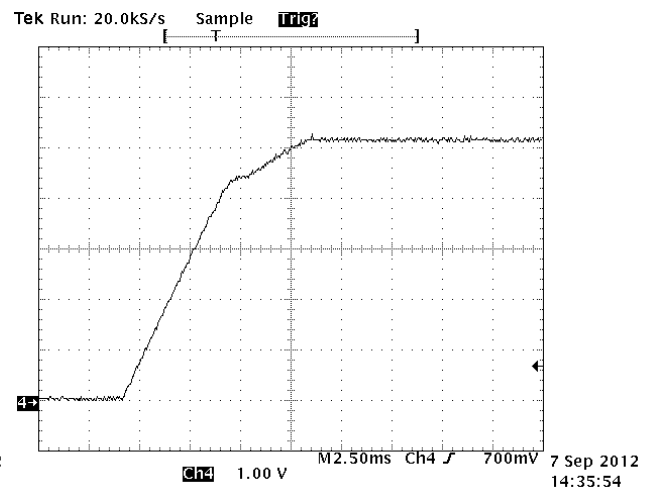

Figure 6. 5-Ω Load

6.3 Startup at 230 V

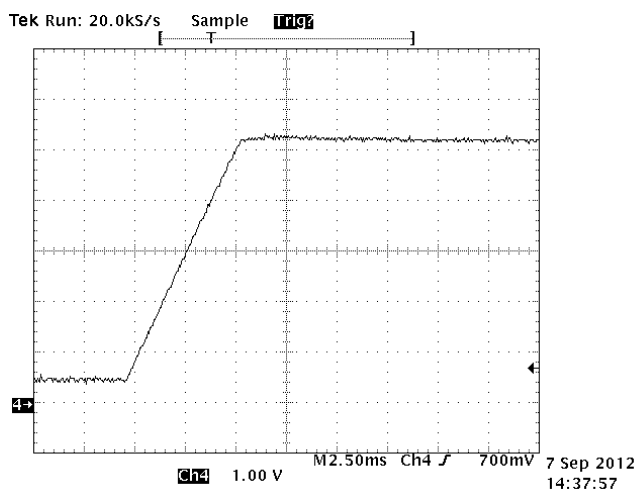

Figure 7. No Load

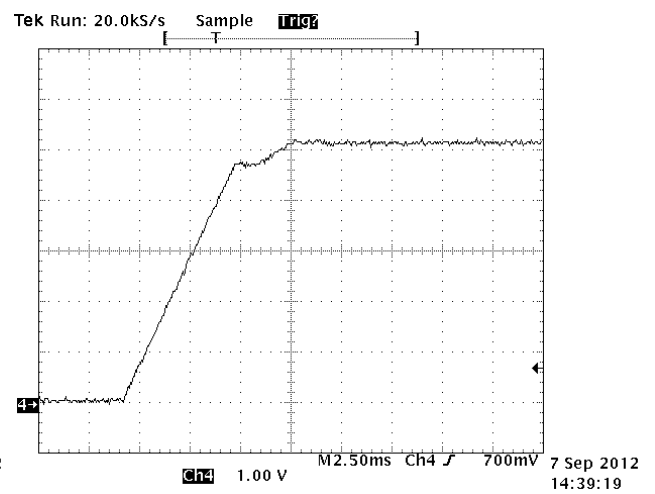

Figure 8. 5-Ω Load

6.4 6.5 Load Transient at 115 V RMS

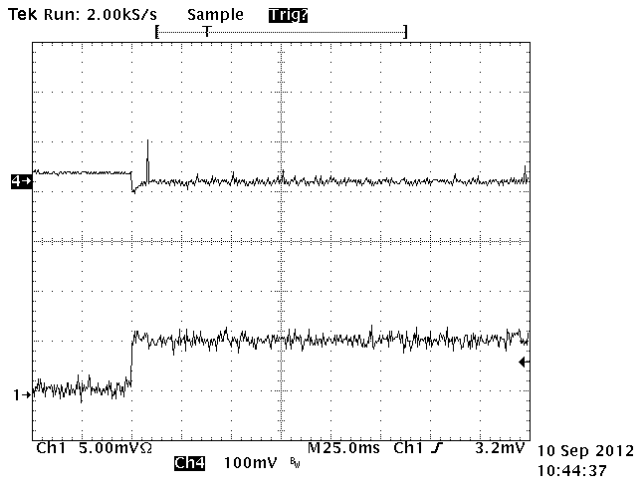

Figure 9. 0.1-A to 0.6-A Load Step

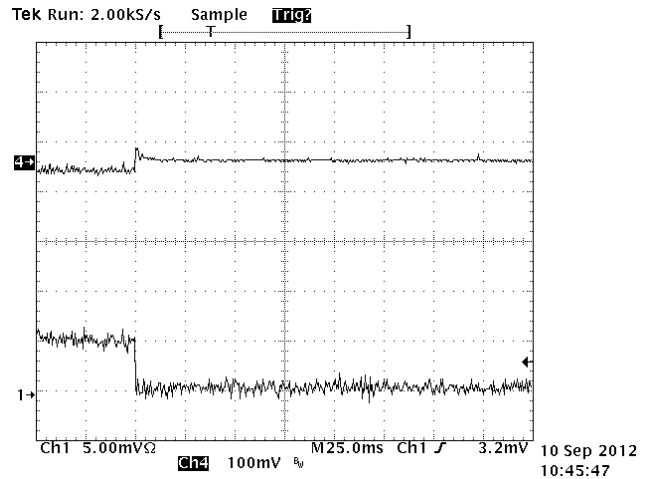

Figure 10. 0.6-A to 0.1-A Load Step

6.5 Load Transient at 230 V RMS

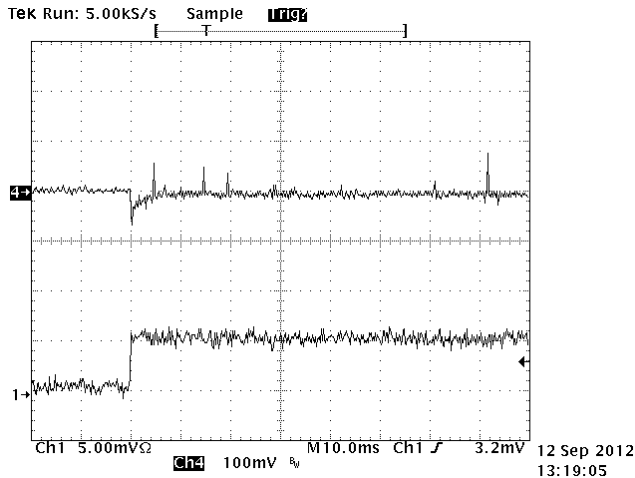

Figure 11. 0.1-A to 0.6-A Load Step

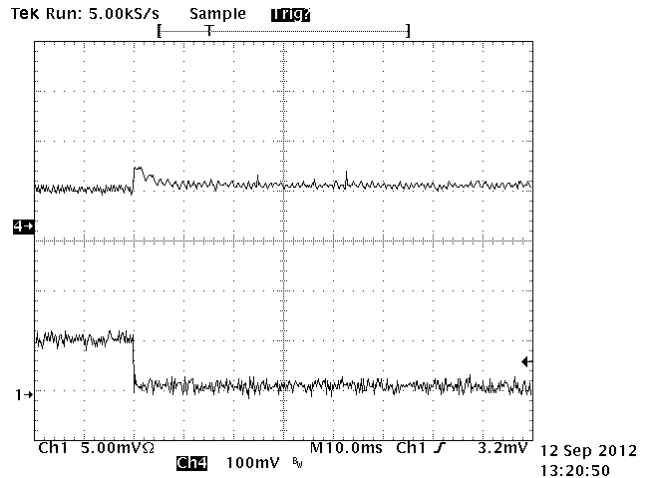

Figure 12. 0.6-A to 0.1-A Load Step

6.6 Output Ripple Voltage at Full Load

- CH4 = V_{OUT} at EVM output.
- CH2 = V_{OUT} measure at the end of the 3 M of cable in parallel with a 1- μ F capacitor. The output voltage has less than 50 mV of output ripple at the end of the cable.

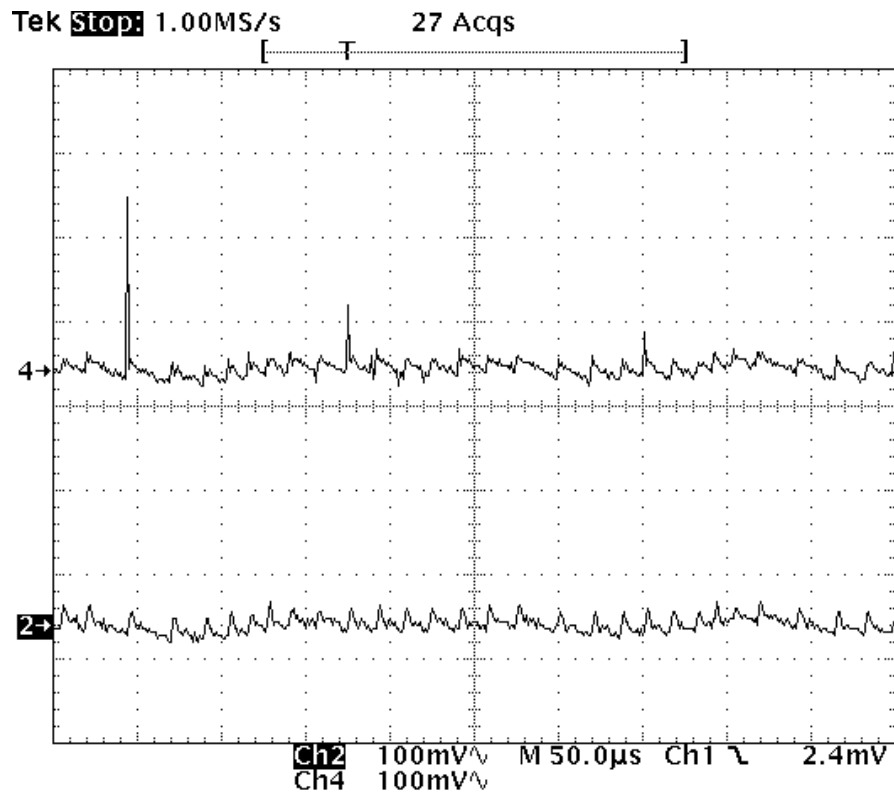

Figure 13. Output Ripple Voltage at Full Load

7 EVM Assembly Drawing and PCB Layout

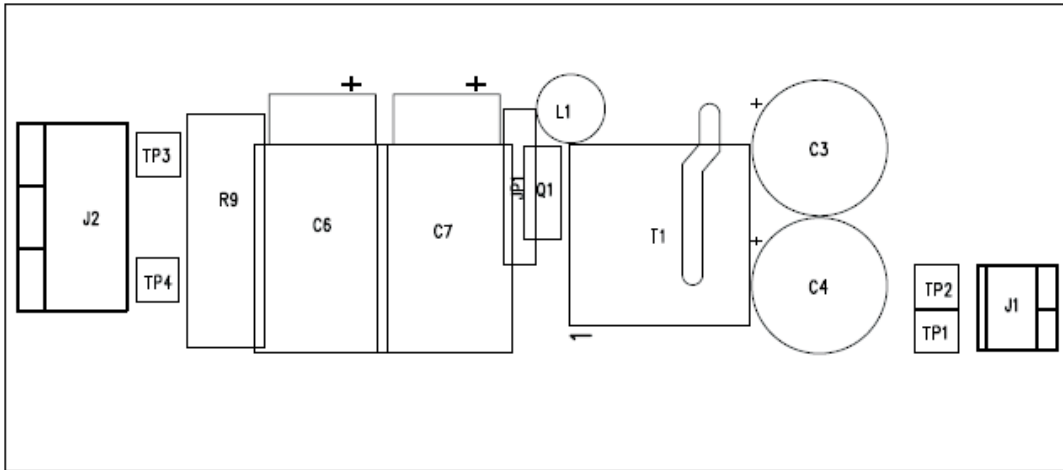

Figure 14. Top Assembly Drawing

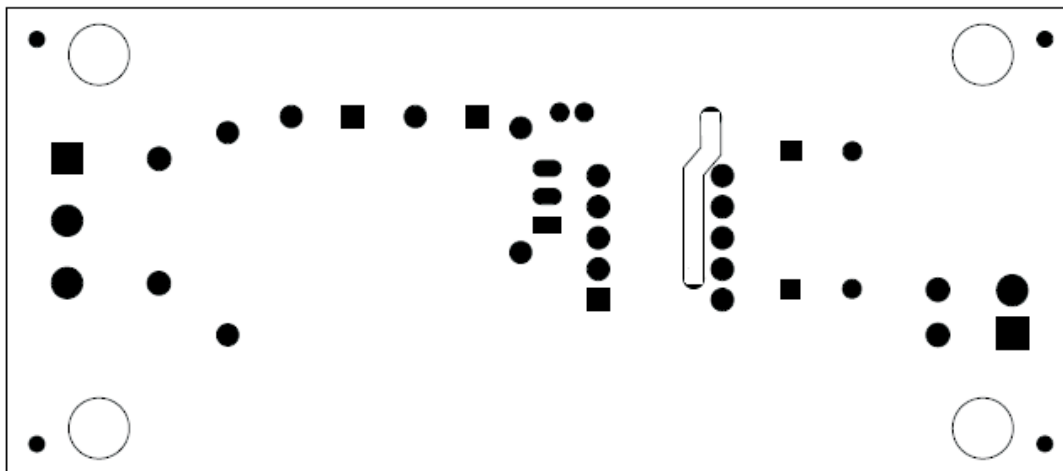

Figure 15. Top PCB Drawing

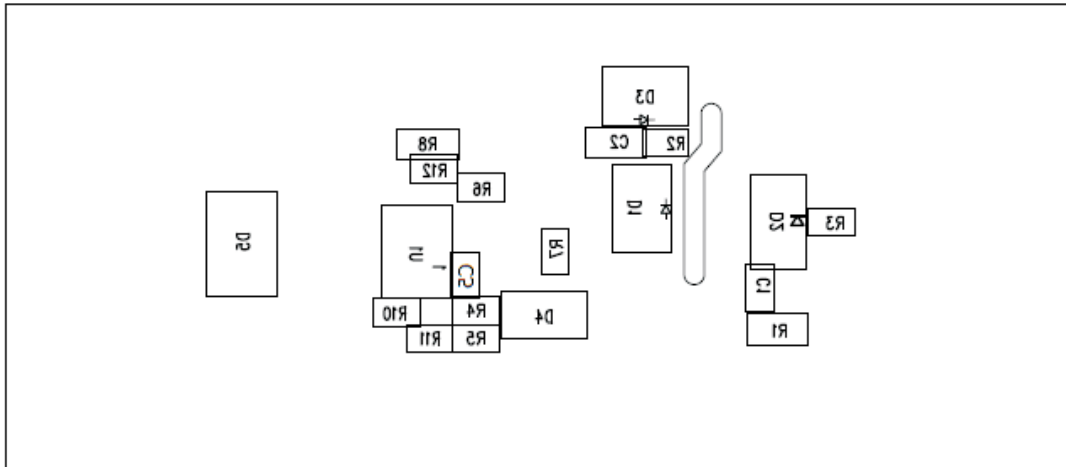

Figure 16. Bottom Assembly Drawing

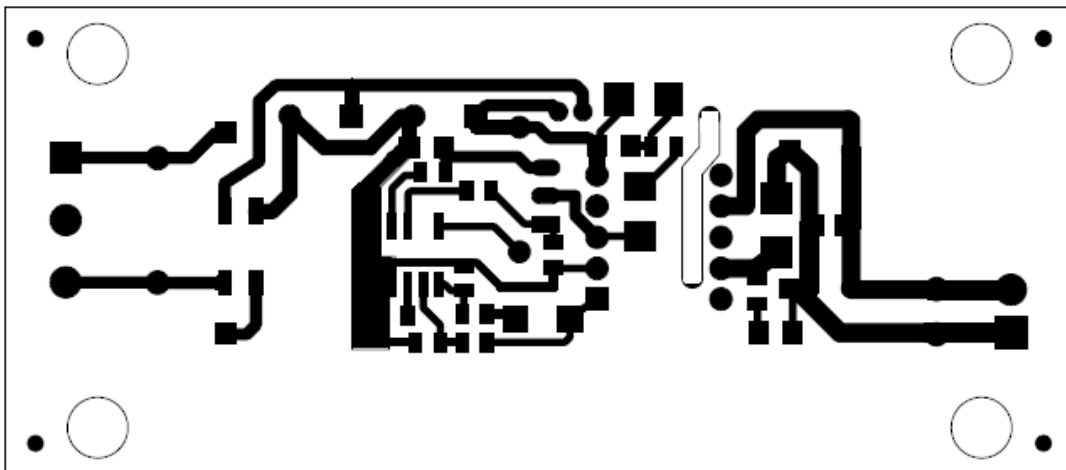

Figure 17. CB Assembly Drawing

8 List of Materials

The EVM components list according to the schematic shown in [Figure 2](#).

Table 3. UCC28711EVM-160 List of Materials

COUNT	RefDes	Description	Part Number	MFR
1	C1	Capacitor, ceramic, 50 V, X7R, $\pm 10\%$, 0805, 1 nF	STD	STD
1	C5	Capacitor, ceramic, 50 V, X7R, $\pm 10\%$, 0805, 330 nF	STD	STD
1	C2	Capacitor, ceramic chip, 200 V, X7R, $\pm 10\%$, 1206, 1 nF	STD	STD
2	C3, C4	Capacitor, electrolytic, 16 VDC, -55 to 125°C, $\pm 20\%$, 560 μ F	EEU-FC1C561	Panasonic
2	C6, C7	Capacitor, electrolytic, 400 V, -25 to 85°C, $\pm 20\%$, 4.7 μ F	UVR2G4R7MPD	Nichicon
1	D1	Diode, ultrafast rectifier, 1 A, 600 V, SMB	MURS160-13-F	Diodes Inc
1	D2	Diode, Schottky, 3 A, 40 V, SMB	B340LB	Diodes Inc
1	D3	Diode, transient voltage suppressor, 600 W, 82 V, SMB	SMBJP6KE82A-TP	Micro Commercial Co
1	D4	Diode, 1 A, 100 V, SMA	RS1B-13-F	Diodes Inc
1	D5	Bridge rectifier, 600 V, 0.8 A, glass passivated, SMD	HD04	Diodes, Inc
1	J1	Terminal block, 2 pin, 6 A, 3.5 mm	ED555/2DS	OST
1	J2	Terminal block, 3 pin, 15 A, 5.1 mm	ED120/3DS	OST
1	JP1	Jumper, 0.400 inch, PVC insulation, AWG 22,	923345-04-C	3M
1	L1	Inductor, radial, $\pm 10\%$, 470 μ H	RLB0608-471KL	Bourns
1	Q1	MOSFET, N-channel, 700 V, 1.6 A, 7 Ω , IPAK	STD2NK70Z-1	Vishay
1	R1	Resistor, chip 1/4 W, $\pm 1\%$, 1206, 39 Ω	STD	STD
1	R10	Thermistor NTC, 100 k Ω , SMD, 0805	NTCS0805E3104FXT	Vishay BC Components
1	R11	Resistor, chip, 1/10 W, 1%, 0805, 27.4 k Ω	STD	STD
1	R12	Resistor, chip, 1/10 W, 1%, 0805, 1.00 k Ω	STD	STD
1	R2	Resistor, chip, 1/10 W, 1%, 0805, 649 Ω	STD	STD
1	R3	Resistor, chip, 1/10 W, 1%, 0805, 15.4 k Ω	STD	STD
1	R4	Resistor, chip, 1/10 W, 1%, 0805, 22.5 Ω	STD	STD
1	R5	Resistor, chip, 1/10 W, 1%, 0805, 82.5 k Ω	STD	STD
1	R6	Resistor, chip, 1/10 W, 1%, 0805, 10 Ω	STD	STD
1	R7	Resistor, chip, 1/10 W, 1%, 0805, 10.0 k Ω	STD	STD
1	R8	Resistor, chip 1/4 W, $\pm 1\%$, 1206, 1.96 Ω	STD	STD
1	R9	10 ohm, TH fusible power resistor, 3 W, 10 Ω	PWR4522AS10R0JA	Bourns
1	T1	Transformer, $\pm 10\%$, 1.05 mH, 4.24:1	7508110127REV01	
4	TP1, TP2, TP3, TP4	Test point, red, thru-hole color keyed	5000	Keystone
1	U1	Constant-Voltage, Constant-Current PWM With Primary-Side Regulation, SO-8	UCC28711D	TI

EVALUATION BOARD/KIT/MODULE (EVM) ADDITIONAL TERMS

Texas Instruments (TI) provides the enclosed Evaluation Board/Kit/Module (EVM) under the following conditions:

The user assumes all responsibility and liability for proper and safe handling of the goods. Further, the user indemnifies TI from all claims arising from the handling or use of the goods.

Should this evaluation board/kit not meet the specifications indicated in the User's Guide, the board/kit may be returned within 30 days from the date of delivery for a full refund. THE FOREGOING LIMITED WARRANTY IS THE EXCLUSIVE WARRANTY MADE BY SELLER TO BUYER AND IS IN LIEU OF ALL OTHER WARRANTIES, EXPRESSED, IMPLIED, OR STATUTORY, INCLUDING ANY WARRANTY OF MERCHANTABILITY OR FITNESS FOR ANY PARTICULAR PURPOSE. EXCEPT TO THE EXTENT OF THE INDEMNITY SET FORTH ABOVE, NEITHER PARTY SHALL BE LIABLE TO THE OTHER FOR ANY INDIRECT, SPECIAL, INCIDENTAL, OR CONSEQUENTIAL DAMAGES.

Please read the User's Guide and, specifically, the Warnings and Restrictions notice in the User's Guide prior to handling the product. This notice contains important safety information about temperatures and voltages. For additional information on TI's environmental and/or safety programs, please visit www.ti.com/esh or contact TI.

No license is granted under any patent right or other intellectual property right of TI covering or relating to any machine, process, or combination in which such TI products or services might be or are used. TI currently deals with a variety of customers for products, and therefore our arrangement with the user is not exclusive. TI assumes no liability for applications assistance, customer product design, software performance, or infringement of patents or services described herein.

REGULATORY COMPLIANCE INFORMATION

As noted in the EVM User's Guide and/or EVM itself, this EVM and/or accompanying hardware may or may not be subject to the Federal Communications Commission (FCC) and Industry Canada (IC) rules.

For EVMs **not** subject to the above rules, this evaluation board/kit/module is intended for use for ENGINEERING DEVELOPMENT, DEMONSTRATION OR EVALUATION PURPOSES ONLY and is not considered by TI to be a finished end product fit for general consumer use. It generates, uses, and can radiate radio frequency energy and has not been tested for compliance with the limits of computing devices pursuant to part 15 of FCC or ICES-003 rules, which are designed to provide reasonable protection against radio frequency interference. Operation of the equipment may cause interference with radio communications, in which case the user at his own expense will be required to take whatever measures may be required to correct this interference.

General Statement for EVMs including a radio

User Power/Frequency Use Obligations: This radio is intended for development/professional use only in legally allocated frequency and power limits. Any use of radio frequencies and/or power availability of this EVM and its development application(s) must comply with local laws governing radio spectrum allocation and power limits for this evaluation module. It is the user's sole responsibility to only operate this radio in legally acceptable frequency space and within legally mandated power limitations. Any exceptions to this are strictly prohibited and unauthorized by Texas Instruments unless user has obtained appropriate experimental/development licenses from local regulatory authorities, which is responsibility of user including its acceptable authorization.

For EVMs annotated as FCC – FEDERAL COMMUNICATIONS COMMISSION Part 15 Compliant

Caution

This device complies with part 15 of the FCC Rules. Operation is subject to the following two conditions: (1) This device may not cause harmful interference, and (2) this device must accept any interference received, including interference that may cause undesired operation.

Changes or modifications not expressly approved by the party responsible for compliance could void the user's authority to operate the equipment.

FCC Interference Statement for Class A EVM devices

This equipment has been tested and found to comply with the limits for a Class A digital device, pursuant to part 15 of the FCC Rules. These limits are designed to provide reasonable protection against harmful interference when the equipment is operated in a commercial environment. This equipment generates, uses, and can radiate radio frequency energy and, if not installed and used in accordance with the instruction manual, may cause harmful interference to radio communications. Operation of this equipment in a residential area is likely to cause harmful interference in which case the user will be required to correct the interference at his own expense.

FCC Interference Statement for Class B EVM devices

This equipment has been tested and found to comply with the limits for a Class B digital device, pursuant to part 15 of the FCC Rules. These limits are designed to provide reasonable protection against harmful interference in a residential installation. This equipment generates, uses and can radiate radio frequency energy and, if not installed and used in accordance with the instructions, may cause harmful interference to radio communications. However, there is no guarantee that interference will not occur in a particular installation. If this equipment does cause harmful interference to radio or television reception, which can be determined by turning the equipment off and on, the user is encouraged to try to correct the interference by one or more of the following measures:

- Reorient or relocate the receiving antenna.
- Increase the separation between the equipment and receiver.
- Connect the equipment into an outlet on a circuit different from that to which the receiver is connected.
- Consult the dealer or an experienced radio/TV technician for help.

For EVMs annotated as IC – INDUSTRY CANADA Compliant

This Class A or B digital apparatus complies with Canadian ICES-003.

Changes or modifications not expressly approved by the party responsible for compliance could void the user's authority to operate the equipment.

Concerning EVMs including radio transmitters

This device complies with Industry Canada licence-exempt RSS standard(s). Operation is subject to the following two conditions: (1) this device may not cause interference, and (2) this device must accept any interference, including interference that may cause undesired operation of the device.

Concerning EVMs including detachable antennas

Under Industry Canada regulations, this radio transmitter may only operate using an antenna of a type and maximum (or lesser) gain approved for the transmitter by Industry Canada. To reduce potential radio interference to other users, the antenna type and its gain should be so chosen that the equivalent isotropically radiated power (e.i.r.p.) is not more than that necessary for successful communication.

This radio transmitter has been approved by Industry Canada to operate with the antenna types listed in the user guide with the maximum permissible gain and required antenna impedance for each antenna type indicated. Antenna types not included in this list, having a gain greater than the maximum gain indicated for that type, are strictly prohibited for use with this device.

Cet appareil numérique de la classe A ou B est conforme à la norme NMB-003 du Canada.

Les changements ou les modifications pas expressément approuvés par la partie responsable de la conformité ont pu vider l'autorité de l'utilisateur pour actionner l'équipement.

Concernant les EVMs avec appareils radio

Le présent appareil est conforme aux CNR d'Industrie Canada applicables aux appareils radio exempts de licence. L'exploitation est autorisée aux deux conditions suivantes : (1) l'appareil ne doit pas produire de brouillage, et (2) l'utilisateur de l'appareil doit accepter tout brouillage radioélectrique subi, même si le brouillage est susceptible d'en compromettre le fonctionnement.

Concernant les EVMs avec antennes détachables

Conformément à la réglementation d'Industrie Canada, le présent émetteur radio peut fonctionner avec une antenne d'un type et d'un gain maximal (ou inférieur) approuvé pour l'émetteur par Industrie Canada. Dans le but de réduire les risques de brouillage radioélectrique à l'intention des autres utilisateurs, il faut choisir le type d'antenne et son gain de sorte que la puissance isotrope rayonnée équivalente (p.i.r.e.) ne dépasse pas l'intensité nécessaire à l'établissement d'une communication satisfaisante.

Le présent émetteur radio a été approuvé par Industrie Canada pour fonctionner avec les types d'antenne énumérés dans le manuel d'usage et ayant un gain admissible maximal et l'impédance requise pour chaque type d'antenne. Les types d'antenne non inclus dans cette liste, ou dont le gain est supérieur au gain maximal indiqué, sont strictement interdits pour l'exploitation de l'émetteur.

【Important Notice for Users of this Product in Japan】

This development kit is NOT certified as Confirming to Technical Regulations of Radio Law of Japan

If you use this product in Japan, you are required by Radio Law of Japan to follow the instructions below with respect to this product:

1. Use this product in a shielded room or any other test facility as defined in the notification #173 issued by Ministry of Internal Affairs and Communications on March 28, 2006, based on Sub-section 1.1 of Article 6 of the Ministry's Rule for Enforcement of Radio Law of Japan,
2. Use this product only after you obtained the license of Test Radio Station as provided in Radio Law of Japan with respect to this product, or
3. Use of this product only after you obtained the Technical Regulations Conformity Certification as provided in Radio Law of Japan with respect to this product. Also, please do not transfer this product, unless you give the same notice above to the transferee. Please note that if you could not follow the instructions above, you will be subject to penalties of Radio Law of Japan.

Texas Instruments Japan Limited
(address) 24-1, Nishi-Shinjuku 6 chome, Shinjuku-ku, Tokyo, Japan

<http://www.tij.co.jp>

【ご使用にあたっての注】

本開発キットは技術基準適合証明を受けておりません。

本製品のご使用に際しては、電波法遵守のため、以下のいずれかの措置を取っていただく必要がありますのでご注意ください。

1. 電波法施行規則第6条第1項第1号に基づく平成18年3月28日総務省告示第173号で定められた電波暗室等の試験設備でご使用いただく。
2. 実験局の免許を取得後ご使用いただく。
3. 技術基準適合証明を取得後ご使用いただく。

なお、本製品は、上記の「ご使用にあたっての注意」を譲渡先、移転先に通知しない限り、譲渡、移転できないものとします。

上記を遵守頂けない場合は、電波法の罰則が適用される可能性があることをご留意ください。

日本テキサス・インスツルメンツ株式会社
東京都新宿区西新宿6丁目24番1号
西新宿三井ビル

<http://www.tij.co.jp>

EVALUATION BOARD/KIT/MODULE (EVM) WARNINGS, RESTRICTIONS AND DISCLAIMERS

For Feasibility Evaluation Only, in Laboratory/Development Environments. Unless otherwise indicated, this EVM is not a finished electrical equipment and not intended for consumer use. It is intended solely for use for preliminary feasibility evaluation in laboratory/development environments by technically qualified electronics experts who are familiar with the dangers and application risks associated with handling electrical mechanical components, systems and subsystems. It should not be used as all or part of a finished end product.

Your Sole Responsibility and Risk. You acknowledge, represent and agree that:

1. You have unique knowledge concerning Federal, State and local regulatory requirements (including but not limited to Food and Drug Administration regulations, if applicable) which relate to your products and which relate to your use (and/or that of your employees, affiliates, contractors or designees) of the EVM for evaluation, testing and other purposes.
2. You have full and exclusive responsibility to assure the safety and compliance of your products with all such laws and other applicable regulatory requirements, and also to assure the safety of any activities to be conducted by you and/or your employees, affiliates, contractors or designees, using the EVM. Further, you are responsible to assure that any interfaces (electronic and/or mechanical) between the EVM and any human body are designed with suitable isolation and means to safely limit accessible leakage currents to minimize the risk of electrical shock hazard.
3. You will employ reasonable safeguards to ensure that your use of the EVM will not result in any property damage, injury or death, even if the EVM should fail to perform as described or expected.
4. You will take care of proper disposal and recycling of the EVM's electronic components and packing materials.

Certain Instructions. It is important to operate this EVM within TI's recommended specifications and environmental considerations per the user guidelines. Exceeding the specified EVM ratings (including but not limited to input and output voltage, current, power, and environmental ranges) may cause property damage, personal injury or death. If there are questions concerning these ratings please contact a TI field representative prior to connecting interface electronics including input power and intended loads. Any loads applied outside of the specified output range may result in unintended and/or inaccurate operation and/or possible permanent damage to the EVM and/or interface electronics. Please consult the EVM User's Guide prior to connecting any load to the EVM output. If there is uncertainty as to the load specification, please contact a TI field representative. During normal operation, some circuit components may have case temperatures greater than 60°C as long as the input and output are maintained at a normal ambient operating temperature. These components include but are not limited to linear regulators, switching transistors, pass transistors, and current sense resistors which can be identified using the EVM schematic located in the EVM User's Guide. When placing measurement probes near these devices during normal operation, please be aware that these devices may be very warm to the touch. As with all electronic evaluation tools, only qualified personnel knowledgeable in electronic measurement and diagnostics normally found in development environments should use these EVMs.

Agreement to Defend, Indemnify and Hold Harmless. You agree to defend, indemnify and hold TI, its licensors and their representatives harmless from and against any and all claims, damages, losses, expenses, costs and liabilities (collectively, "Claims") arising out of or in connection with any use of the EVM that is not in accordance with the terms of the agreement. This obligation shall apply whether Claims arise under law of tort or contract or any other legal theory, and even if the EVM fails to perform as described or expected.

Safety-Critical or Life-Critical Applications. If you intend to evaluate the components for possible use in safety critical applications (such as life support) where a failure of the TI product would reasonably be expected to cause severe personal injury or death, such as devices which are classified as FDA Class III or similar classification, then you must specifically notify TI of such intent and enter into a separate Assurance and Indemnity Agreement.

Mailing Address: Texas Instruments, Post Office Box 655303, Dallas, Texas 75265
Copyright © 2012, Texas Instruments Incorporated

IMPORTANT NOTICE

Texas Instruments Incorporated and its subsidiaries (TI) reserve the right to make corrections, enhancements, improvements and other changes to its semiconductor products and services per JESD46, latest issue, and to discontinue any product or service per JESD48, latest issue. Buyers should obtain the latest relevant information before placing orders and should verify that such information is current and complete. All semiconductor products (also referred to herein as "components") are sold subject to TI's terms and conditions of sale supplied at the time of order acknowledgment.

TI warrants performance of its components to the specifications applicable at the time of sale, in accordance with the warranty in TI's terms and conditions of sale of semiconductor products. Testing and other quality control techniques are used to the extent TI deems necessary to support this warranty. Except where mandated by applicable law, testing of all parameters of each component is not necessarily performed.

TI assumes no liability for applications assistance or the design of Buyers' products. Buyers are responsible for their products and applications using TI components. To minimize the risks associated with Buyers' products and applications, Buyers should provide adequate design and operating safeguards.

TI does not warrant or represent that any license, either express or implied, is granted under any patent right, copyright, mask work right, or other intellectual property right relating to any combination, machine, or process in which TI components or services are used. Information published by TI regarding third-party products or services does not constitute a license to use such products or services or a warranty or endorsement thereof. Use of such information may require a license from a third party under the patents or other intellectual property of the third party, or a license from TI under the patents or other intellectual property of TI.

Reproduction of significant portions of TI information in TI data books or data sheets is permissible only if reproduction is without alteration and is accompanied by all associated warranties, conditions, limitations, and notices. TI is not responsible or liable for such altered documentation. Information of third parties may be subject to additional restrictions.

Resale of TI components or services with statements different from or beyond the parameters stated by TI for that component or service voids all express and any implied warranties for the associated TI component or service and is an unfair and deceptive business practice. TI is not responsible or liable for any such statements.

Buyer acknowledges and agrees that it is solely responsible for compliance with all legal, regulatory and safety-related requirements concerning its products, and any use of TI components in its applications, notwithstanding any applications-related information or support that may be provided by TI. Buyer represents and agrees that it has all the necessary expertise to create and implement safeguards which anticipate dangerous consequences of failures, monitor failures and their consequences, lessen the likelihood of failures that might cause harm and take appropriate remedial actions. Buyer will fully indemnify TI and its representatives against any damages arising out of the use of any TI components in safety-critical applications.

In some cases, TI components may be promoted specifically to facilitate safety-related applications. With such components, TI's goal is to help enable customers to design and create their own end-product solutions that meet applicable functional safety standards and requirements. Nonetheless, such components are subject to these terms.

No TI components are authorized for use in FDA Class III (or similar life-critical medical equipment) unless authorized officers of the parties have executed a special agreement specifically governing such use.

Only those TI components which TI has specifically designated as military grade or "enhanced plastic" are designed and intended for use in military/aerospace applications or environments. Buyer acknowledges and agrees that any military or aerospace use of TI components which have **not** been so designated is solely at the Buyer's risk, and that Buyer is solely responsible for compliance with all legal and regulatory requirements in connection with such use.

TI has specifically designated certain components which meet ISO/TS16949 requirements, mainly for automotive use. Components which have not been so designated are neither designed nor intended for automotive use; and TI will not be responsible for any failure of such components to meet such requirements.

Products

Audio	www.ti.com/audio
Amplifiers	amplifier.ti.com
Data Converters	dataconverter.ti.com
DLP® Products	www.dlp.com
DSP	dsp.ti.com
Clocks and Timers	www.ti.com/clocks
Interface	interface.ti.com
Logic	logic.ti.com
Power Mgmt	power.ti.com
Microcontrollers	microcontroller.ti.com
RFID	www.ti-rfid.com
OMAP Applications Processors	www.ti.com/omap
Wireless Connectivity	www.ti.com/wirelessconnectivity

Applications

Automotive and Transportation	www.ti.com/automotive
Communications and Telecom	www.ti.com/communications
Computers and Peripherals	www.ti.com/computers
Consumer Electronics	www.ti.com/consumer-apps
Energy and Lighting	www.ti.com/energy
Industrial	www.ti.com/industrial
Medical	www.ti.com/medical
Security	www.ti.com/security
Space, Avionics and Defense	www.ti.com/space-avionics-defense
Video and Imaging	www.ti.com/video

TI E2E Community

e2e.ti.com