

### SFP-10G-LR100-4135-C

Cisco® SFP-10G-LR100-4135 Compatible TAA 10GBase-DWDM SFP+ Transceiver C-Band Channel DW45 100GHz (SMF, 1541.35nm, 100km, LC, DOM)

#### Features:

- SFF-8432 and SFF-8472 Compliance
- Duplex LC Connector
- Single-mode Fiber
- Commercial Temperature 0 to 70 Celsius
- Hot Pluggable
- Metal with Lower EMI
- Excellent ESD Protection
- RoHS Compliant and Lead Free



#### Applications:

- 10x Gigabit Ethernet over DWDM
- 8x/10x Fibre Channel
- Access, Metro and Enterprise

#### Product Description

This Cisco® SFP-10G-LR100-4135 compatible SFP+ transceiver provides 10GBase-DWDM throughput up to 100km over single-mode fiber (SMF) using a wavelength of 1541.35nm via an LC connector. It is guaranteed to be 100% compatible with the equivalent Cisco® transceiver. This easy to install, hot swappable transceiver has been programmed, uniquely serialized and data-traffic and application tested to ensure that it will initialize and perform identically. Digital optical monitoring (DOM) support is also present to allow access to real-time operating parameters. This transceiver is Trade Agreements Act (TAA) compliant. We stand behind the quality of our products and proudly offer a limited lifetime warranty.

ProLabs' transceivers are RoHS compliant and lead-free.

TAA refers to the Trade Agreements Act (19 U.S.C. & 2501-2581), which is intended to foster fair and open international trade. TAA requires that the U.S. Government may acquire only "U.S. – made or designated country end products."



### Regulatory Compliance

- ESD to the Electrical PINs: compatible with MIL-STD-883E Method 3015.4
- ESD to the LC Receptacle: compatible with IEC 61000-4-3
- EMI/EMC compatible with FCC Part 15 Subpart B Rules, EN55022:2010
- Laser Eye Safety compatible with FDA 21CFR, EN60950-1& EN (IEC) 60825-1,2
- RoHS compliant with EU RoHS 2.0 directive 2015/863/EU

### DWDM Available Wavelengths

Channel #	Frequency (THZ)	Center Wavelength (nm)
61	196.1	1528.77
60	196.0	1529.55
59	195.9	1530.33
58	195.8	1531.12
57	195.7	1531.90
56	195.6	1532.68
55	195.5	1533.47
54	195.4	1534.25
53	195.3	1535.04
52	195.2	1535.82
51	195.1	1536.61
50	195.0	1537.40
49	194.9	1538.19
48	194.8	1538.98
47	194.7	1539.77
46	194.6	1540.56
45	194.5	1541.35
44	194.4	1542.14
43	194.3	1542.94
42	194.2	1543.73
41	194.1	1544.53
40	194.0	1545.32
39	193.9	1546.12
38	193.8	1546.92
37	193.7	1547.72
36	193.6	1548.51
35	193.5	1549.32
34	193.4	1550.12

## Absolute Maximum Ratings

Parameter	Symbol	Min.	Max.	Unit
Maximum Supply Voltage	V <sub>CC</sub>	-0.5	4.0	V
Storage Temperature	T <sub>S</sub>	-40	85	°C
Operating Case Temperature	T <sub>C</sub>	0	70	°C
Operating Humidity	RH	5	95	%
Receiver Power	R <sub>MAX</sub>		-3	dBm
Maximum Bitrate	B <sub>max</sub>		11.3	Gbps

## Electrical Characteristics (TOP=25°C, V<sub>CC</sub>=3.3Volts)

Parameter	Symbol	Min.	Typ.	Max.	Unit	Notes	
Power Supply Voltage	V <sub>CC</sub>	3.135	3.30	3.465	V		
Power Supply Current	I <sub>CC</sub>		300	450	mA		
Power Consumption	P <sub>DISS</sub>		1.0	1.5	W		
<b>Transmitter</b>							
Differential data input swing	V <sub>in,pp</sub>	180		700	mVp-p		
Input differential impedance	Z <sub>in</sub>		100		Ω		
TX_FAULT	Transmitter Fault	V <sub>OH</sub>	2.0		V <sub>CCHOST</sub>	V	
	Normal Operation	V <sub>OL</sub>	0		0.8	V	
TX_DISABLE	Transmitter Disable	V <sub>IH</sub>	2.0		V <sub>CCHOST</sub>	V	
	Transmitter Enable	V <sub>IL</sub>	0		0.8	V	
<b>Receiver</b>							
Differential data output swing	V <sub>out, pp</sub>	300		850	mVp-p	1	
Output differential impedance	Z <sub>in</sub>		100		Ω		
Data Output Rise Time, Fall Time	t <sub>r</sub> , t <sub>f</sub>	28			ps	2	
RX_LOS	Loss of signal (LOS)	V <sub>OH</sub>	2.0	-	V <sub>CCHOST</sub>	V	3
	Normal Operation	V <sub>OL</sub>	0	-	0.8	V	3

### Notes:

1. Internally AC coupled but requires an external 100Ω differential load termination.
2. 20–80%.
3. LOS is an open collector output. Should be pulled up with 4.7KΩ on the host board.

## Optical Characteristics

Parameter	Symbol	Min.	Typ.	Max.	Unit	Notes
<b>Transmitter</b>						
Launch Optical Power	PO	+1.0		+4.0	dBm	1
Center Wavelength Range	$\lambda_c$	1528.77		1550.22	nm	
Center Wavelength Spacing			100		GHz	
Center Wavelength Tolerance	$\Delta\lambda_c$	-100		100	pm	
Extinction Ratio	EX	9.0			dB	2
Side Mode Suppression Ratio	SMSR	30			dB	
Spectral Width (-20dB)				1	nm	
Transmitter and Dispersion Penalty	TDP			4.0	dB	
Relative Intensity Noise	RIN			-128	dB/Hz	
Optical Return Loss Tolerance	ORLT			21	dB	
Pout @TX-Disable Asserted	$P_{off}$			-30	dBm	1
Eye Diagram	IEEE Std 802.3-2005 10Gb Ethernet 10GBASE-ZR compatible					
<b>Receiver</b>						
Center Wavelength	$\lambda_c$	1528		1565	nm	
Receiver Sensitivity ( $P_{avg}$ )	S			-26	dBm	3
Receiver Overload ( $P_{avg}$ )	$P_{OL}$	-7.0			dBm	3
Optical Return Loss	ORL			-27	dB	
OSNR		27			dB	4
Max OSNR Path Penalty				4	dB	4
Dispersion Limited Distance				100	Km	
LOS De-Assert	$LOS_D$			-26	dBm	
LOS Assert	$LOS_A$	-35			dBm	
LOS Hysteresis		0.5			dB	

### Notes:

1. The optical power is launched into 9/125 $\mu$ m SMF.
2. Measured with a PRBS  $2^{31}-1$  test pattern @10.3125Gbps.
3. Measured with PRBS  $2^{31}-1$  test pattern, 10.3125Gb/s, BER< $10^{-12}$ .
4. Receiver power@ -7~-18dBm, 10.3125Gb/s, BER< $10^{-12}$ .

## Pin Descriptions

Pin	Symbol	Name/Descriptions	Ref.
1	VeeT	Transmitter Ground (Common with Receiver Ground).	1
2	TX Fault	Transmitter Fault. LVTTTL-O	2
3	TX Disable	Transmitter Disable. Laser output disabled on high or open. LVTTTL-I.	3
4	SDA	2-Wire Serial Interface Data Line (Same as MOD-DEF2 in INF-8074i). LVTTTL-I/O.	
5	SCL	2-Wire Serial Interface Data Line (Same as MOD-DEF2 in INF-8074i). LVTTTL-I.	
6	MOD_ABS	Module Absent, Connect to VeeT or VeeR in Module.	4
7	RS0	Rate Select 0. Not used	5
8	LOS	Loss of Signal indication. Logic 0 indicates normal operation. LVTTTL-O.	2
9	RS1	Rate Select 1. Not used	5
10	VeeR	Receiver Ground (Common with Transmitter Ground).	1
11	VeeR	Receiver Ground (Common with Transmitter Ground).	1
12	RD-	Receiver Inverted DATA out. AC Coupled. CML-O.	
13	RD+	Receiver Non-inverted DATA out. AC Coupled. CML-O.	
14	VeeR	Receiver Ground (Common with Transmitter Ground).	1
15	VccR	Receiver Power Supply.	
16	VccT	Transmitter Power Supply.	
17	VeeT	Transmitter Ground (Common with Receiver Ground).	1
18	TD+	Transmitter Non-Inverted DATA in. AC Coupled. CML-I.	
19	TD-	Transmitter Inverted DATA in. AC Coupled. CML-O.	
20	VeeT	Transmitter Ground (Common with Receiver Ground).	1

### Notes:

1. The module signal ground contacts, VeeR and VeeT, should be isolated from the module case.
2. This contact is an open collector/drain output and should be pulled up to the Vcc\_Host with resistor in the range 4.7KΩ to 10KΩ. Pull ups can be connected to one or several power supplies, however the host board design shall ensure that no module contract has voltage exceeding module VccT/R +0.5.V.
3. Tx\_Disable is an input contact with a 4.7KΩ to 10KΩ pull-up resistor to VccT inside module.
4. Mod\_ABS is connected to VeeT or VeeR in the SFP+ module. The host may pull the contract up to Vcc\_Host with a resistor in the range from 4.7KΩ to 10KΩ. Mod\_ABS is asserted "High" when the SFP+ module is physically absent from a host slot.
5. Internally pulled down per SFF-8431

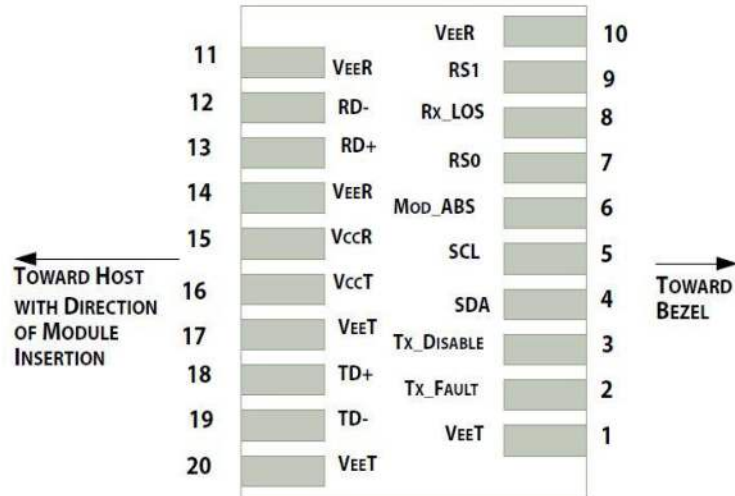

Pin-out of connector Block on Host board

### Recommended Circuit Schematic

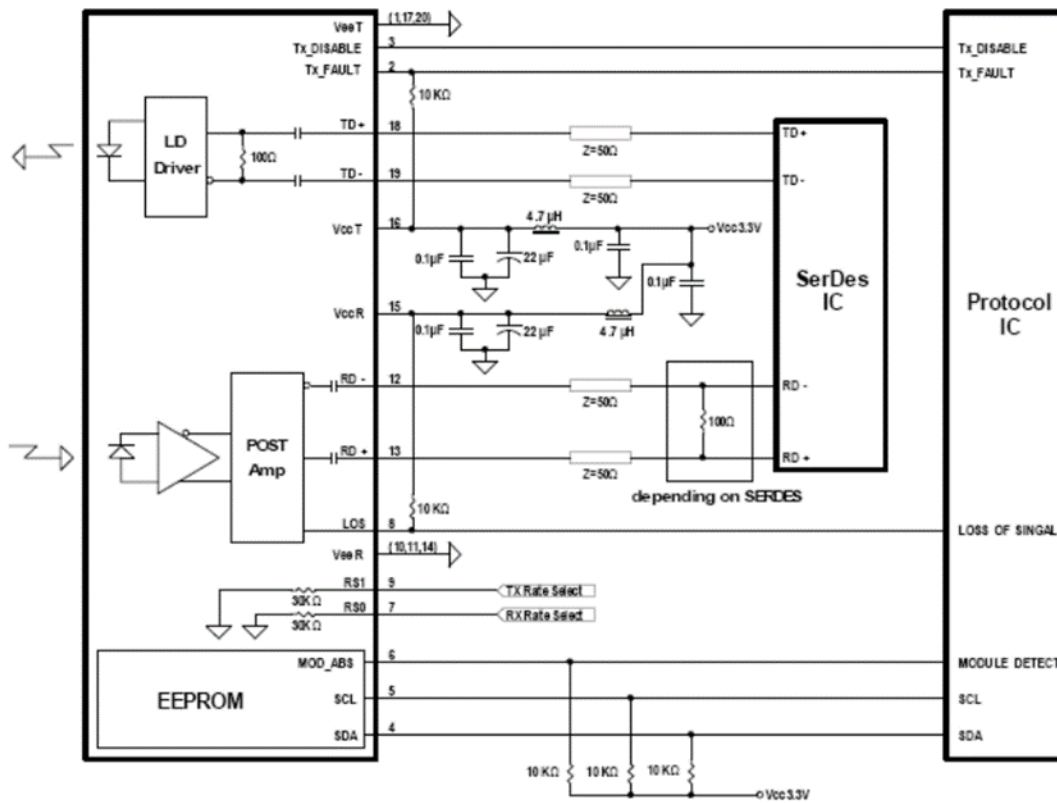

### Mechanical Specifications

Small Form Factor Pluggable (SFP) transceivers are compatible with the dimensions defined by the SFP Multi-Sourcing Agreement (MSA).

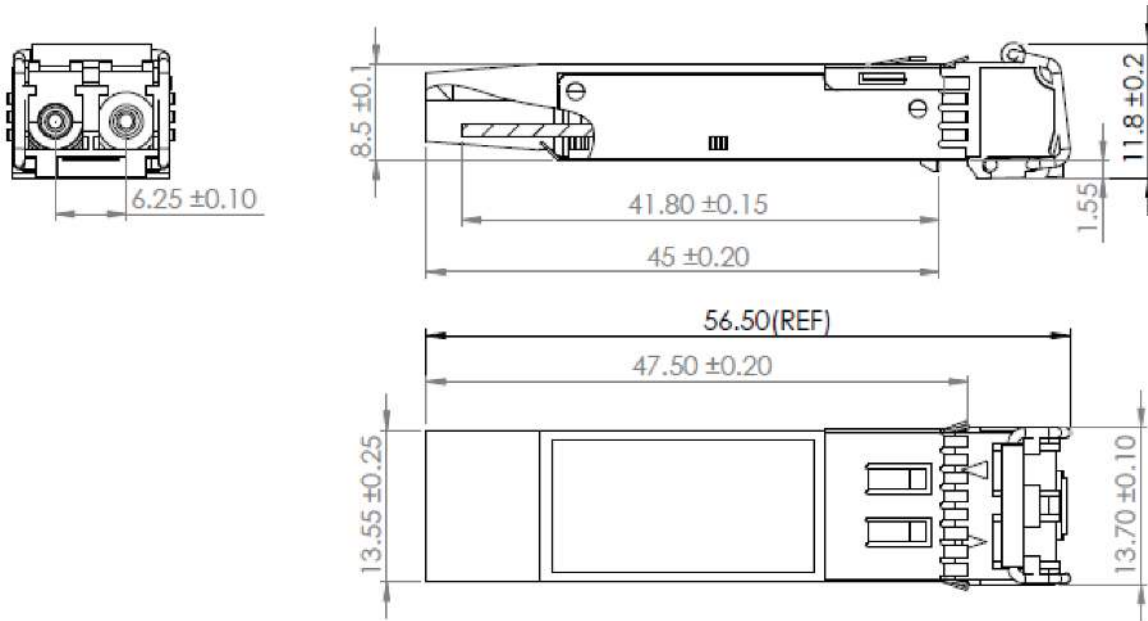

### EEPROM Information

EEPROM memory map specific data field description is as below:

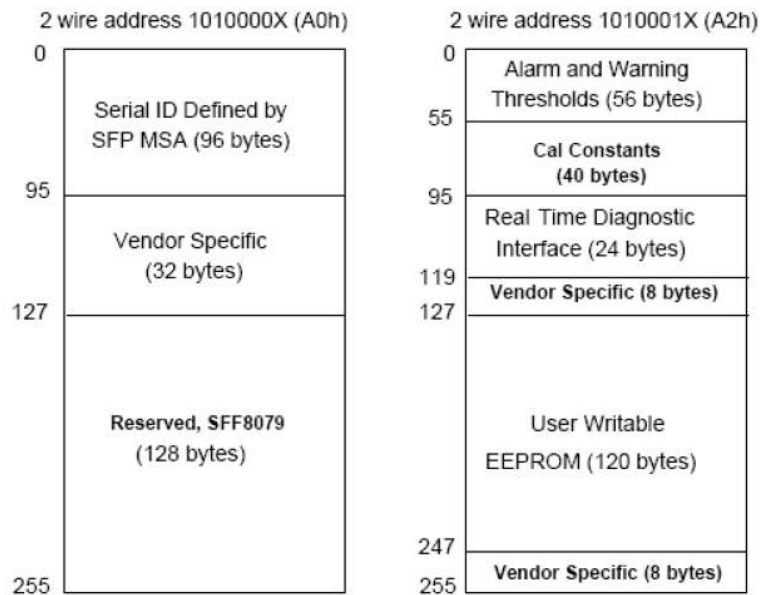

## **About ProLabs**

Our experience comes as standard; for over 15 years ProLabs has delivered optical connectivity solutions that give our customers freedom and choice through our ability to provide seamless interoperability. At the heart of our company is the ability to provide state-of-the-art optical transport and connectivity solutions that are compatible with over 90 optical switching and transport platforms.

## **Complete Portfolio of Network Solutions**

ProLabs is focused on innovations in optical transport and connectivity. The combination of our knowledge of optics and networking equipment enables ProLabs to be your single source for optical transport and connectivity solutions from 100Mb to 400G while providing innovative solutions that increase network efficiency. We provide the optical connectivity expertise that is compatible with and enhances your switching and transport equipment.

## **Trusted Partner**

Customer service is our number one value. ProLabs has invested in people, labs and manufacturing capacity to ensure that you get immediate answers to your questions and compatible product when needed. With Engineering and Manufacturing offices in the U.K. and U.S. augmented by field offices throughout the U.S., U.K. and Asia, ProLabs is able to be our customers best advocate 24 hours a day.

## **Contact Information**

ProLabs US

Email: [sales@prolabs.com](mailto:sales@prolabs.com)

Telephone: 952-852-0252

ProLabs UK

Email: [salessupport@prolabs.com](mailto:salessupport@prolabs.com)

Telephone: +44 1285 719 600