



SPECIFICATION SHEET

SPECIFICATION SHEET NO.	N0530-FM450K0000S112
DATE	May 30, 2021
REVISION	A0
DESCRIPTION	<p>KHz SMD Ceramic Filter 12065 Type L12.0*W6.5*H3.0mm, 4 Pads CFTC W Series 450.0KHz, Insertion Loss. 4.0dB Max.; 6dB Bandwidth: +/-12.0KHz Min. Group Delay Time (GDT) Ripple Deviation: 30.0 μSec. Max. @ F0 +/-8KHz Operating Temp. Range -20°C ~+80°C, Reflow Profile Condition 260 °C Max. Tape/Reel, RoHS/RoHS III compliant</p>
CUSTOMER	
CUSTOMER PART NUMBER	
CROSS REF. PART NUMBER	
ORIGINAL PART NUMBER	TGS CFTC 450KCW TLF
PART CODE	FM450K0000S112

VENDOR APPROVE			
Issued/Checked/Approved			
DATE: May 30, 2021			

CUSTOMER APPROVE	
DATE:	

KHZ SMD CERAMIC FILTER CFTC W SERIES

MAIN FEATURE

- KHz SMD Ceramic Filter 12065 Type 4 pads
- White case, L12.0*W6.5*H3.0mm
- Low cost and short shipment
- Reflow Profile Condition 260 °C Max.
- Cross more competitors part CFWKG
- Group Delay Time (GDT)
- RoHS/RoHS III compliant



APPLICATION

- Bluetooth, wireless communication set
- Communication Electronics

RFQ

[Request For Quotation](#)

PART CODE GUIDE

FM	450K0000	S	112
1	2	3	4

- 1) FM: Part family Code for KHz SMD Ceramic Filter 12065 Type L12.0*W6.5*H3.0mm 4 Pads CFTC W Series
- 2) 450K0000: Frequency range code for 450.0000KHz
- 3) S: SMD type, Package Tape/Reel, 1000pcs/Reel
- 4) 112: Specification code for original part No.: **TGS CFTC 450KCW TLF**

KHZ SMD CERAMIC FILTER CFTC W SERIES

DIMENSION (Unit: mm, Tol. +/-0.15mm)

Image for reference

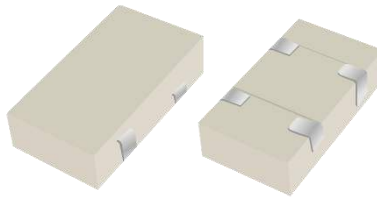

CFTC W

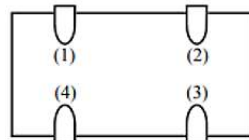
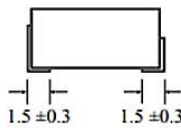
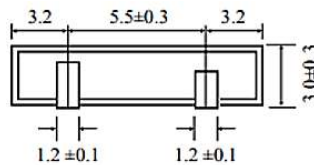
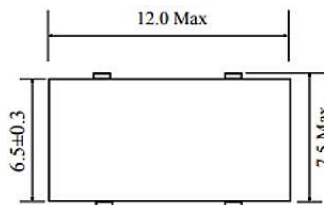

Marking

Line 1: Series Code
Line 2: Frequency Range
+Internal Code

Connection

Pad (1): Input
Pad (2): Output
Pad (3): Ground
Pad (4): Ground

Test Circuit

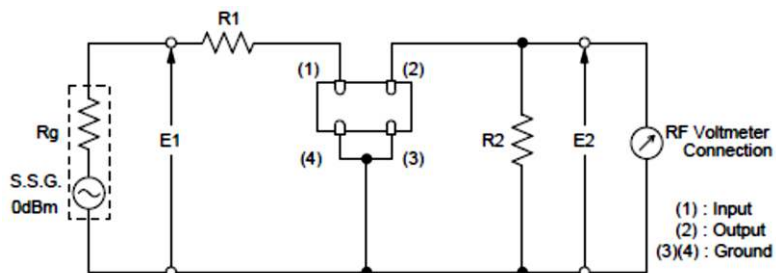

(1) : Input
(2) : Output
(3)(4) : Ground

$R_g + R_1 = R_2 = \text{Output/input Impedance}$

KHZ SMD CERAMIC FILTER CFTC W SERIES
ELECTRICAL PARAMETERS

Parameter	Part No. Symbol	Units	Value			Condition
			Min.	Typical	Max.	
Original Manufacturer	TGS	TGS Crystals				
Holder Type	CFTC	KHz SMD Ceramic Filter				
Frequency Range (f0)	450	KHz	450.00		@fo±1.0KHz, 6dB	
GDT Ripple deviation	K	µSec			30.0	@fo±8.0 kHz
Temperature Stability		%			±0.5	@ - 20°C ~ +80°C
Operation Temperance		°C	-20		+80	
Storage Temperance		°C	-40		+85	
Stop Band Attenuation		dB	45			@fo±100KHz
Bandwidth	C	KHz	±10.0			@3 dB
		KHz	±12.0			@6 dB
		KHz	±30.0			@50 dB
Insertion Loss (At minimum loss point)		dB			4.0	
Ripple		dB			1.0	@f0±8.0khz
Spurious Response		dB	20.0			@0.1~1.0MHz
Input/Output Impedance		Ω	1000			
Insulation Resistance		MΩ	100			@DC 25V 1 minute)
Pads Code	W		L12.0*W6.5*H3.0mm 4 Pads			
Other	Package	T	Tape/Reel, 1000pcs/Reel			
	RoHS Status	LF	RoHS III compliant			
	Add Value		N/A			
	Special Code		For Internal Control, Blank: N/A			

Note:

Original Part Number: TGS CFTC 450KCW TLF

4

KHZ SMD CERAMIC FILTER CFTC W SERIES

RELIABILITY

Test Items	Test Method And Conditions	Requirement
Humidity	After being placed in a chamber with 90-95% R.H. at 40±2°C for 100 hours and then being placed in room temperature for 1 hour, filter shall be measured.	It shall meet Table 1.
High Temperature	After being placed in a chamber with 80±2 °C, for 100 hours and then being placed in room temperature for 1 hour, filter shall be measured.	It shall meet Table 1.
Low Temperature	After being placed in a chamber with -20±2 °C, for 100 hours and then being placed in room temperature for 1 hour, filter shall be measured.	It shall meet Table 1.
Heat Shock	After being kept at room temperature, filter shall be placed at temperature of -55 °C , for 30 minutes, then be placed at temperature. 85 °C, for 30 minutes. After that returned to -55 °C again. Repeated above cycle for 5 times. After being kept in room temp. for 1 hour, filter shall be measured	It shall meet Table 1.
Resistance to Solder Heat	Lead terminals are immersed up to 1.5mm from filter’s body in soldering bath of 350± 10°C, for 3±0.5 sec. And then filter shall be measured after being placed in room temperature for 1 hour.	It shall meet Table 1.
Solderability	Lead terminals are immersed in aide solder for 5 sec and then immersed in soldering bath of 230±5°C, for 3±0.5 sec.	At least 95% lead terminals shall be covered with solder.
Drop Test	Filter shall be measured after 3 times random drops from the height of 30 cm on concrete floor	No visible damage and it meet Table 1
Adhesion	A static load of 20N to the direction of the arrow (see Fig. 4) shall be applied on the core of the Component and hold for 10 seconds. Filter shall be soldered correctly and tightly to PCB.	It shall meet Table 1.
Vibration	Filter shall be measured after being applied vibration of amplitude of 1.5mm with 10-55Hz band of vibration frequency to each of 3 perpendicular directions for 2 hours	No visible damage and it meet Table 1
Substrate Bending Test	Apply pressure in the direction of arrow (see Fig. 3) at a rate of about 0.5mm per second until it reaches a bend of 3mm and hold for 30 seconds.	It shall meet Table 1.

Table1

Item	Center Frequency	Band width (6dB)	Band width (50dB)	Stop Band Attenuation (fo±100KHz)	Ripple (fo±8KHz)	Insertion Loss
Specification	450±1.0 KHz Max.	±12.0 KHz Min.	±30.0 KHz Min.	45.0 dB Min.	1.0 dB Max	4.0 dB Max

KHZ SMD CERAMIC FILTER CFTC W SERIES

SUGGESTED REFLOW PROFILE (For Reference Only)



Profile Feature		Pb-Free Assembly
Average Ramp-up Rate (Ts Max to Tp)		3°C/second Max
Preheat	Temperature Min (Ts Min.)	125°C
	Temperature Max (Ts Max.)	200°C
	Time (ts Min. to ts Max.)	60 ~ 180 seconds
Time maintained above	Temperature (Tl)	217°C
	Time (tL)	60 ~ 150 seconds
Peak/Classification Temperature (Tp)		260 °C
Time within 5°C of actual Peak Temperature (tp)		20 ~ 40 seconds
Ramp-down rate		6 °C /Second Max.
Time 25 °C to Peak Temperature		8 minutes Max.
Suggest reflow times		3 Times Max.

KHZ SMD CERAMIC FILTER CFTC W SERIES

REEL DIMENSION (Unit: mm, 1000pcs/Reel)

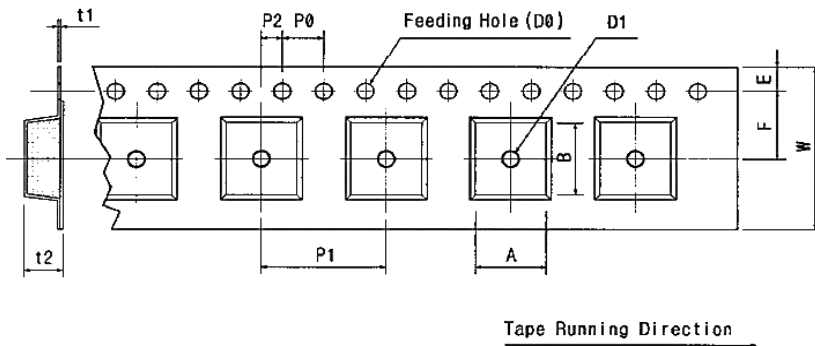

Code	Dimension
W	24.0+/-0.30
F	11.5+/-0.05
E	1.75+/-0.10
P 0	4.00+/-0.10
P 1	12.0+/-0.10
P 2	2.00+/-0.05
D 0	Ø1.5+/-0.10
D 1	Ø1.0+/-0.25
t 1	0.35+/-0.10
t 2	3.20+/-0.10
A	7.70+/-0.10
B	12.0+/-0.10

TAPE DIMENSION (Unit: mm)



Code	Dimension
A	Ø180+/-1.0
B	Ø60+/-0.5
C	Ø13.0+/-0.5
E	2.00+/-0.5
W	17.0+/-1.0
T	19.4+/-0.3



DISCLAIMER

NextGen Components, Inc. reserves the right to make changes to the product(s) and or information contained herein without notice. No liability is assumed as a result of their use or application. No rights under any patent accompany the sale of any such product(s) or information