

Active GPS/GLONASS/Beidou Ceramic Patch

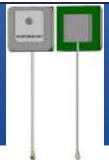

APARC2504A-SG3



ESD Sensitive



25.0 x 25.0 x 7.4 mm
RoHS/RoHS II Compliant
MSL = N/A

Features

- Multiband GPS/GLONASS/Beidou/GNSS patch
- Active GNSS patch with LNA max gain of 22 dB
- RHCP polarization
- 25.0 x 25.0 x 4.0 mm
- RF coax cable, IPEX connector

Applications

- GPS/GLONASS/Galileo/Beidou applications
- IoT
- M2M
- Remote technology monitoring
- Geofencing
- Surveying and mapping systems
- Logistics

System

This antenna system consists of two functional blocks, the LNA portion and the patch antenna.

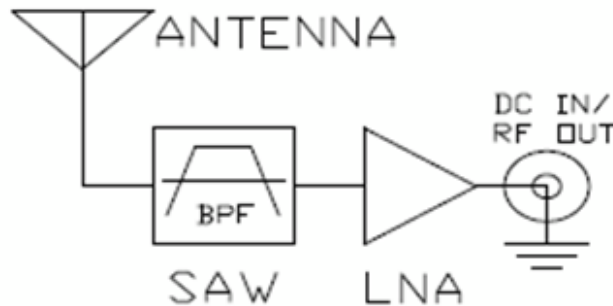

Electrical Characteristics

Antenna

Item	Spec
Frequency Range	1561.098± 2.046 MHz. 1575.42± 1.023 MHz. 1602± 5 MHz.
Gain	1561MHz: -1dBi Typ.@zenith 1575.42MHz: -2.5dBi Typ. @zenith 1602MHz: -1.5dBi Typ. @zenith
Polarization	RHCP

Active GPS/GLONASS/Beidou Ceramic Patch

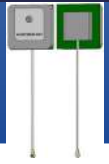

APARC2504A-SG3



ESD Sensitive



25.0 x 25.0 x 7.4 mm
RoHS/RoHS II Compliant
MSL = N/A

LNA

Item	Spec		
Input Voltage	Min: 1.8V	Typ: 3.0V	Max: 5.5V
Frequency Range	1558~1610 MHz		
Output Impedance	50Ω		
Outer Band Attenuation	1584 ± 50MHz 13dB Min 1584 ± 100MHz 20dB Min		
Pout at 1 dB gain Compression point	-6 dBm Min. -2 dBm Typ.		
Output VSWR	2.0 Max		
LNA Gain, Power Consumption and Noise Figure			
Voltage	LNA Gain (Typ.)	Power Consumption (mA) Typ.	Noise Figure (Typ.)
Min 1.8V	12dB	5mA	3.0dB
Typ 3.0V	18dB	10mA	2.8dB
Max 5.5V	22dB	23mA	3.0dB

Combined Electrical Specifications

Item	Spec
Frequency Range	1574~1610 MHz
Gain	At 90° 1561MHz: 17± 3dBi 1575.42MHz: 15.5± 3dBi 1602MHz: 16.5± 3dBi
Output Impedance	50Ω

Mechanical Specifications

Item	Spec
Antenna Dimensions	25.0 x 25.0 x 4.0 mm
RF Connector	I-PEX
RF Cable	RF Coaxial Cable, ψ 1.13± 0.1mm, (Color: GRAY) L = 69± 2 mm

Active GPS/GLONASS/Beidou Ceramic Patch

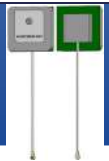

APARC2504A-SG3



ESD Sensitive



25.0 x 25.0 x 7.4 mm
RoHS/RoHS II Compliant
MSL = N/A

Dimensions

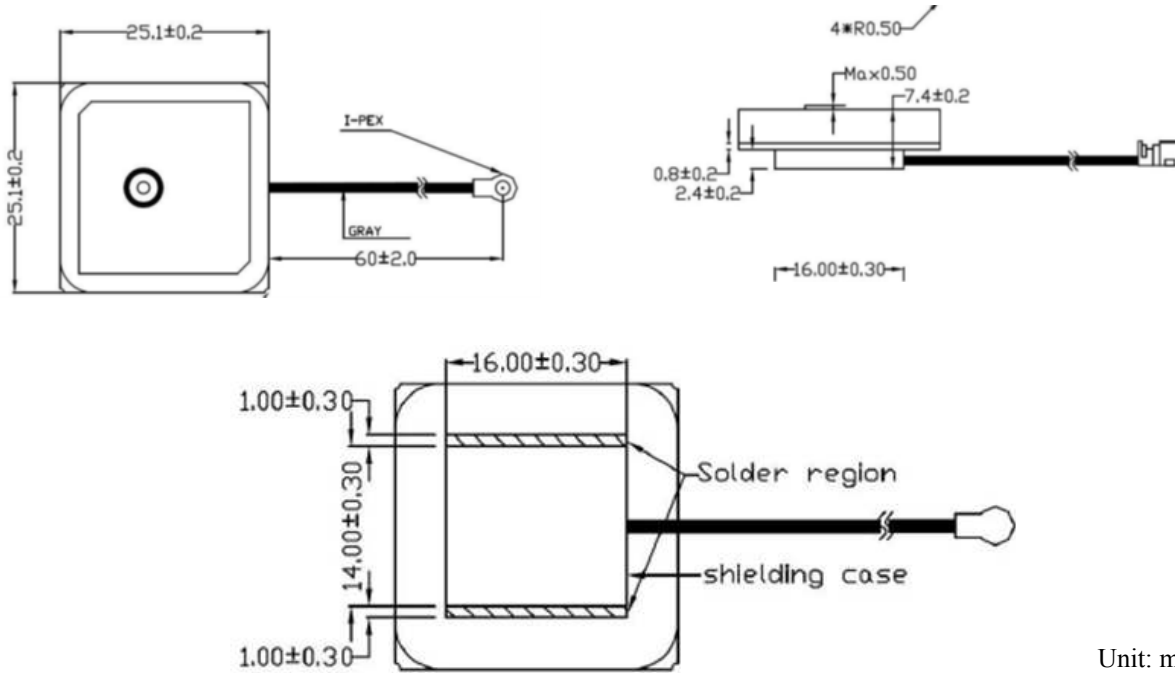

Unit: mm

LNA Gain and Out Band Rejection

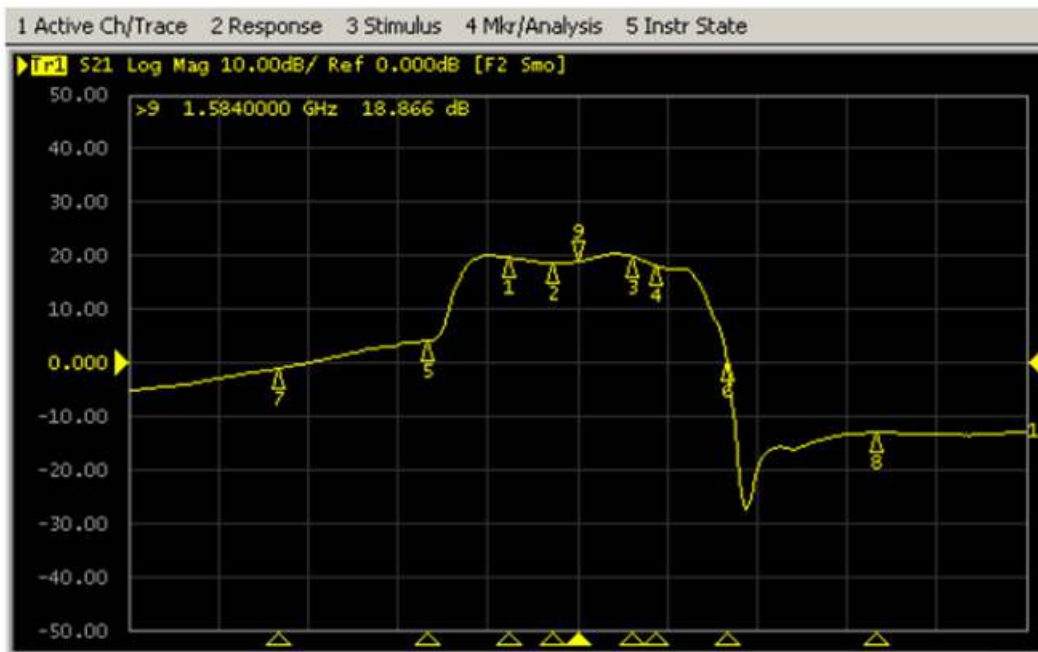

LNA Gain and Out Band Rejection @ 3.0V

Active GPS/GLONASS/Beidou Ceramic Patch

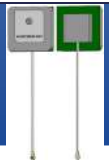

APARC2504A-SG3



ESD Sensitive



25.0 x 25.0 x 7.4 mm
RoHS/RoHS II Compliant
MSL = N/A

LNA Noise Figure

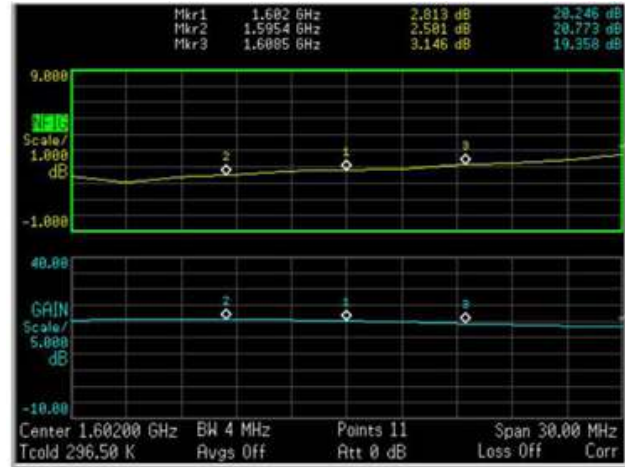
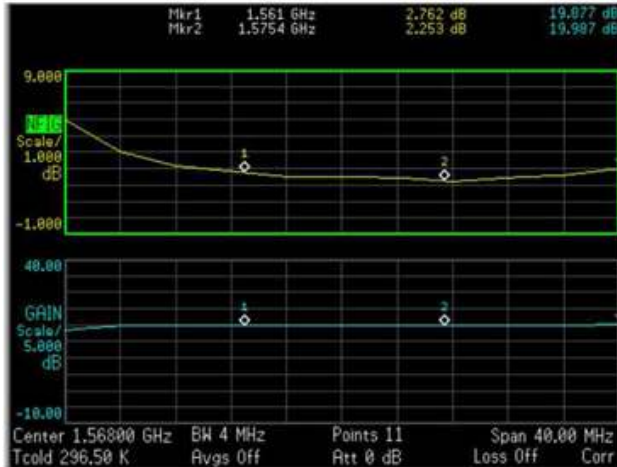

LNA Noise Figure @ 3.0V

S11/Return Loss Characteristics

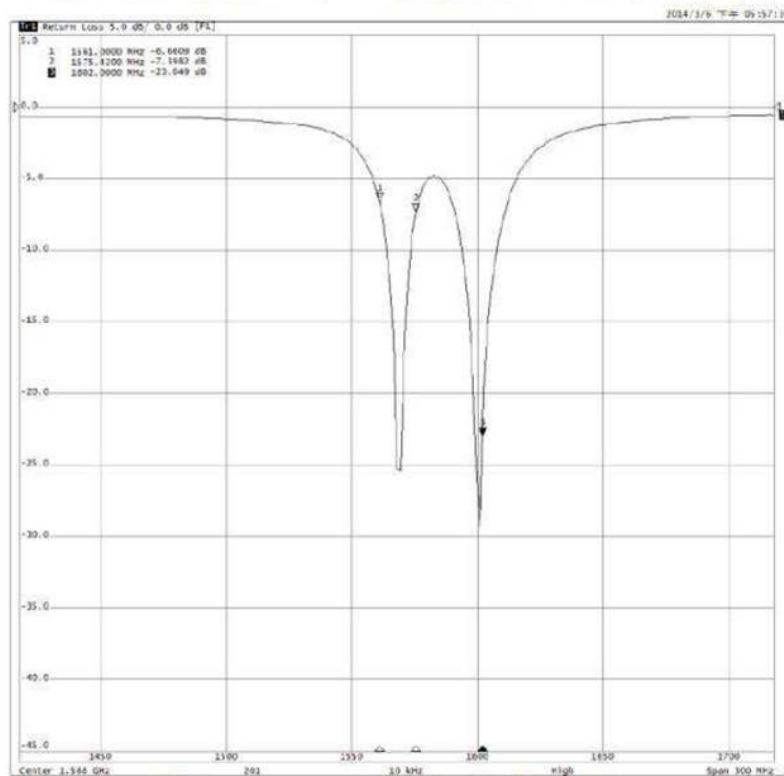

Return Loss : -6.66 @1561MHz
Return Loss : -7.39 @1575.42MHz
Return Loss : -23.04 @1602MHz

Active GPS/GLONASS/Beidou Ceramic Patch

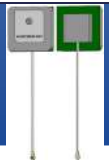

APARC2504A-SG3



ESD Sensitive



25.0 x 25.0 x 7.4 mm
RoHS/RoHS II Compliant
MSL = N/A

Smith Chart

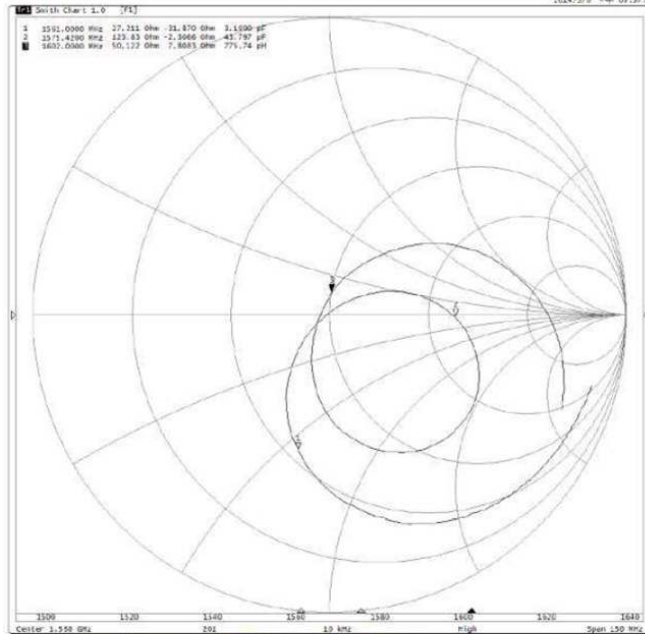

Impedance : 27.21 - j31.87 Ohm

Impedance : 123.83 - j 2.3- Ohm

Impedance : 50.12 + j7.80 Ohm

VSWR

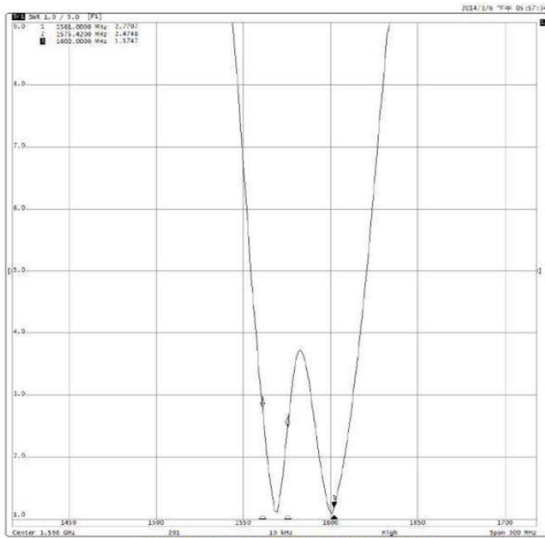

VSWR : 2.77 @1575.42MHz

VSWR : 2.47 @1575.42MHz

VSWR : 1.17 @1575.42MHz

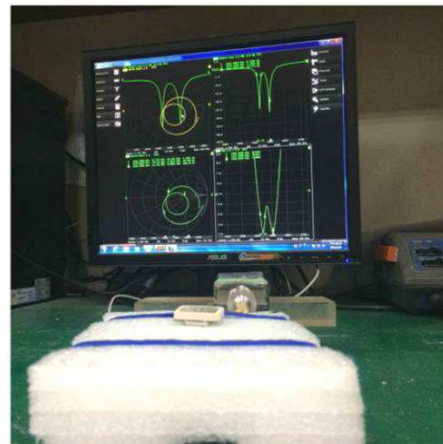

Active GPS/GLONASS/Beidou Ceramic Patch

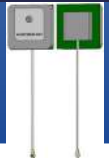

APARC2504A-SG3



ESD Sensitive



25.0 x 25.0 x 7.4 mm
RoHS/RoHS II Compliant
MSL = N/A

Radiation Patterns

XZ Plane

YZ Plane

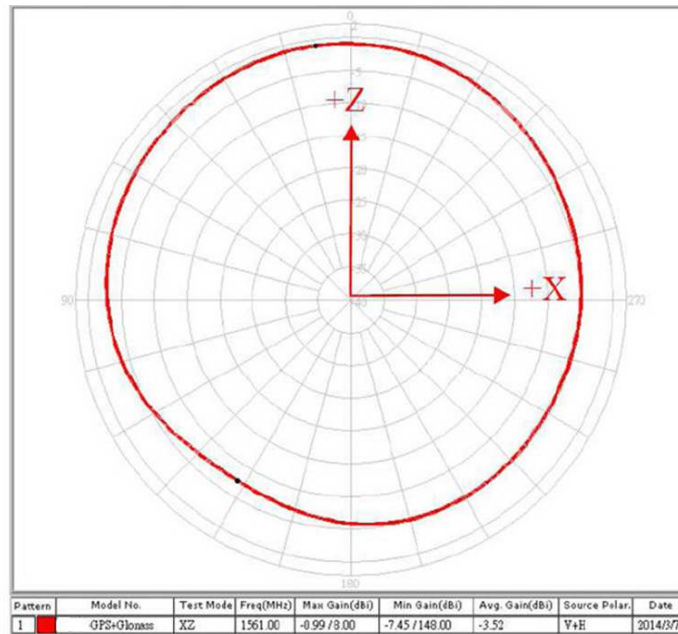
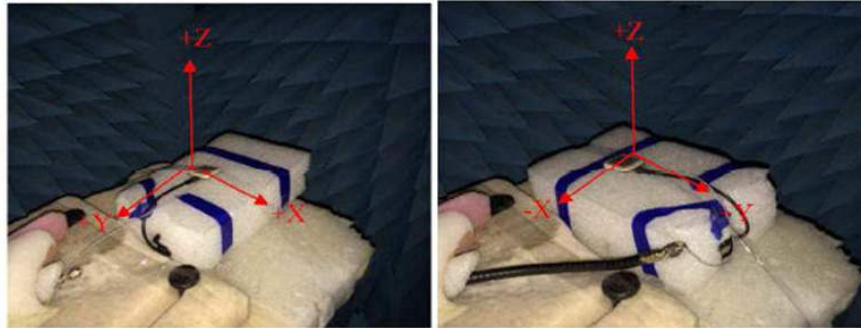

XZ-Plane@1561MHz

Active GPS/GLONASS/Beidou Ceramic Patch

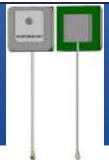

APARC2504A-SG3



ESD Sensitive



25.0 x 25.0 x 7.4 mm
RoHS/RoHS II Compliant
MSL = N/A

Radiation Patterns

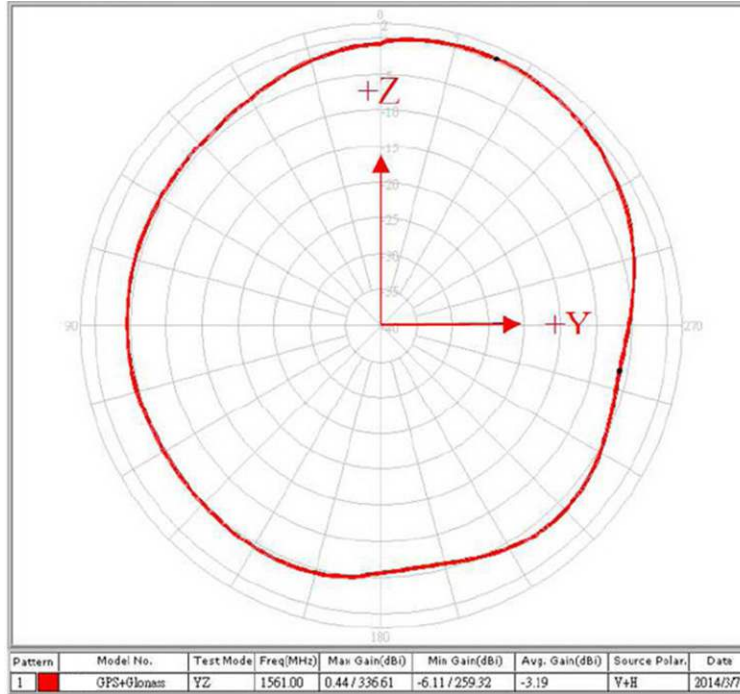

YZ-Plane@1561MHz

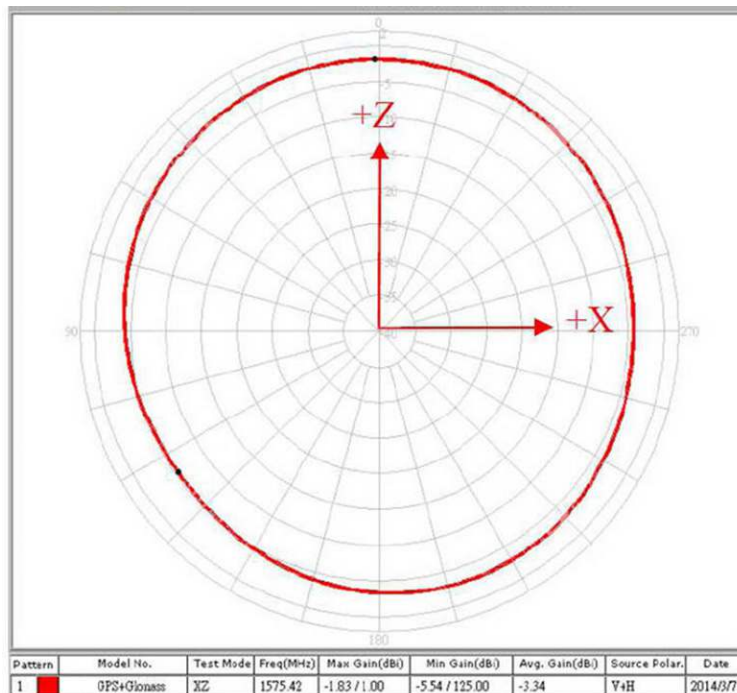

XZ-Plane@1575.42MHz

Active GPS/GLONASS/Beidou Ceramic Patch

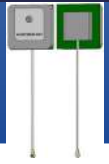

APARC2504A-SG3



ESD Sensitive



25.0 x 25.0 x 7.4 mm
RoHS/RoHS II Compliant
MSL = N/A

Radiation Patterns

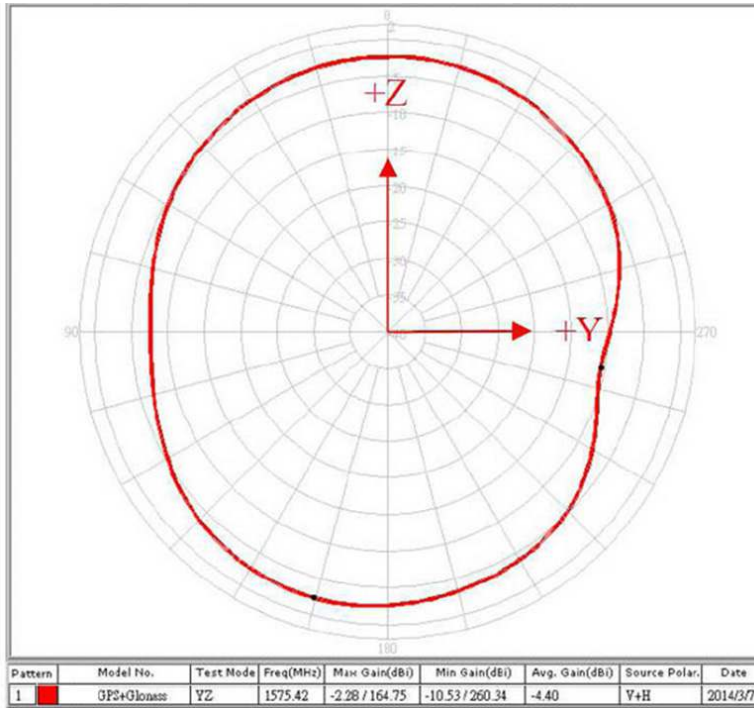

YZ-Plane@1575.42MHz

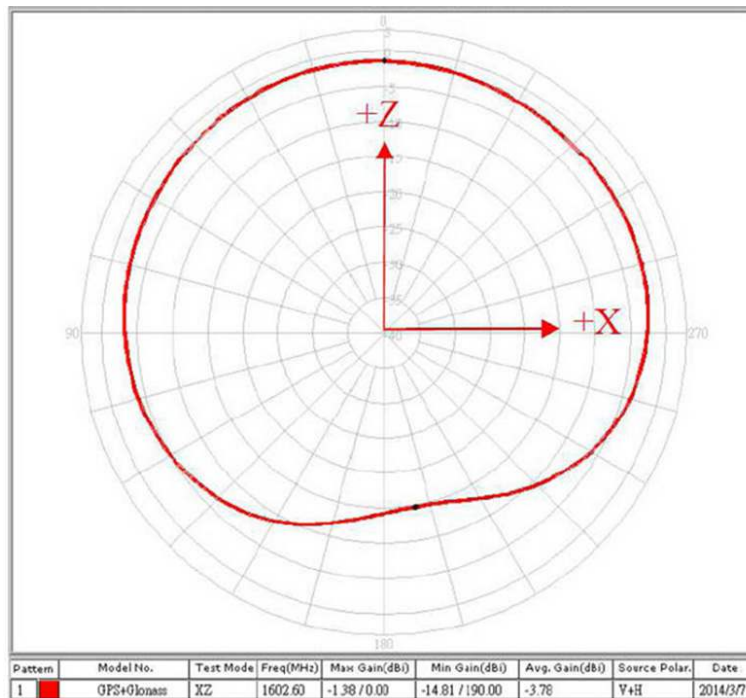

XZ-Plane@1602MHz

Active GPS/GLONASS/Beidou Ceramic Patch

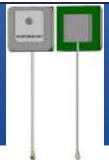

APARC2504A-SG3



ESD Sensitive



25.0 x 25.0 x 7.4 mm
RoHS/RoHS II Compliant
MSL = N/A

Radiation Patterns

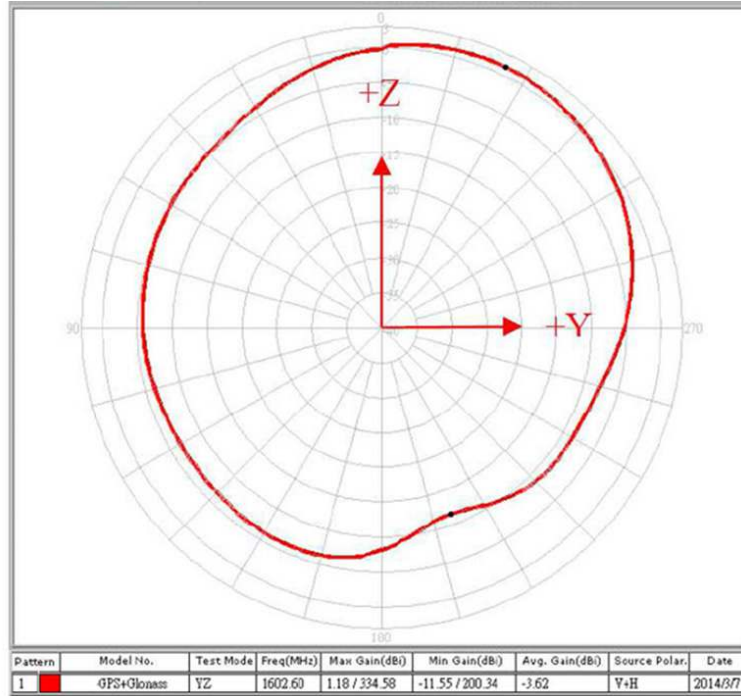

YZ-Plane@1602MHz

Radiation Patterns

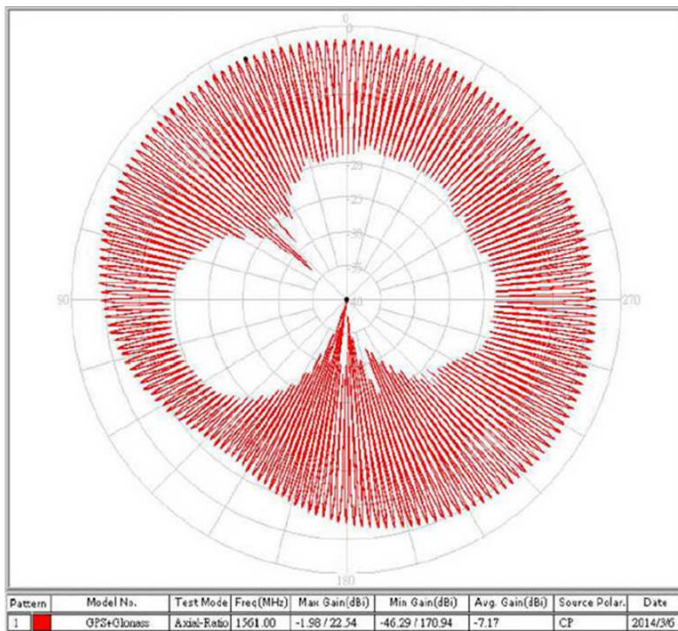

Axial Ratio@1561MHz

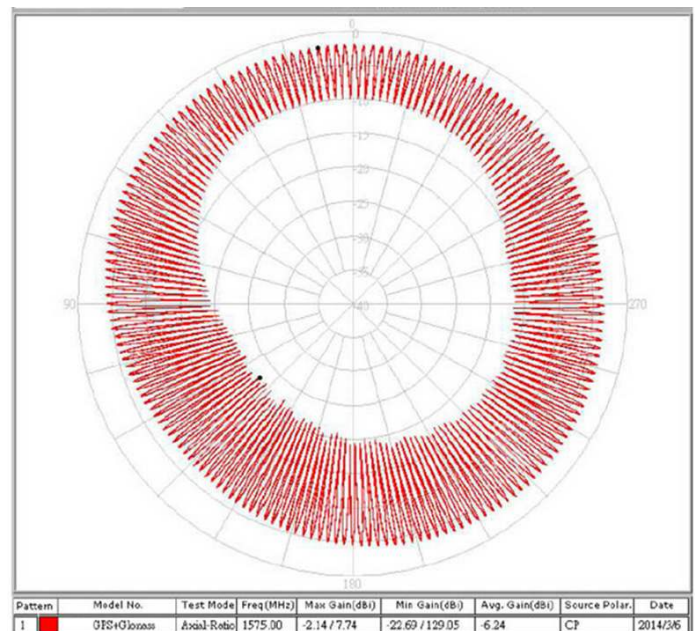

Axial Ratio@1575MHz

Active GPS/GLONASS/Beidou Ceramic Patch

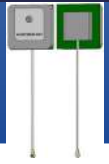

APARC2504A-SG3



ESD Sensitive



25.0 x 25.0 x 7.4 mm
RoHS/RoHS II Compliant
MSL = N/A

Radiation Patterns

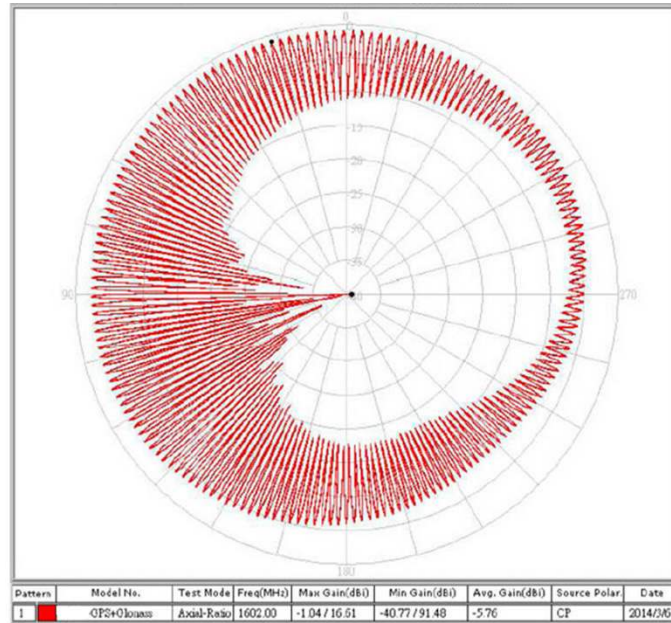

Axial Ratio@1602MHz

Environmental Conditions

Item	Spec
Operational Temperature	-40°C to + 85°C
Storage Temperature	-40°C to + 105°C
Relative Humidity	40% to 95%

Packaging

1. EPE foam – 52*43*5mm
2. Vacuum bag – 60*45mm/ 365*300*25mm/30pcs/anti-ESD
3. Plastic bag – 420*560*0.12mm/anti-ESD
4. Carton box – 390*320*290mm (450pcs/Carton)
5. GW – 7.62KG
6. MSL: Not Applicable

Active GPS/GLONASS/Beidou Ceramic Patch

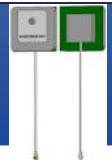

APARC2504A-SG3



ESD Sensitive



25.0 x 25.0 x 7.4 mm
RoHS/RoHS II Compliant
MSL = N/A

Plugs Usage Precautions

Mating / Unmating

To disconnect connectors, insert the end portion of I-PEX under the connector flanges and pull off vertically, in the direction of the connector mating axis. (2) To mate the connectors, the mating axes of both connectors must be aligned and the connectors can be mated. The “click” will confirm fully mated connection. Do not attempt to insert on an extreme angle

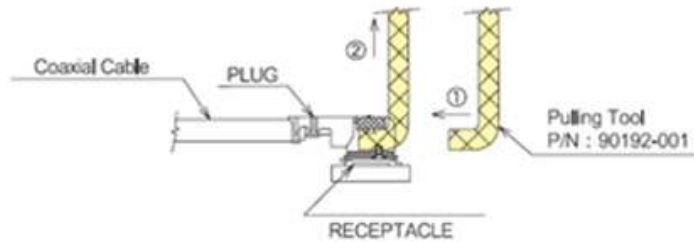

Pull forces on the cable after connectors are mated. After the connectors are mating, do not apply a load to the cable in excess of the values indicated in the diagram below.

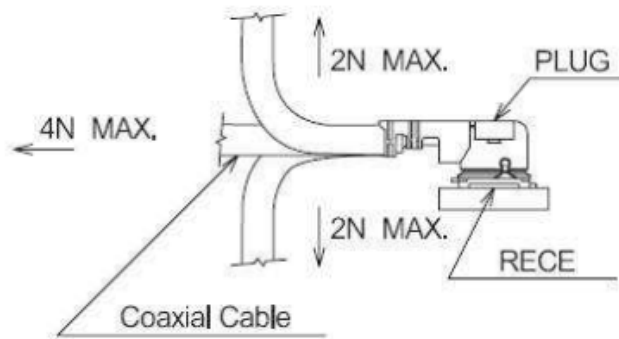

Test Setup and Measurement

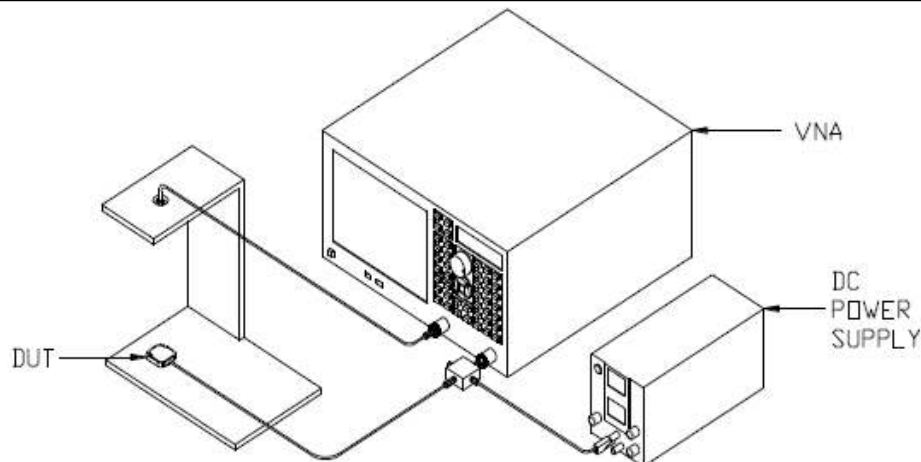

ATTENTION: Abracon LLC's products are COTS – Commercial-Off-The-Shelf products; suitable for Commercial, Industrial and, where designated, Automotive Applications. Abracon's products are not specifically designed for Military, Aviation, Aerospace, Life-dependent Medical applications or any application requiring high reliability where component failure could result in loss of life and/or property. For applications requiring high reliability and/or presenting an extreme operating environment, written consent and authorization from Abracon LLC is required. Please contact Abracon LLC for more information.



5101 Hidden Creek Ln Spicewood TX 78669
Phone: 512-371-6159 | Fax: 512-351-8858
For terms and conditions of sales, please visit:
www.abracon.com

REVISED: 11.12.2018

ABRACON IS
ISO9001-2015
CERTIFIED