

| ITEM | Q'TY | PART NUMBER | PART DESCRIPTION |
|------|------|-------------|-----------------------------------|
| 1 | 1 | MPC3 | Chrome Panel Mount Holder, 3mm |
| 2 | 1 | 3XX-F | T-1 (3mm) Flanged LED |
| 3 | 1 | BWS24AWG-RD | 24AWG Wire Lead, U.L. 1007, Red |
| 4 | 1 | BWS24AWG-BK | 24AWG Wire Lead, U.L. 1007, Black |
| 5 | 2 | BST200-BK | Shrink Tubing, 0.500" Black |

| REV. | DESCRIPTION | DATE | APPROVED |
|------|---------------------------------------|----------|----------|
| A | Engineering Release. | 07/27/07 | M. C. |
| B | Updated 3UWC-0.6K-F with 3UWC1.035C-F | 04/26/12 | T. Y. |
| C | Updated LED offering | 05/03/12 | T. Y. |
| D | Updated Bi-Color Polarity Table | 12/18/12 | T. Y. |
| E | Edit Part Number on Page 2 | 11/11/13 | G. W. |
| F | Updated LED Optical Characteristics | 09/14/15 | J. C. |

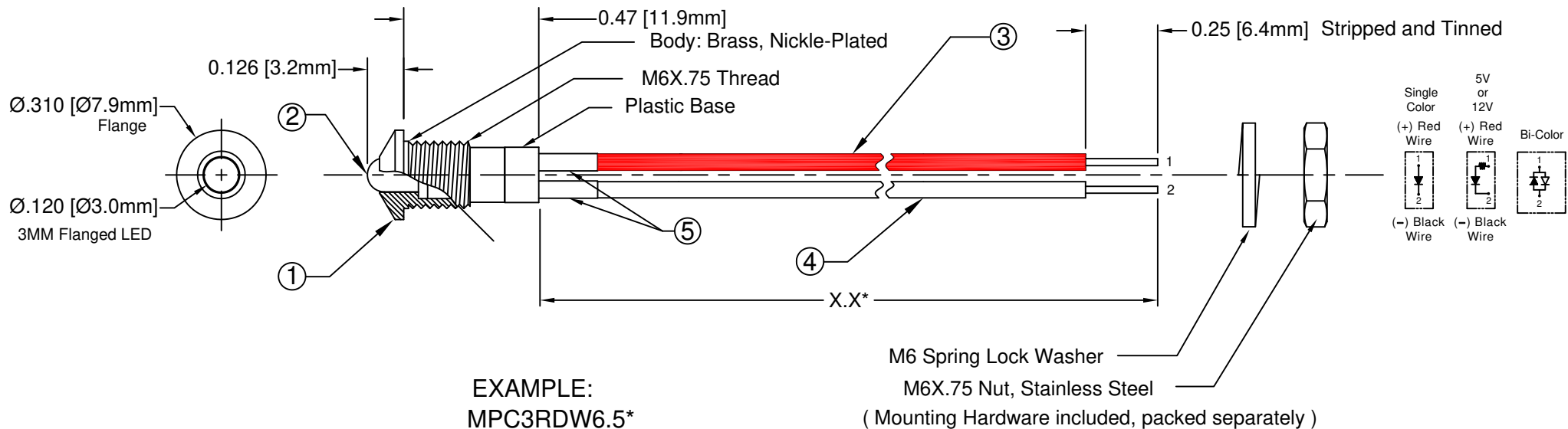

EXAMPLE:
MPC3RDW6.5*

Series
LED Color, Lens Appearance
Wire Length in inches

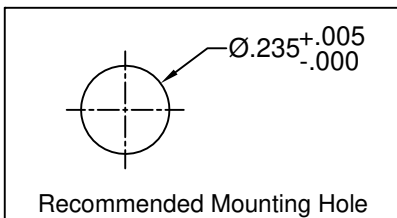

| BI-COLOR POLARITY | | |
|-------------------|-------------|-------------|
| LED P/N | (1) Cathode | (2) Cathode |
| 3BC-F | Green | Red |
| 3BC-Y/G-F | Green | Yellow |
| 3BC-R/Y-F | Yellow | Red |
| 3BC-A/G-F | Green | Amber |



ABSOLUTE MAXIMUM RATINGS (Ta = 25°C)

| | |
|--|---------------------|
| REVERSE VOLTAGE | 5V |
| REVERSE CURRENT (VR=5V) | 100µA |
| OPERATING TEMPERATURE RANGE | -40°C ~ 85°C |
| STORAGE TEMPERATURE | -40°C ~ 100°C |
| LEAD SOLDERING TEMPERATURE (1/16" FROM BODY) | 260°C for 5 Seconds |

| STANDARD TOLERANCE (UNLESS OTHERWISE SPECIFIED) | | BIVAR® | |
|--|--------------------------|---|--|
| DECIMALS | ANGULAR | 4 THOMAS, IRVINE, CA. 92618 | |
| .X ± .1 | X° ± 1° | TEL: (949) 951-8808 FAX: (949) 951-3974 | |
| .XX ± .02 | | TITLE: STD METAL PANEL MOUNT INDICATORS W/ WIRES | |
| .XXX ± .010 | | PART NO: MPC3XXWX.X | |
| DESIGNED: Dan Beckman | DATE: 07/27/07 | REVISION: F | |
| CHECKED: T. Yin | DATE: 07/27/07 | CAGE CODE : 32559 SHEET # 1 OF 4 | |
| CAD GENERATED DOCUMENT. DO NOT MEASURE DRAWING. | | | |



| | | | |
|------|---------------|------|----------|
| REV. | DESCRIPTION | DATE | APPROVED |
| | SEE SHEET #1. | | |

| LED Assy. No. | Chip | | | Lens Appearance | Electro-Optical Data @ 20mA | | | | Viewing Angle 2 θ ½ (Deg) | LED P/N |
|----------------|-----------|------------------|---------------|-----------------|-----------------------------|--------|-----|----------|---------------------------------|-----------|
| | Material | Peak Wave Length | Emitted Color | | If (mA) | Vf (V) | | Iv (mcd) | | |
| | | | | | | MAX | TYP | MAX | TYP | |
| MPC3BWCWX.X | GaN/SiC | 430 | BLUE | WATER CLEAR | 25 | 4 | 4.5 | 15 | 20 | 3BWC-F |
| MPC3BWDWX.X | GaN/SiC | 430 | BLUE | DIFFUSED | 25 | 4 | 4.5 | 10 | 35 | 3BWD-F |
| MPC3BWTWX.X | GaN/SiC | 430 | BLUE | TINTED | 25 | 4 | 4.5 | 15 | 20 | 3BWT-F |
| MPC3GCWX.X | GaP/GaP | 568 | GREEN | WATER CLEAR | 30 | 2.1 | 2.8 | 40 | 20 | 3GC-F |
| MPC3GDWX.X | GaP/GaP | 568 | GREEN | DIFFUSED | 30 | 2.1 | 2.8 | 25 | 35 | 3GD-F |
| MPC3GTWX.X | GaP/GaP | 568 | GREEN | TINTED | 30 | 2.1 | 2.8 | 40 | 20 | 3GT-F |
| MPC3PGCWX.X | GaP/GaP | 555 | PURE GREEN | WATER CLEAR | 30 | 2.2 | 2.8 | 10 | 20 | 3PGC-F |
| MPC3PGDWX.X | GaP/GaP | 555 | PURE GREEN | DIFFUSED | 30 | 2.2 | 2.8 | 5 | 35 | 3PGD-F |
| MPC3PGTWX.X | GaP/GaP | 555 | PURE GREEN | TINTED | 30 | 2.2 | 2.8 | 10 | 20 | 3PGT-F |
| MPC3YCWX.X | GaAsP/GaP | 590 | YELLOW | WATER CLEAR | 30 | 2 | 2.8 | 40 | 20 | 3YC-F |
| MPC3YDWX.X | GaAsP/GaP | 590 | YELLOW | DIFFUSED | 30 | 2 | 2.8 | 20 | 35 | 3YD-F |
| MPC3YTWX.X | GaAsP/GaP | 590 | YELLOW | TINTED | 30 | 2 | 2.8 | 40 | 20 | 3YT-F |
| MPC3ACWX.X | GaAsP/GaP | 605 | AMBER | WATER CLEAR | 30 | 2 | 2.8 | 40 | 20 | 3AC-F |
| MPC3ADWX.X | GaAsP/GaP | 605 | AMBER | DIFFUSED | 30 | 2 | 2.8 | 25 | 35 | 3AD-F |
| MPC3ATWX.X | GaAsP/GaP | 605 | AMBER | TINTED | 30 | 2 | 2.8 | 40 | 20 | 3AT-F |
| MPC3HCWX.X | GaAsP/GaP | 625 | HE RED | WATER CLEAR | 30 | 2 | 2.8 | 50 | 20 | 3HC-F |
| MPC3HDWX.X | GaAsP/GaP | 625 | HE RED | DIFFUSED | 30 | 2 | 2.8 | 30 | 35 | 3HD-F |
| MPC3HTWX.X | GaAsP/GaP | 625 | HE RED | TINTED | 30 | 2 | 2.8 | 50 | 20 | 3HT-F |
| MPC3RCWX.X | GaP/GaP | 700 | RED | WATER CLEAR | 20 | 2.1 | 2.8 | 2.5 | 35 | 3RC-F |
| MPC3RDWX.X | GaP/GaP | 700 | RED | DIFFUSED | 20 | 2.1 | 2.8 | 2 | 20 | 3RD-F |
| MPC3RTWX.X | GaP/GaP | 700 | RED | TINTED | 20 | 2.1 | 2.8 | 2.5 | 20 | 3RT-F |
| MPC3BCWX.X-A/G | GaAsP/GaP | 605 | AMBER | DIFFUSED | 30 | 2.0 | 2.8 | 6 | 45 | 3BC-A/G-F |
| | GaP/GaP | 568 | GREEN | | 30 | 2.1 | 2.8 | 6 | | |
| MPC3BCWX.X | GaAsP/GaP | 625 | RED | DIFFUSED | 30 | 2.0 | 2.8 | 6 | 45 | 3BC-F |
| | GaP/GaP | 568 | GREEN | | 30 | 2.1 | 2.8 | 6 | | |
| MPC3BCWX.X-R/Y | GaAsP/GaP | 625 | RED | DIFFUSED | 30 | 2.0 | 2.8 | 6 | 45 | 3BC-R/Y-F |
| | GaAsP/GaP | 590 | YELLOW | | 30 | 2.0 | 2.8 | 4 | | |
| MPC3BCWX.X-Y/G | GaAsP/GaP | 590 | YELLOW | DIFFUSED | 30 | 2.0 | 2.8 | 4 | 45 | 3BC-Y/G-F |
| | GaP/GaP | 568 | GREEN | | 30 | 2.1 | 2.8 | 6 | | |

| | | | |
|---|--------------------------|--|-----------------------|
| STANDARD TOLERANCE (UNLESS OTHERWISE SPECIFIED) ±10% ALL VALUES ANGULAR X° ± 5° | |  4 THOMAS, IRVINE, CA. 92618 TEL: (949) 951-8808 FAX: (949) 951-3974 | |
|  | | | |
| DESIGNED: Dan Beckman | DATE: 07/27/07 | TITLE: STD METAL PANEL MOUNT INDICATORS W/ WIRES | |
| CHECKED: T. Yin | DATE: 07/27/07 | PART NO: MPC3XXWX.X | REVISION: F |
| | | CAGE CODE : 32559 | SHEET # 2 OF 4 |
| CAD GENERATED DOCUMENT. DO NOT MEASURE DRAWING. | | | |

| | | | |
|------|---------------|------|----------|
| REV. | DESCRIPTION | DATE | APPROVED |
| | SEE SHEET #1. | | |

| LED Assy. No. | Chip | | | Lens Appearance | Electro-Optical Data @ 20mA | | | | Viewing Angle 2 θ ½ (Deg) | LED P/N |
|---------------|----------------|------------------|---------------|-----------------|-----------------------------|--------|-----|----------|---------------------------|--------------|
| | Material | Peak Wave Length | Emitted Color | | If (mA) | Vf (V) | | Iv (mcd) | | |
| | | | | | MAX | TYP | MAX | TYP | | |
| MPC3UBWCWX.X | GaN/SiC | 470 | BLUE | WATER CLEAR | 30 | 4 | 4.5 | 400 | 30 | 3UBWC-0.6K-F |
| MPC3SGCWX.X | GaP/GaP | 568 | GREEN | WATER CLEAR | 30 | 2.1 | 2.8 | 50 | 20 | 3SGC-F |
| MPC3SGDWX.X | GaP/GaP | 568 | GREEN | DIFFUSED | 30 | 2.1 | 2.8 | 30 | 35 | 3SGD-F |
| MPC3SGTWX.X | GaP/GaP | 568 | GREEN | TINTED | 30 | 2.1 | 2.8 | 50 | 20 | 3SGT-F |
| MPC3SYCWX.X | GaAsP/GaP | 590 | YELLOW | WATER CLEAR | 30 | 2.0 | 2.8 | 50 | 20 | 3SYC-F |
| MPC3SYDWX.X | GaAsP/GaP | 590 | YELLOW | DIFFUSED | 30 | 2.0 | 2.8 | 30 | 35 | 3SYD-F |
| MPC3SYTWX.X | GaAsP/GaP | 590 | YELLOW | TINTED | 30 | 2.0 | 2.8 | 50 | 20 | 3SYT-F |
| MPC3SACWX.X | AlGaInP | 605 | AMBER | WATER CLEAR | 30 | 1.8 | 2.4 | 300 | 20 | 3SAC-F |
| MPC3SADWX.X | AlGaInP | 605 | AMBER | DIFFUSED | 30 | 1.8 | 2.4 | 100 | 35 | 3SAD-F |
| MPC3SATWX.X | AlGaInP | 605 | AMBER | TINTED | 30 | 1.8 | 2.4 | 300 | 20 | 3SAT-F |
| MPC3SRCWX.X | GaAlAs/GaAs | 645 | SUPER RED | WATER CLEAR | 30 | 1.7 | 2.4 | 60 | 20 | 3SRC-F |
| MPC3SRDWX.X | GaAlAs/GaAs | 645 | SUPER RED | DIFFUSED | 30 | 1.7 | 2.4 | 40 | 35 | 3SRD-F |
| MPC3SRTWX.X | GaAlAs/GaAs | 645 | SUPER RED | TINTED | 30 | 1.7 | 2.4 | 60 | 20 | 3SRT-F |
| MPC3UGCWX.X | AlGaInP | 570 | GREEN | WATER CLEAR | 30 | 2.1 | 2.4 | 200 | 20 | 3UGC-F |
| MPC3SUGCWX.X | AlGaInP | 570 | GREEN | WATER CLEAR | 30 | 2.1 | 2.4 | 300 | 35 | 3SUGC-F |
| MPC3UYCWX.X | AlGaInP | 590 | YELLOW | WATER CLEAR | 30 | 2.0 | 2.4 | 300 | 20 | 3UYC-F |
| MPC3SUYCWX.X | AlGaInP | 590 | YELLOW | WATER CLEAR | 30 | 2.0 | 2.4 | 400 | 20 | 3SUYC-F |
| MPC3UUYCWX.X | AlGaInP | 590 | YELLOW | WATER CLEAR | 30 | 2.0 | 2.4 | 600 | 35 | 3UUYC-F |
| MPC3UOCWX.X | AlGaInP | 625 | ORANGE | WATER CLEAR | 30 | 1.8 | 2.4 | 300 | 20 | 3UOC-F |
| MPC3SUOCWX.X | AlGaInP | 625 | ORANGE | WATER CLEAR | 30 | 1.8 | 2.4 | 400 | 20 | 3SUOC-F |
| MPC3URCWX.X | GaAlAs/GaAs | 645 | RED | WATER CLEAR | 30 | 1.7 | 2.4 | 200 | 35 | 3URC-F |
| MPC3SURCWX.X | AlGaInP | 640 | RED | WATER CLEAR | 30 | 1.8 | 2.4 | 200 | 20 | 3SURC-F |
| MPC3UWCWX.X | InGaN/Sapphire | 6500K | WHITE | WATER CLEAR | 30 | 3.2 | 3.6 | 6000 | 35 | 3UWC1.035C-F |

| | | | |
|---|--|---|--|
| STANDARD TOLERANCE (UNLESS OTHERWISE SPECIFIED) ±10% ALL VALUES | |  4 THOMAS, IRVINE, CA. 92618 TEL: (949) 951-8808 FAX: (949) 951-3974 | |
| ANGULAR X° ± 5° | |  | |
| DESIGNED: Dan Beckman | | DATE: 07/27/07 | |
| CHECKED: T. Yin | | DATE: 07/27/07 | |
| TITLE: STD METAL PANEL MOUNT INDICATORS W/ WIRES | | PART NO: MPC3XXWX.X | |
| REVISION: F | | CAGE CODE : 32559 SHEET # 3 OF 4 CAD GENERATED DOCUMENT. DO NOT MEASURE DRAWING. | |

| | | | |
|------|---------------|------|----------|
| REV. | DESCRIPTION | DATE | APPROVED |
| | SEE SHEET #1. | | |

| LED Assy. No. | Chip | | | Lens Appearance | Absolute Max. Ratings | | | Electro-Optical Data @ 2mA | | | Viewing Angle 2 θ ½ (Deg) | LED P/N |
|---------------|-------------|----------------------------|---------------|-----------------|-----------------------|------------|----------------|----------------------------|-----|-------------|---------------------------------|---------|
| | Material | Peak Wave Length λp(nm) | Emitted Color | | Pd (mW) | If (mA) | Peak If(mA) | Vf (V) | | Iv (mcd) | | |
| | | | | | | | | TYP | MAX | TYP | | |
| MPC3BVDLWX.X | GaN/siC | 430 | BLUE | DIFFUSED | 20 | 7 | - | 3.8 | 4.2 | 2.5 | 35 | 3BVDL-F |
| MPC3GDLWX.X | GaP/GaP | 568 | GREEN | DIFFUSED | 10 | 7 | - | 2.1 | 2.6 | 4.0 | 35 | 3GDL-F |
| MPC3PGDLWX.X | GaP/GaP | 555 | PURE GREEN | DIFFUSED | 10 | 7 | - | 2.1 | 2.6 | 0.2 | 35 | 3PGDL-F |
| MPC3YDLWX.X | GaAsP/GaP | 590 | YELLOW | DIFFUSED | 10 | 7 | - | 2.0 | 2.6 | 2.0 | 35 | 3YDL-F |
| MPC3ADLWX.X | GaAsP/GaP | 605 | AMBER | DIFFUSED | 10 | 7 | - | 2.0 | 2.6 | 4.0 | 35 | 3ADL-F |
| MPC3HDLWX.X | GaAsP/GaP | 625 | RED | DIFFUSED | 10 | 7 | - | 2.0 | 2.6 | 2.5 | 35 | 3HDL-F |
| MPC3RDLWX.X | GaP/GaP | 700 | RED | DIFFUSED | 10 | 7 | - | 2.1 | 2.6 | 0.5 | 35 | 3RDL-F |
| MPC3SRDLWX.X | GaAlAs/GaAs | 645 | RED | DIFFUSED | 10 | 7 | - | 2.0 | - | 8.0 | 35 | 3SRDL-F |

| LED Assy. No. | Peak Wave Length λp(nm) | Emitted Color | Lens Appearance | Electro-Optical Data | | | | Viewing Angle 2 θ ½ (Deg) | LED P/N |
|----------------|----------------------------|---------------|-----------------|----------------------|-----------|-----|-------------|---------------------------------|----------|
| | | | | If (mA) | Vf (V) | | Iv (mcd) | | |
| | | | | | MAX | TYP | | | |
| 5 Volt | | | | Data @ 5V | | | | | |
| MPC3BWD5VWX.X | 430 | BLUE | DIFFUSED | - | - | 5 | 10 | 35 | 3BWD5V-F |
| MPC3GC5VWX.X | 568 | GREEN | WATER CLEAR | - | - | 5 | 40 | 20 | 3GC5V-F |
| MPC3GD5VWX.X | 568 | GREEN | DIFFUSED | - | - | 5 | 25 | 35 | 3GD5V-F |
| MPC3GT5VWX.X | 568 | GREEN | TINTED | - | - | 5 | 40 | 20 | 3GT5V-F |
| MPC3AD5VWX.X | 605 | AMBER | DIFFUSED | - | - | 5 | 25 | 35 | 3AD5V-F |
| MPC3HD5VWX.X | 625 | HE RED | DIFFUSED | - | - | 5 | 30 | 35 | 3HD5V-F |
| MPC3RD5VWX.X | 700 | RED | DIFFUSED | - | - | 5 | 2 | 35 | 3RD5V-F |
| MPC3YD5VWX.X | 590 | YELLOW | DIFFUSED | - | - | 5 | 20 | 35 | 3YD5V-F |
| 12 Volt | | | | Data @ 12V | | | | | |
| MPC3GC12VWX.X | 568 | GREEN | WATER CLEAR | - | - | 12 | 40 | 20 | 3GC12V-F |
| MPC3GD12VWX.X | 568 | GREEN | DIFFUSED | - | - | 12 | 25 | 35 | 3GD12V-F |
| MPC3HC12VWX.X | 625 | RED | WATER CLEAR | - | - | 12 | 50 | 20 | 3HC12V-F |
| MPC3HD12VWX.X | 625 | RED | DIFFUSED | - | - | 12 | 30 | 35 | 3HD12V-F |
| MPC3RC12VWX.X | 700 | RED | WATER CLEAR | - | - | 12 | 6 | 20 | 3RC12V-F |
| MPC3RD12VWX.X | 700 | RED | DIFFUSED | - | - | 12 | 2 | 35 | 3RD12V-F |
| MPC3YC12VWX.X | 590 | YELLOW | WATER CLEAR | - | - | 12 | 40 | 20 | 3YC12V-F |
| MPC3YD12VWX.X | 590 | YELLOW | DIFFUSED | - | - | 12 | 25 | 35 | 3YD12V-F |

| | | | | |
|---|--|--------------------------|--|---|
| STANDARD TOLERANCE (UNLESS OTHERWISE SPECIFIED) ±10% ALL VALUES | | ANGULAR X° ± 5° | |  BIVAR [®] 4 THOMAS, IRVINE, CA. 92618 TEL: (949) 951-8808 FAX: (949) 951-3974 |
| DESIGNED: Dan Beckman | | DATE: 07/27/07 | | |
| CHECKED: T. Yin | | DATE: 07/27/07 | | TITLE: STD METAL PANEL MOUNT INDICATORS W/ WIRES PART NO: MPC3XXWX.X CAGE CODE : 32559 SHEET # 4 OF 4 REVISION: F <small>CAD GENERATED DOCUMENT. DO NOT MEASURE DRAWING.</small> |