

**4.3A, 1000V, 3.500 Ohm, High Voltage, N-Channel Power MOSFETs**

The RFP4N100 and RFP4N100SM are N-Channel enhancement mode silicon gate power field effect transistors. They are designed for use in applications such as switching regulators, switching converters, motor drivers, relay drivers, and drivers for high power bipolar switching transistors requiring high speed and low gate drive power. This type can be operated directly from an integrated circuit.

Formerly developmental type TA09850.

**Ordering Information**

PART NUMBER	PACKAGE	BRAND
RFP4N100	TO-220AB	RFP4N100
RF1S4N100SM	TO-263AB	F1S4N100

NOTE: When ordering, use the entire part number.

**Features**

- 4.3A, 1000V
- $r_{DS(ON)} = 3.500\Omega$
- UIS Rating Curve (Single Pulse)
- -55°C to 150°C Operating Temperature
- Related Literature
  - TB334 "Guidelines for Soldering Surface Mount Components to PC Boards"

**Symbol**

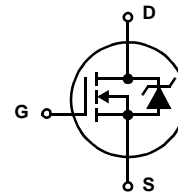

**Packaging**

JEDEC TO-220AB

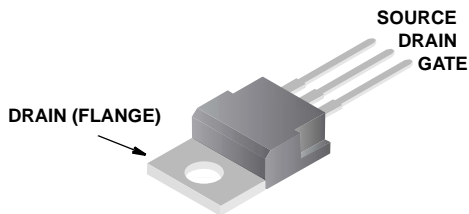

JEDEC TO-263AB

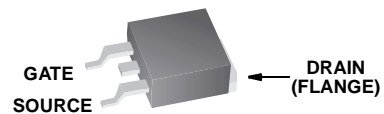

# RFP4N100, RF1S4N100SM

## Absolute Maximum Ratings $T_C = 25^\circ\text{C}$ , Unless Otherwise Specified

	RFP4N100, RF1S4N100SM	UNITS
Drain to Source Breakdown Voltage (Note 1) . . . . .	1000	V
Drain to Gate Voltage ( $R_{GS} = 20k\Omega$ ) (Note 1) . . . . .	1000	V
Continuous Drain Current . . . . .	4.3	A
Pulsed Drain Current (Note 3) . . . . .	17	A
Gate to Source Voltage . . . . .	$\pm 20$	V
Single Pulse Avalanche Rating . . . . .	(See UIS SOA Curve) (Figures 4, 14, 15)	mJ
Maximum Power Dissipation . . . . .	150	W
Linear Derating Factor . . . . .	1.2	W/ $^\circ\text{C}$
Operating and Storage Temperature . . . . .	-55 to 150	$^\circ\text{C}$
Maximum Temperature for Soldering		
Leads at 0.063in (1.6mm) from case for 10s . . . . .	300	$^\circ\text{C}$
Package Body for 10s, see Techbrief 334 . . . . .	260	$^\circ\text{C}$

*CAUTION: Stresses above those listed in "Absolute Maximum Ratings" may cause permanent damage to the device. This is a stress only rating and operation of the device at these or any other conditions above those indicated in the operational sections of this specification is not implied.*

**NOTE:**

1.  $T_J = 25^\circ\text{C}$  to  $125^\circ\text{C}$ .

## Electrical Specifications $T_C = 25^\circ\text{C}$ , Unless Otherwise Specified

PARAMETER	SYMBOL	TEST CONDITIONS	MIN	TYP	MAX	UNITS
Drain to Source Breakdown Voltage	$BV_{DSS}$	$I_D = 250\mu\text{A}$ , $V_{GS} = 0\text{V}$ (Figure 10)	1000	-	-	V
Gate Threshold Voltage	$V_{GS(TH)}$	$V_{GS} = V_{DS}$ , $I_D = 250\mu\text{A}$	2	-	4	V
Zero Gate Voltage Drain Current	$I_{DSS}$	$V_{DS} = 1000\text{V}$ , $V_{GS} = 0\text{V}$	-	-	25	$\mu\text{A}$
		$V_{DS} = 800\text{V}$ , $V_{GS} = 0\text{V}$ , $T_C = 150^\circ\text{C}$	-	-	100	$\mu\text{A}$
Gate to Source Leakage Current	$I_{GSS}$	$V_{GS} = \pm 20\text{V}$	-	-	$\pm 100$	nA
Drain to Source On Resistance (Note 2)	$r_{DS(ON)}$	$I_D = 2.5\text{A}$ , $V_{GS} = 10\text{V}$ (Figures 8, 9)	-	-	3.500	$\Omega$
Turn-On Delay Time	$t_{d(ON)}$	$V_{DD} = 500\text{V}$ , $I_D \approx 3.9\text{A}$ , $R_{GS} = 9.1\Omega$ , $R_L = 120\Omega$	-	-	30	ns
Rise Time	$t_r$		-	-	50	ns
Turn-Off Delay Time	$t_{d(OFF)}$		-	-	170	ns
Fall Time	$t_f$		-	-	50	ns
Total Gate Charge (Gate to Source + Gate to Drain)	$Q_{g(TOT)}$	$V_{GS} = 20\text{V}$ , $I_D = 3.9\text{A}$ , $V_{DS} = 800\text{V}$ (Figure 13)	-	-	120	nC
Thermal Resistance Junction to Case	$R_{\theta JC}$		-	-	0.83	$^\circ\text{C/W}$
Thermal Resistance Junction to Ambient	$R_{\theta JA}$		-	-	62	$^\circ\text{C/W}$

## Source to Drain Diode Specifications

PARAMETER	SYMBOL	TEST CONDITIONS	MIN	TYP	MAX	UNITS
Source to Drain Diode Voltage	$V_{SD}$	$I_{SD} = 4.3\text{A}$	-	-	1.8	V
Reverse Recovery Time	$t_{rr}$	$I_{SD} = 3.9\text{A}$ , $dI_{SD}/dt = 100\text{A}/\mu\text{s}$	-	-	1000	ns

**NOTES:**

2. Pulse test: pulse width  $\leq 80\mu\text{s}$ , duty cycle  $\leq 2\%$ .
3. Repetitive rating: pulse width limited by maximum junction temperature.

Typical Performance Curves  $T_C = 25^\circ\text{C}$ , Unless Otherwise Specified

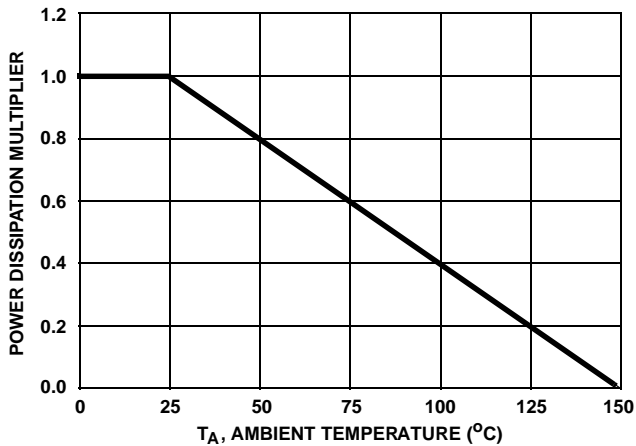

FIGURE 1. NORMALIZED POWER DISSIPATION vs AMBIENT TEMPERATURE

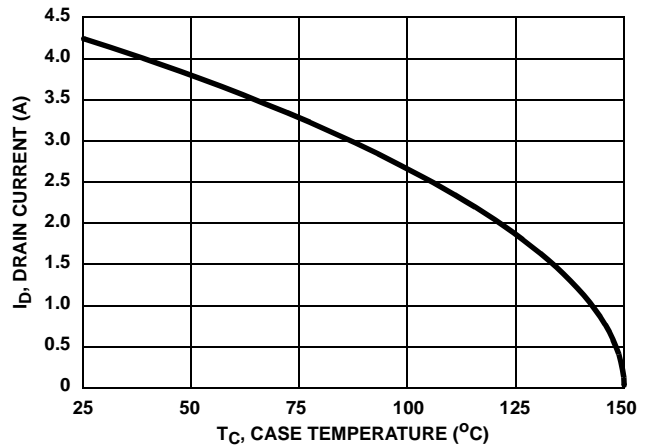

FIGURE 2. MAXIMUM CONTINUOUS DRAIN CURRENT vs CASE TEMPERATURE

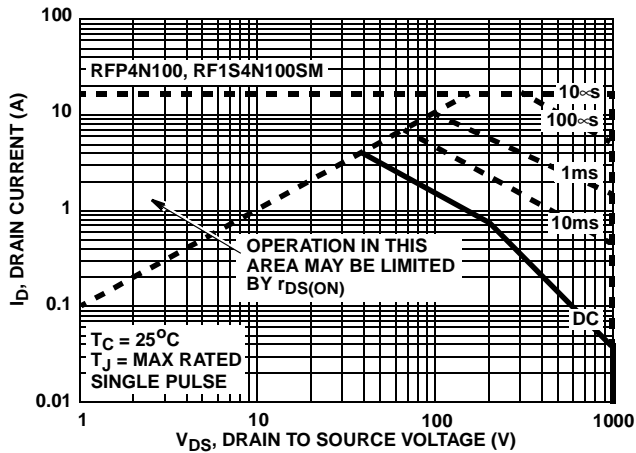

FIGURE 3. FORWARD BIAS SAFE OPERATING AREA

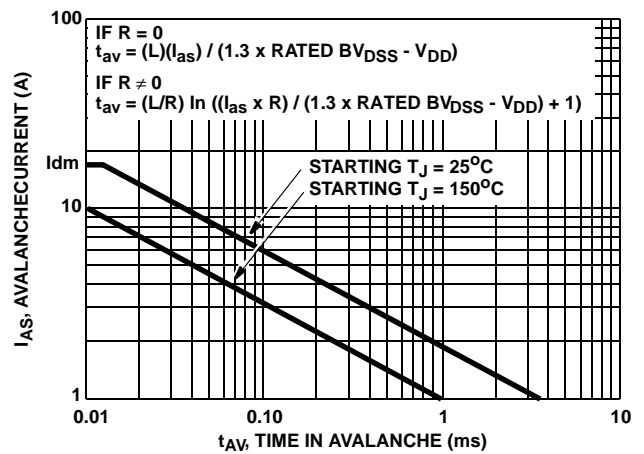

FIGURE 4. UNCLAMPED INDUCTIVE SWITCHING SOA

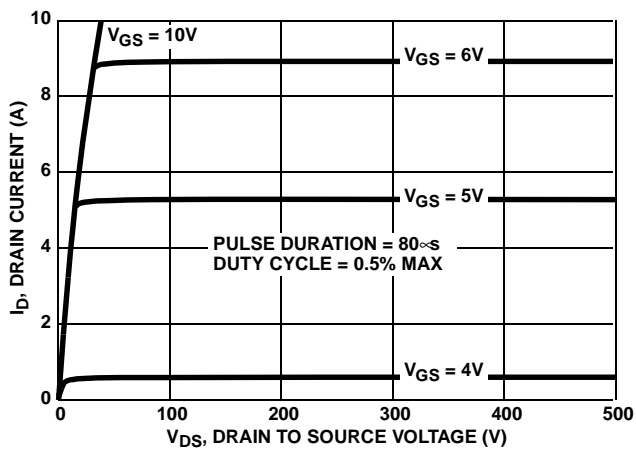

FIGURE 5. OUTPUT CHARACTERISTICS

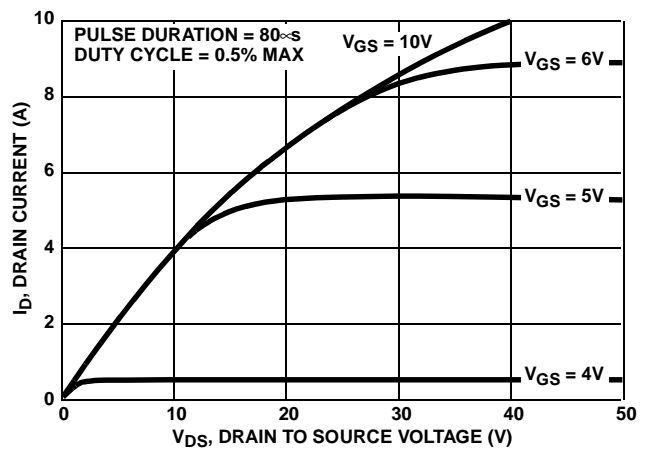

FIGURE 6. SATURATION CHARACTERISTICS

Typical Performance Curves  $T_C = 25^\circ\text{C}$ , Unless Otherwise Specified (Continued)

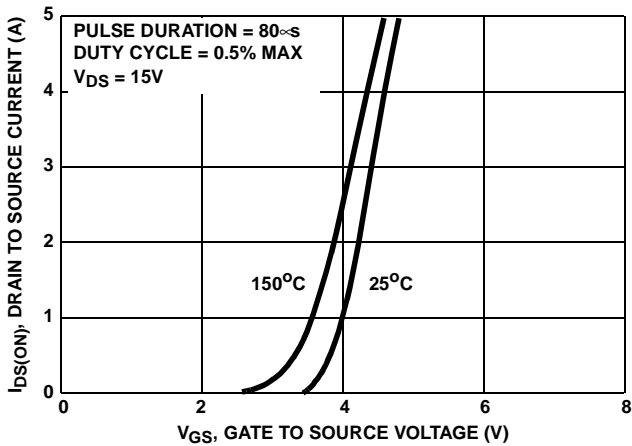

FIGURE 7. TRANSFER CHARACTERISTICS

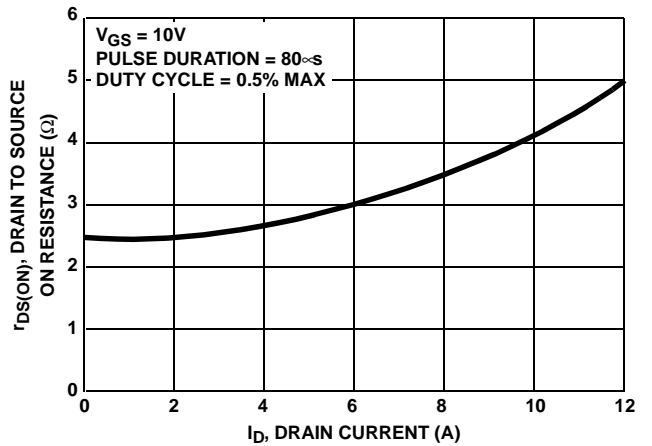

FIGURE 8. DRAIN TO SOURCE ON RESISTANCE vs DRAIN CURRENT

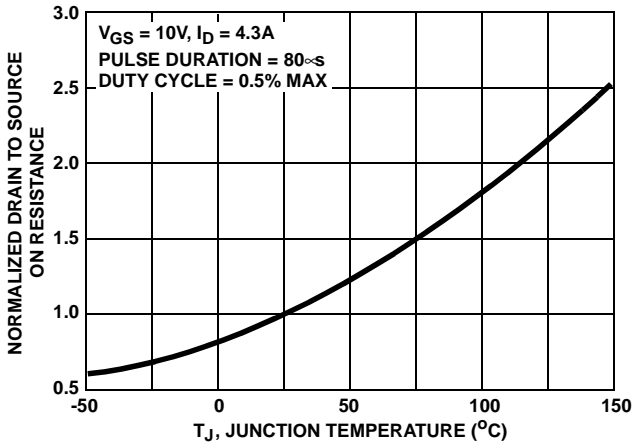

FIGURE 9. NORMALIZED DRAIN TO SOURCE ON RESISTANCE vs JUNCTION TEMPERATURE

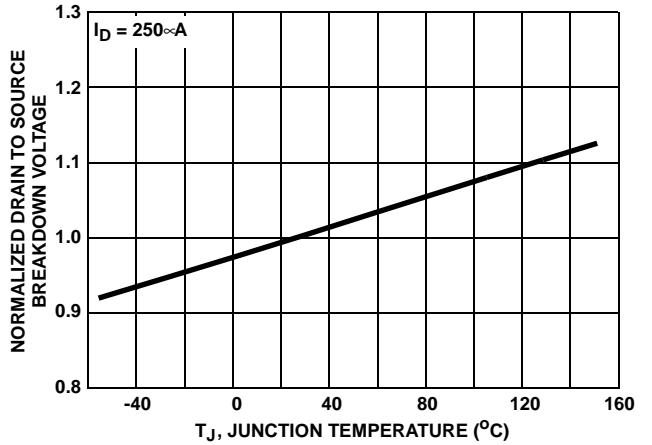

FIGURE 10. NORMALIZED DRAIN TO SOURCE BREAKDOWN VOLTAGE vs JUNCTION TEMPERATURE

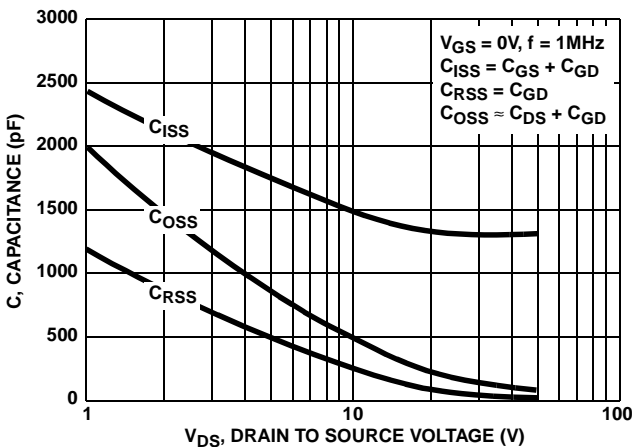

FIGURE 11. CAPACITANCE vs DRAIN TO SOURCE VOLTAGE

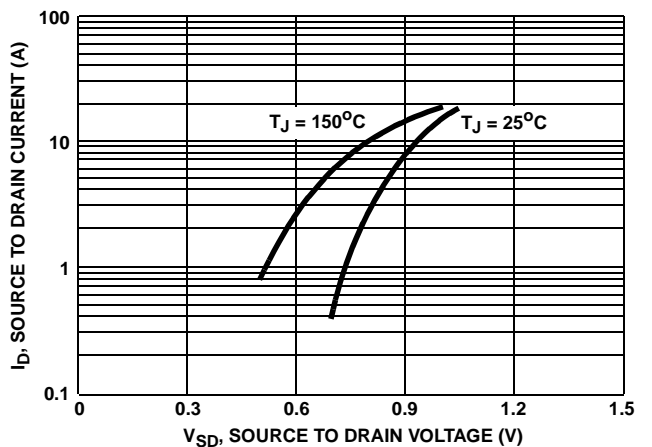

FIGURE 12. DRAIN CURRENT vs SOURCE TO DRAIN DIODE VOLTAGE

Typical Performance Curves  $T_C = 25^\circ\text{C}$ , Unless Otherwise Specified (Continued)

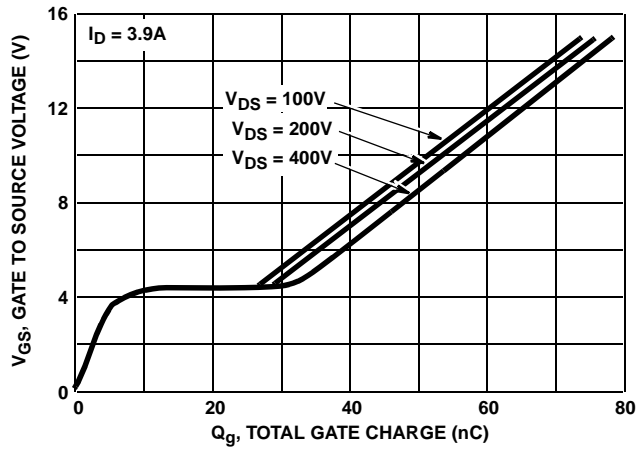

FIGURE 13. GATE TO SOURCE VOLTAGE vs GATE CHARGE

Test Circuits and Waveforms

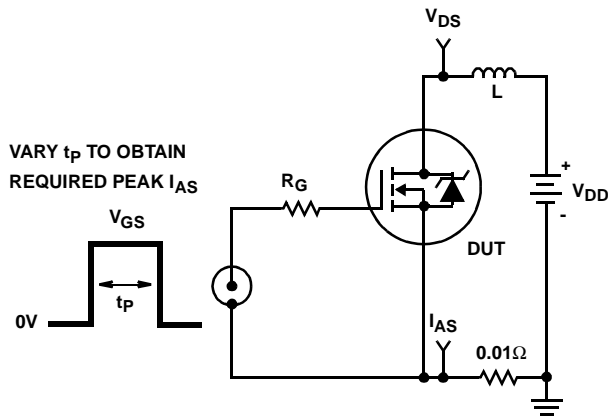

FIGURE 14. UNCLAMPED ENERGY TEST CIRCUIT

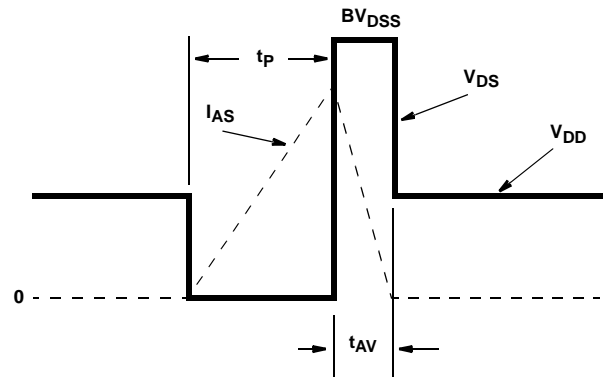

FIGURE 15. UNCLAMPED ENERGY WAVEFORMS

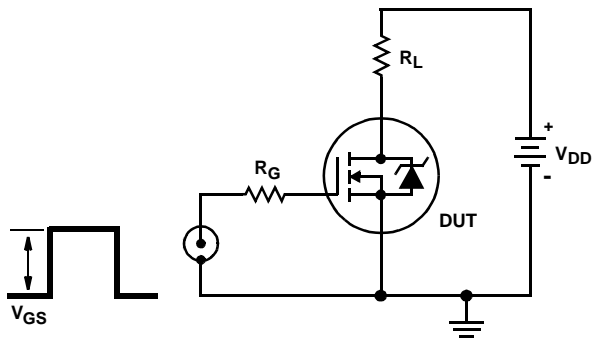

FIGURE 16. SWITCHING TIME TEST CIRCUIT

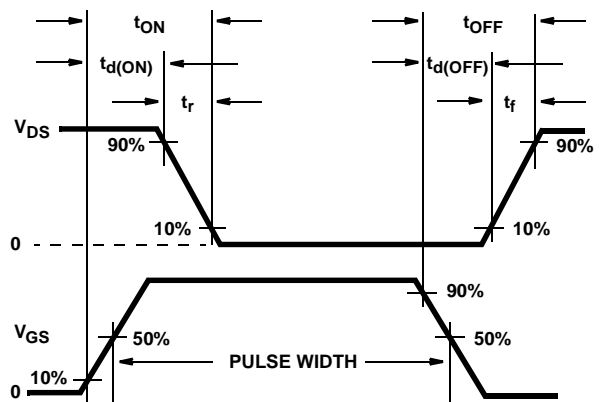

FIGURE 17. RESISTIVE SWITCHING WAVEFORMS

Test Circuits and Waveforms (Continued)

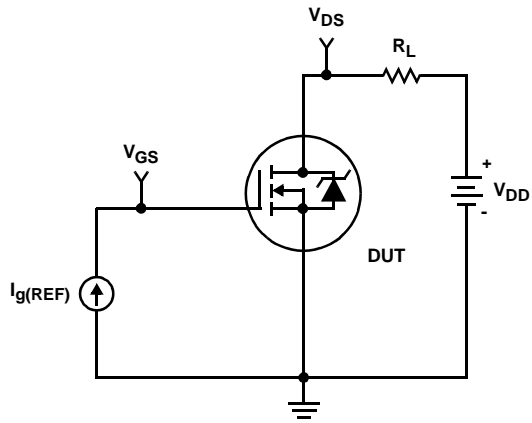

FIGURE 18. GATE CHARGE TEST CIRCUIT

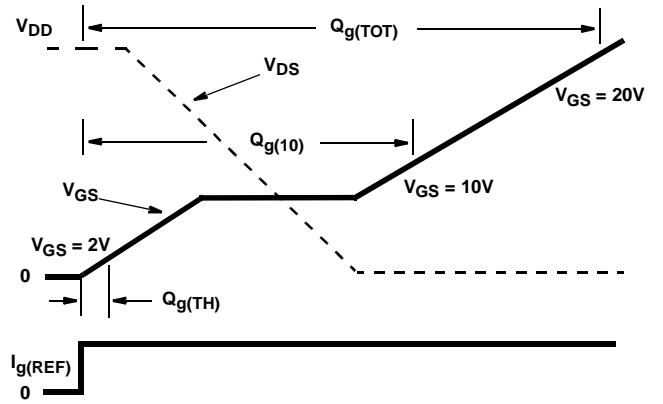

FIGURE 19. GATE CHARGE WAVEFORMS

## TRADEMARKS

The following are registered and unregistered trademarks Fairchild Semiconductor owns or is authorized to use and is not intended to be an exhaustive list of all such trademarks.

ACE <sub>x</sub> <sup>™</sup>	FAST <sup>®</sup>	OPTOLOGIC <sup>™</sup>	SMART START <sup>™</sup>	VCX <sup>™</sup>
Bottomless <sup>™</sup>	FAST <sub>r</sub> <sup>™</sup>	OPTOPLANAR <sup>™</sup>	STAR*POWER <sup>™</sup>	
CoolFET <sup>™</sup>	FRFET <sup>™</sup>	PACMAN <sup>™</sup>	Stealth <sup>™</sup>	
CROSSVOLT <sup>™</sup>	GlobalOptoisolator <sup>™</sup>	POP <sup>™</sup>	SuperSOT <sup>™</sup> -3	
DenseTrench <sup>™</sup>	GTO <sup>™</sup>	Power247 <sup>™</sup>	SuperSOT <sup>™</sup> -6	
DOMET <sup>™</sup>	HiSeC <sup>™</sup>	PowerTrench <sup>®</sup>	SuperSOT <sup>™</sup> -8	
EcoSPARK <sup>™</sup>	ISOPLANAR <sup>™</sup>	QFET <sup>™</sup>	SyncFET <sup>™</sup>	
E <sup>2</sup> CMOS <sup>™</sup>	LittleFET <sup>™</sup>	QS <sup>™</sup>	TinyLogic <sup>™</sup>	
EnSigna <sup>™</sup>	MicroFET <sup>™</sup>	QT Optoelectronics <sup>™</sup>	TruTranslation <sup>™</sup>	
FACT <sup>™</sup>	MicroPak <sup>™</sup>	Quiet Series <sup>™</sup>	UHC <sup>™</sup>	
FACT Quiet Series <sup>™</sup>	MICROWIRE <sup>™</sup>	SILENT SWITCHER <sup>®</sup>	UltraFET <sup>®</sup>	

STAR\*POWER is used under license

## DISCLAIMER

FAIRCHILD SEMICONDUCTOR RESERVES THE RIGHT TO MAKE CHANGES WITHOUT FURTHER NOTICE TO ANY PRODUCTS HEREIN TO IMPROVE RELIABILITY, FUNCTION OR DESIGN. FAIRCHILD DOES NOT ASSUME ANY LIABILITY ARISING OUT OF THE APPLICATION OR USE OF ANY PRODUCT OR CIRCUIT DESCRIBED HEREIN; NEITHER DOES IT CONVEY ANY LICENSE UNDER ITS PATENT RIGHTS, NOR THE RIGHTS OF OTHERS.

## LIFE SUPPORT POLICY

FAIRCHILD'S PRODUCTS ARE NOT AUTHORIZED FOR USE AS CRITICAL COMPONENTS IN LIFE SUPPORT DEVICES OR SYSTEMS WITHOUT THE EXPRESS WRITTEN APPROVAL OF FAIRCHILD SEMICONDUCTOR CORPORATION.

As used herein:

1. Life support devices or systems are devices or systems which, (a) are intended for surgical implant into the body, or (b) support or sustain life, or (c) whose failure to perform when properly used in accordance with instructions for use provided in the labeling, can be reasonably expected to result in significant injury to the user.
2. A critical component is any component of a life support device or system whose failure to perform can be reasonably expected to cause the failure of the life support device or system, or to affect its safety or effectiveness.

## PRODUCT STATUS DEFINITIONS

### Definition of Terms

Datasheet Identification	Product Status	Definition
Advance Information	Formative or In Design	This datasheet contains the design specifications for product development. Specifications may change in any manner without notice.
Preliminary	First Production	This datasheet contains preliminary data, and supplementary data will be published at a later date. Fairchild Semiconductor reserves the right to make changes at any time without notice in order to improve design.
No Identification Needed	Full Production	This datasheet contains final specifications. Fairchild Semiconductor reserves the right to make changes at any time without notice in order to improve design.
Obsolete	Not In Production	This datasheet contains specifications on a product that has been discontinued by Fairchild semiconductor. The datasheet is printed for reference information only.