

ADS7820

12-Bit 10 μ s Sampling CMOS ANALOG-to-DIGITAL CONVERTER

FEATURES

- 100kHz min SAMPLING RATE
- 0 to +5V INPUT RANGE
- 72dB min SINAD WITH 45kHz INPUT
- $\pm 1/2$ LSB max INL AND DNL
- SINGLE +5V SUPPLY OPERATION
- PIN-COMPATIBLE WITH 16-BIT ADS7821
- USES INTERNAL OR EXTERNAL REFERENCE
- COMPLETE WITH S/H, REF, CLOCK, ETC.
- FULL PARALLEL DATA OUTPUT
- 100mW max POWER DISSIPATION
- 28-PIN 0.3" PLASTIC DIP AND SOIC

DESCRIPTION

The ADS7820 is a complete 12-bit sampling A/D using state-of-the-art CMOS structures. It contains a complete 12-bit, capacitor-based SAR A/D with S/H, reference, clock, interface for microprocessor use, and three-state output drivers.

The ADS7820 is specified at a 100kHz sampling rate, and guaranteed over the full temperature range. Laser-trimmed scaling resistors provide a 0 to +5V input range, with power dissipation under 100mW.

The 28-pin ADS7820 is available in a plastic 0.3" DIP and in an SOIC, both fully specified for operation over the industrial -40°C to $+85^{\circ}\text{C}$ range.

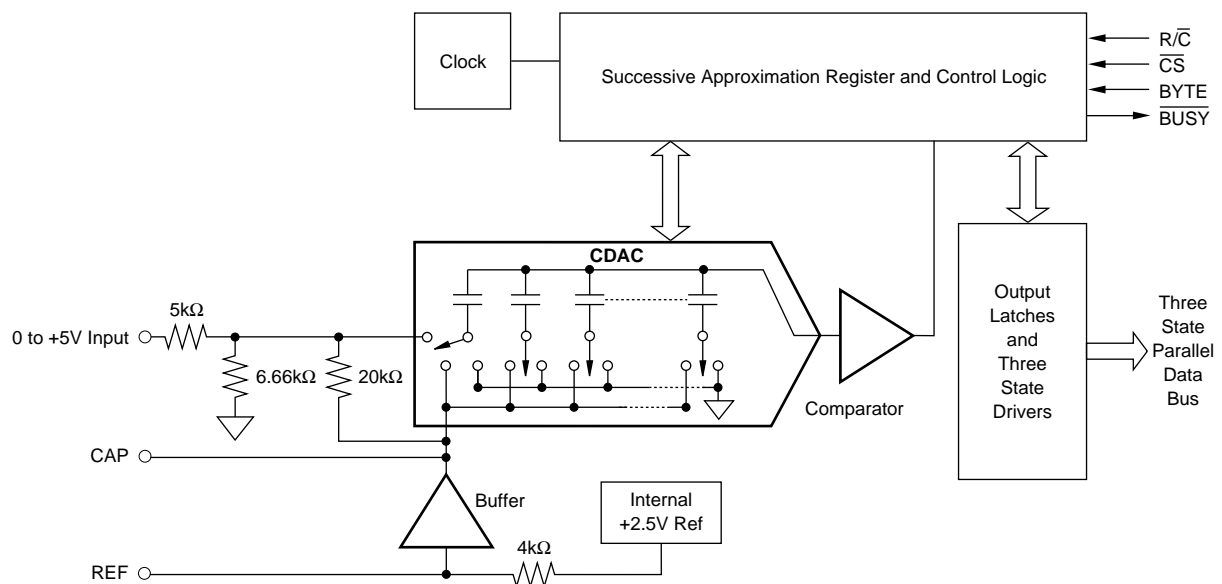

International Airport Industrial Park • Mailing Address: PO Box 11400 • Tucson, AZ 85734 • Street Address: 6730 S. Tucson Blvd. • Tucson, AZ 85706
Tel: (520) 746-1111 • Twx: 910-952-1111 • Cable: BBRCORP • Telex: 066-6491 • FAX: (520) 889-1510 • Immediate Product Info: (800) 548-6132

SPECIFICATIONS

ELECTRICAL

$T_A = -40^{\circ}\text{C}$ to $+85^{\circ}\text{C}$, $f_S = 100\text{kHz}$, $V_{\text{DIG}} = V_{\text{ANA}} = +5\text{V}$, using internal reference, unless otherwise specified.

PARAMETER	CONDITIONS	ADS7820P/U			ADS7820PB/UB			UNITS
		MIN	TYP	MAX	MIN	TYP	MAX	
RESOLUTION				12			*	Bits
ANALOG INPUT Voltage Ranges Impedance Capacitance			0 to +5 10 35			*	*	V k Ω pF
THROUGHPUT SPEED Conversion Time Complete Cycle Throughput Rate	Acquire and Convert	100	5.7 10	8 10	*	*	*	μs μs kHz
DC ACCURACY Integral Linearity Error Differential Linearity Error No Missing Codes Transition Noise ⁽²⁾ Full Scale Error ^(3,4) Full Scale Error Drift Full Scale Error ^(3,4) Full Scale Error Drift Offset Error Offset Error Drift Power Supply Sensitivity ($V_{\text{DIG}} = V_{\text{ANA}} = V_{\text{D}}$)	Ext. 2.5000V Ref Ext. 2.5000V Ref +4.75V < V_{D} < +5.25V		Guaranteed 0.1	± 1.0 ± 1.0 ± 0.5 ± 7 ± 0.5 ± 2 ± 8 ± 2		*	*	LSB ⁽¹⁾ LSB Bits LSB % ppm/ $^{\circ}\text{C}$ % ppm/ $^{\circ}\text{C}$ mV ppm/ $^{\circ}\text{C}$ LSB
AC ACCURACY Spurious-Free Dynamic Range Total Harmonic Distortion Signal-to-(Noise+Distortion) Signal-to-Noise Full-Power Bandwidth ⁽⁶⁾	$f_{\text{IN}} = 45\text{kHz}$ $f_{\text{IN}} = 45\text{kHz}$ $f_{\text{IN}} = 45\text{kHz}$ $f_{\text{IN}} = 45\text{kHz}$	80 70 70		-80	*	*	*	dB ⁽⁵⁾ dB dB dB kHz
SAMPLING DYNAMICS Aperture Delay Transient Response Overvoltage Recovery ⁽⁷⁾	FS Step		40 150	2		*	*	ns μs ns
REFERENCE Internal Reference Voltage Internal Reference Source Current (Must use external buffer.) External Reference Voltage Range for Specified Linearity External Reference Current Drain		2.48	2.5 1	2.52	*	*	*	V μA V μA
DIGITAL INPUTS Logic Levels V_{IL} V_{IH} I_{IL} I_{IH}		-0.3 +2.0		+0.8 $V_{\text{D}} + 0.3\text{V}$ ± 10 ± 10	*	*	*	V V μA μA
DIGITAL OUTPUTS Data Format Data Coding V_{OL} V_{OH} Leakage Current Output Capacitance	$I_{\text{SINK}} = 1.6\text{mA}$ $I_{\text{SOURCE}} = 500\mu\text{A}$ High-Z State, $V_{\text{OUT}} = 0\text{V}$ to V_{DIG} High-Z State	+4		Parallel 12 bits Straight Binary +0.4 ± 5 15	*	*	*	V V μA pF
DIGITAL TIMING Bus Access Time Bus Relinquish Time				83 83		*	*	ns ns

The information provided herein is believed to be reliable; however, BURR-BROWN assumes no responsibility for inaccuracies or omissions. BURR-BROWN assumes no responsibility for the use of this information, and all use of such information shall be entirely at the user's own risk. Prices and specifications are subject to change without notice. No patent rights or licenses to any of the circuits described herein are implied or granted to any third party. BURR-BROWN does not authorize or warrant any BURR-BROWN product for use in life support devices and/or systems.

SPECIFICATIONS (CONT)

ELECTRICAL

T_A = -40°C to +85°C, f_S = 100kHz, V_{DIG} = V_{ANA} = +5V, using internal reference, unless otherwise specified.

PARAMETER	CONDITIONS	ADS7820P/U			ADS7820PB/UB			UNITS
		MIN	TYP	MAX	MIN	TYP	MAX	
POWER SUPPLIES								
Specified Performance	Must be ≤ V _{ANA}				*	*	*	V
V _{DIG}		+4.75	+5	+5.25	*	*	*	V
V _{ANA}		+4.75	+5	+5.25	*	*	*	V
+I _{DIG}						*		mA
+I _{ANA}					*		mA	
Power Dissipation	f _S = 100kHz			100			*	mW
TEMPERATURE RANGE								
Specified Performance		-40		+85	*		*	°C
Derated Performance		-55		+125	*		*	°C
Storage		-65		+150	*		*	°C
Thermal Resistance (θ _{JA})								
Plastic DIP			75			*		°C/W
SOIC			75			*		°C/W

NOTES: (1) LSB means Least Significant Bit. For the 12-bit, 0 to +5V input ADS7820, one LSB is 1.22mV. (2) Typical rms noise at worst case transitions and temperatures. (3) Adjustable to zero with external potentiometer as shown in Figure 4b. (4) Full scale error is the worst case of Full Scale untrimmed deviation from ideal last code transition divided by the transition voltage and includes the effect of offset error. (5) All specifications in dB are referred to a full-scale input. (6) Full-Power Bandwidth defined as Full-Scale input frequency at which Signal-to-(Noise + Distortion) degrades to 60dB, or 10 bits of accuracy. (7) Recovers to specified performance after 2 x FS input overvoltage.

ABSOLUTE MAXIMUM RATINGS

Analog Inputs: V _{IN}	-0.7V to +V _{ANA} +0.3V
REF	+V _{ANA} +0.3V to AGND2 -0.3V
CAP	Indefinite Short to AGND2
	Momentary Short to V _{ANA}
Ground Voltage Differences: DGND, AGND1, AGND2	±0.3V
V _{ANA}	7V
V _{DIG} to V _{ANA}	+0.3V
V _{DIG}	7V
Digital Inputs	-0.3V to +V _{DIG} +0.3V
Maximum Junction Temperature	+165°C
Internal Power Dissipation	825mW
Lead Temperature (soldering, 10s)	+300°C

ELECTROSTATIC DISCHARGE SENSITIVITY

Electrostatic discharge can cause damage ranging from performance degradation to complete device failure. Burr-Brown Corporation recommends that all integrated circuits be handled and stored using appropriate ESD protection methods.

ESD damage can range from subtle performance degradation to complete device failure. Precision integrated circuits may be more susceptible to damage because very small parametric changes could cause the device not to meet published specifications.

PACKAGE INFORMATION

PRODUCT	PACKAGE	PACKAGE DRAWING NUMBER ⁽¹⁾
ADS7820P	Plastic DIP	246
ADS7820PB	Plastic DIP	246
ADS7820U	SOIC	217
ADS7820UB	SOIC	217

NOTE: (1) For detailed drawing and dimension table, please see end of data sheet, or Appendix D of Burr-Brown IC Data Book.

ORDERING INFORMATION

PRODUCT	MAXIMUM LINEARITY ERROR (LSB)	MINIMUM SIGNAL-TO-(NOISE + DISTORTION) RATIO (dB)	SPECIFICATION TEMPERATURE RANGE	PACKAGE
ADS7820P	±1.0	70	-40°C to +85°C	Plastic DIP
ADS7820PB	±0.5	72	-40°C to +85°C	Plastic DIP
ADS7820U	±1.0	70	-40°C to +85°C	SOIC
ADS7820UB	±0.5	72	-40°C to +85°C	SOIC

PIN CONFIGURATION

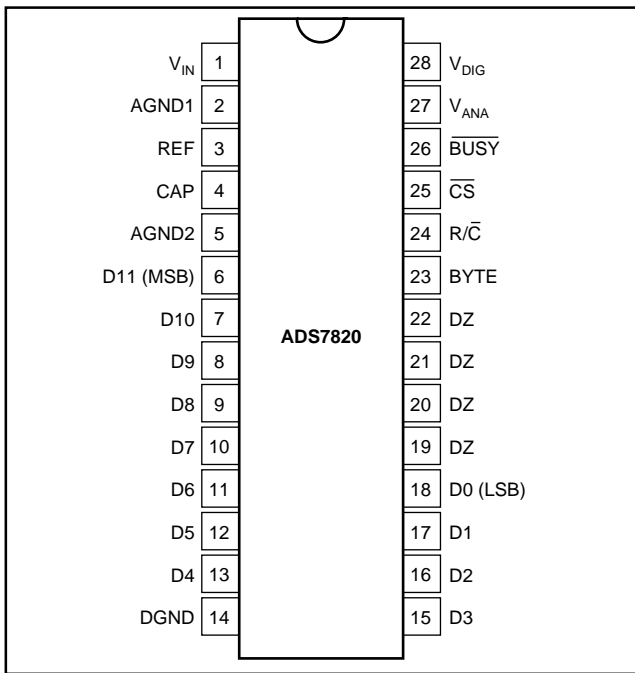

PIN ASSIGNMENTS

PIN #	NAME	DESCRIPTION
1	V _{IN}	Analog Input. Full-scale input range is 0 to +5V.
2	AGND1	Analog Ground. Used internally as ground reference point.
3	REF	Reference Input/Output. Outputs internal reference of +2.5V nominal. Can also be driven by external system reference. In both cases, connect to ground with a 2.2μF Tantalum capacitor.
4	CAP	Reference Buffer Capacitor. 2.2μF Tantalum to ground.
5	AGND2	Analog Ground.
6	D11 (MSB)	Data Bit 11. Most Significant Bit (MSB) of conversion results. Hi-Z state when \overline{CS} is HIGH, or when R/\overline{C} is LOW.
7	D10	Data Bit 10. Hi-Z state when \overline{CS} is HIGH, or when R/\overline{C} is LOW.
8	D9	Data Bit 9. Hi-Z state when \overline{CS} is HIGH, or when R/\overline{C} is LOW.
9	D8	Data Bit 8. Hi-Z state when \overline{CS} is HIGH, or when R/\overline{C} is LOW.
10	D7	Data Bit 7. Hi-Z state when \overline{CS} is HIGH, or when R/\overline{C} is LOW.
11	D6	Data Bit 6. Hi-Z state when \overline{CS} is HIGH, or when R/\overline{C} is LOW.
12	D5	Data Bit 5. Hi-Z state when \overline{CS} is HIGH, or when R/\overline{C} is LOW.
13	D4	Data Bit 4. Hi-Z state when \overline{CS} is HIGH, or when R/\overline{C} is LOW.
14	DGND	Digital Ground.
15	D3	Data Bit 3. Hi-Z state when \overline{CS} is HIGH, or when R/\overline{C} is LOW.
16	D2	Data Bit 2. Hi-Z state when \overline{CS} is HIGH, or when R/\overline{C} is LOW.
17	D1	Data Bit 1. Hi-Z state when \overline{CS} is HIGH, or when R/\overline{C} is LOW.
18	D0 (LSB)	Data Bit 0. Least Significant Bit (LSB) of conversion results. Hi-Z state when \overline{CS} is HIGH, or when R/\overline{C} is LOW.
19	DZ	Data Zero. LOW when \overline{CS} LOW and R/\overline{C} HIGH. Hi-Z state when \overline{CS} is HIGH, or when R/\overline{C} is LOW.
20	DZ	Data Zero. LOW when \overline{CS} LOW and R/\overline{C} HIGH. Hi-Z state when \overline{CS} is HIGH, or when R/\overline{C} is LOW.
21	DZ	Data Zero. LOW when \overline{CS} LOW and R/\overline{C} HIGH. Hi-Z state when \overline{CS} is HIGH, or when R/\overline{C} is LOW.
22	DZ	Data Zero. LOW when \overline{CS} LOW and R/\overline{C} HIGH. Hi-Z state when \overline{CS} is HIGH, or when R/\overline{C} is LOW.
23	BYTE	Byte Select. With BYTE LOW, data will be output as indicated above, causing pin 6 (D11) to output the MSB, and pin 18 (D0) to output the LSB. Pins 19 to 22 will output LOWs. With BYTE HIGH, the top and bottom 8 bits of data will be switched, so that pin 6 outputs data bit 3, pin 9 outputs data bit 0 (LSB), pin 10 to 13 output LOWs, pin 15 outputs data bit 11 (MSB) and pin 22 outputs data bit 4.
24	R/\overline{C}	Read/Convert input. With \overline{CS} LOW, a falling edge on R/\overline{C} puts the internal sample/hold into the hold state and starts a conversion. With \overline{CS} LOW, a rising edge on R/\overline{C} enables the output data bits.
25	\overline{CS}	Chip Select. Internally OR'd with R/\overline{C} . With R/\overline{C} LOW, a falling edge on \overline{CS} will initiate a conversion. With R/\overline{C} HIGH, a falling edge on \overline{CS} will enable the output data bits.
26	\overline{BUSY}	Busy Output. Falls when a conversion is started, and remains LOW until the conversion is completed and the data is latched into the output register. With \overline{CS} LOW and R/\overline{C} HIGH, output data will be valid when \overline{BUSY} rises, so that the rising edge can be used to latch the data. \overline{CS} or R/\overline{C} must be high when \overline{BUSY} rises, or another conversion will start, without time for signal acquisition.
27	V _{ANA}	Analog Supply Input. Nominally +5V. Connect directly to pin 28. Decouple to ground with 0.1μF ceramic and 10μF Tantalum capacitors.
28	V _{DIG}	Digital Supply Input. Nominally +5V. Connect directly to pin 27. Must be $\leq V_{ANA}$.

TYPICAL PERFORMANCE CURVES

At $T_A = -40^{\circ}\text{C}$ to $+85^{\circ}\text{C}$, $f_S = 100\text{kHz}$, $V_{\text{DIG}} = V_{\text{ANA}} = +5\text{V}$, using internal reference, unless otherwise specified.

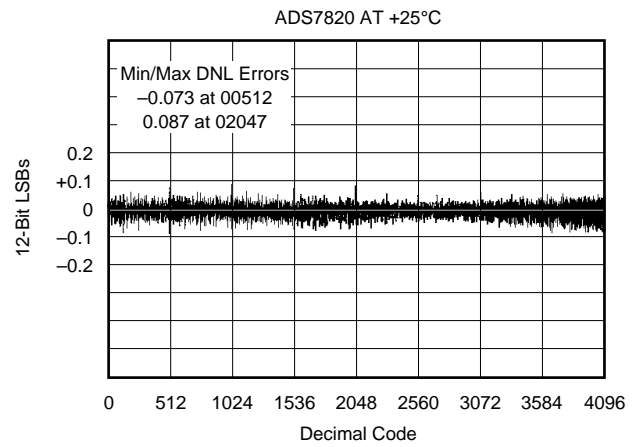
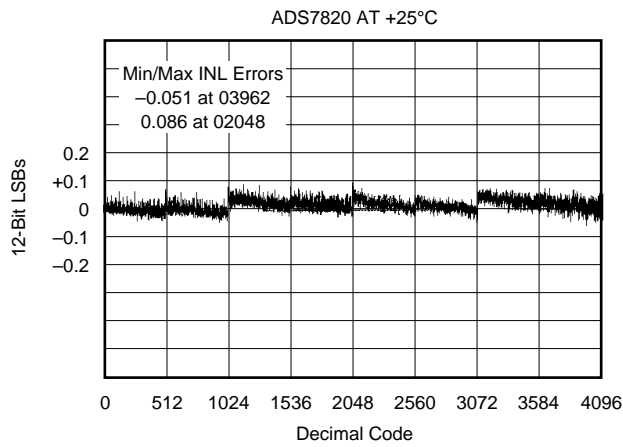
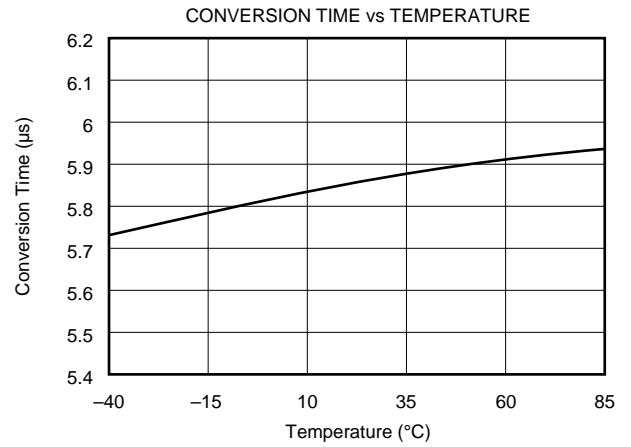
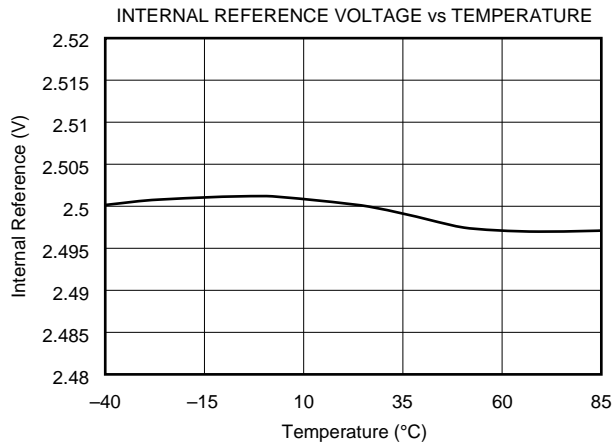

BASIC OPERATION

Figure 1 shows a basic circuit to operate the ADS7820 with a full parallel data output. Taking $\overline{R/C}$ (pin 24) LOW for a minimum of 40ns (5.4µs max) will initiate a conversion. \overline{BUSY} (pin 26) will go LOW and stay LOW until the conversion is completed and the output registers are updated. Data will be output in Straight Binary with the MSB on pin 6. \overline{BUSY} going HIGH can be used to latch the data. All convert commands will be ignored while \overline{BUSY} is LOW.

The ADS7820 will begin tracking the input signal at the end of the conversion. Allowing 10µs between convert commands assures accurate acquisition of a new signal.

STARTING A CONVERSION

The combination of \overline{CS} (pin 25) and $\overline{R/C}$ (pin 24) LOW for a minimum of 40ns immediately puts the sample/hold of the ADS7820 in the hold state and starts conversion 'n'. \overline{BUSY} (pin 26) will go LOW and stay LOW until conversion 'n' is completed and the internal output register has been updated. All new convert commands during \overline{BUSY} LOW will be ignored. \overline{CS} and/or $\overline{R/C}$ must go HIGH before \overline{BUSY} goes HIGH or a new conversion will be initiated without sufficient time to acquire a new signal.

The ADS7820 will begin tracking the input signal at the end of the conversion. Allowing 10µs between convert commands assures accurate acquisition of a new signal. Refer to Table I for a summary of \overline{CS} , $\overline{R/C}$, and \overline{BUSY} states and Figures 3 through 5 for timing diagrams.

\overline{CS} and $\overline{R/C}$ are internally OR'd and level triggered. There is not a requirement which input goes LOW first when initiating a conversion. If, however, it is critical that \overline{CS} or $\overline{R/C}$ initiates conversion 'n', be sure the less critical input is LOW at least 10ns prior to the initiating input.

To reduce the number of control pins, \overline{CS} can be tied LOW using $\overline{R/C}$ to control the read and convert modes. However, the output will become active whenever $\overline{R/C}$ goes HIGH. Refer to the **Reading Data** section.

\overline{CS}	$\overline{R/C}$	\overline{BUSY}	OPERATION
1	X	X	None. Databus is in Hi-Z state.
↓	0	1	Initiates conversion "n". Databus remains in Hi-Z state.
0	↓	1	Initiates conversion "n". Databus enters Hi-Z state.
0	1	↑	Conversion "n" completed. Valid data from conversion "n" on the databus.
↓	1	1	Enables databus with valid data from conversion "n".
↓	1	0	Enables databus with valid data from conversion "n-1" ⁽¹⁾ . Conversion n in process.
0	↑	0	Enables databus with valid data from conversion "n-1" ⁽¹⁾ . Conversion "n" in process.
0	0	↑	New conversion initiated without acquisition of a new signal. Data will be invalid. \overline{CS} and/or $\overline{R/C}$ must be HIGH when \overline{BUSY} goes HIGH.
X	X	0	New convert commands ignored. Conversion "n" in process.

NOTE: (1) See Figures 2 and 3 for constraints on data valid from conversion "n-1".

Table I. Control Line Functions for "Read" and "Convert".

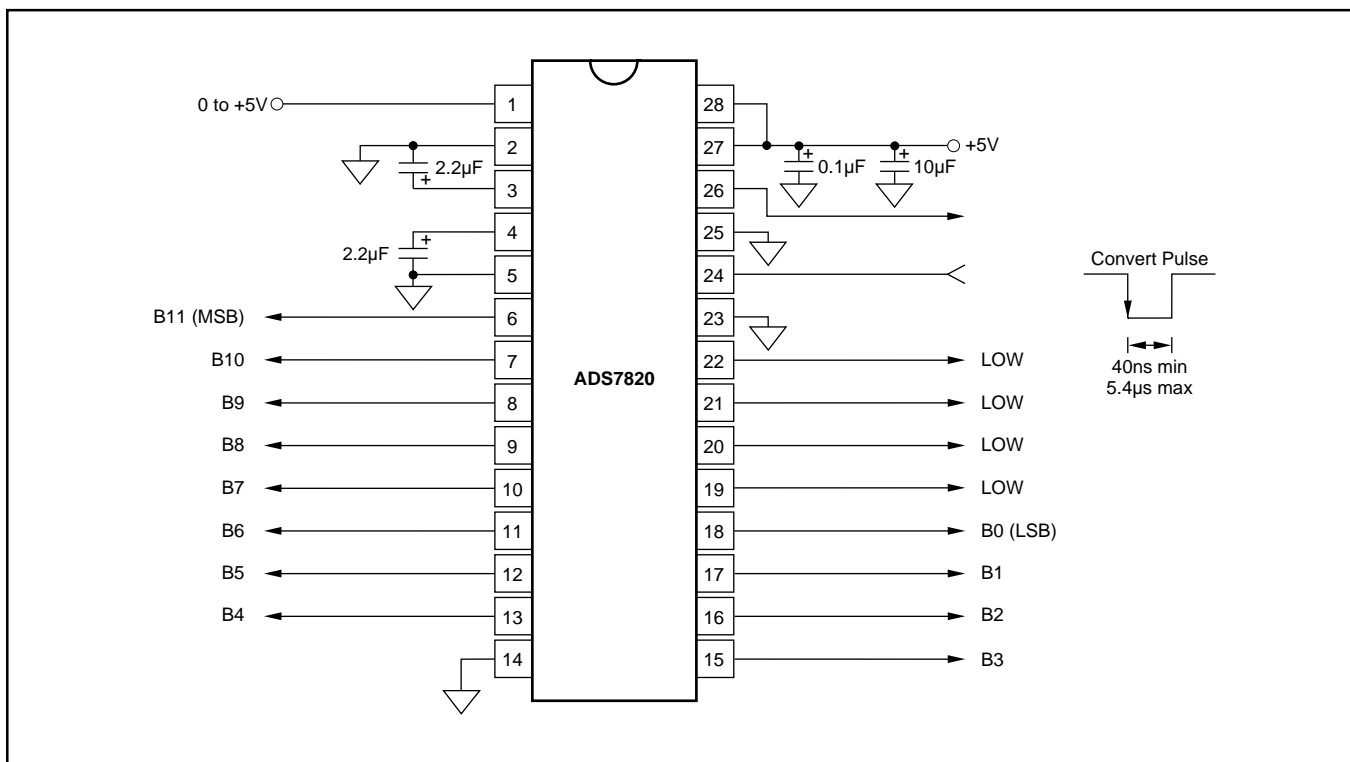

FIGURE 1. Basic Operation (Byte Low).

READING DATA

The ADS7820 outputs full or byte-reading parallel data in Straight Binary data output format. The parallel output will be active when $\overline{R/C}$ (pin 24) is HIGH and \overline{CS} (pin 25) is LOW. Any other combination of \overline{CS} and $\overline{R/C}$ will tri-state the parallel output. Valid conversion data can be read in a full parallel, 12-bit word or two 8-bit bytes on pins 6-13 and pins 15-22. BYTE (pin 23) can be toggled to read both bytes within one conversion cycle. Refer to Table II for ideal output codes and Figure 2 for bit locations relative to the state of BYTE.

DESCRIPTION	ANALOG INPUT	DIGITAL OUTPUT STRAIGHT BINARY	
		BINARY CODE	HEX CODE
Full Scale Range	0 to +5V		
Least Significant Bit (LSB)	1.22mV		
Full Scale	4.99878V	1111 1111 1111	FFF
Midscale	2.5V	1000 0000 0000	800
One LSB below Midscale	2.49878V	0111 1111 1111	7FF
Zero Scale	0V	0000 0000 0000	0

Table II. Ideal Input Voltages and Output Codes.

PARALLEL OUTPUT (After a Conversion)

After conversion 'n' is completed and the output registers have been updated, \overline{BUSY} (pin 26) will go HIGH. Valid data from conversion 'n' will be available on D11-D0 (pin 6-13 and 15-18 when BYTE is LOW). \overline{BUSY} going HIGH can be used to latch the data. Refer to Table III and Figures 3 and 5 for timing specifications.

PARALLEL OUTPUT (During a Conversion)

After conversion 'n' has been initiated, valid data from conversion 'n-1' can be read and will be valid up to 16µs after the start of conversion 'n'. Do not attempt to read data from 16µs after the start of conversion 'n' until \overline{BUSY} (pin 26) goes HIGH; this may result in reading invalid data. Refer to Table III and Figures 3 and 5 for timing specifications.

Note! For the best possible performance, data should not be read during a conversion. The switching noise of the asynchronous data transfer can cause digital feedthrough degrading the converter's performance.

The number of control lines can be reduced by tying \overline{CS} LOW while using $\overline{R/C}$ to initiate conversions and activate the output mode of the converter. See Figure 3.

SYMBOL	DESCRIPTION	MIN	TYP	MAX	UNITS
t_1	Convert Pulse Width	40		5400	ns
t_2	Data Valid Delay after $\overline{R/C}$ LOW			8	µs
t_3	\overline{BUSY} Delay from $\overline{R/C}$ LOW			65	ns
t_4	\overline{BUSY} LOW			8	µs
t_5	\overline{BUSY} Delay after End of Conversion		220		ns
t_6	Aperture Delay		40		ns
t_7	Conversion Time		7.6	8	µs
t_8	Acquisition Time			2	µs
t_9	Bus Relinquish Time	10	35	83	ns
t_{10}	\overline{BUSY} Delay after Data Valid	50	200		ns
t_{11}	Previous Data Valid after $\overline{R/C}$ LOW		7.4		µs
$t_7 + t_6$	Throughput Time		9	10	µs
t_{12}	$\overline{R/C}$ to \overline{CS} Setup Time	10			ns
t_{13}	Time Between Conversions	10			µs
t_{14}	Bus Access Time and BYTE Delay	10		83	ns

TABLE III. Conversion Timing.

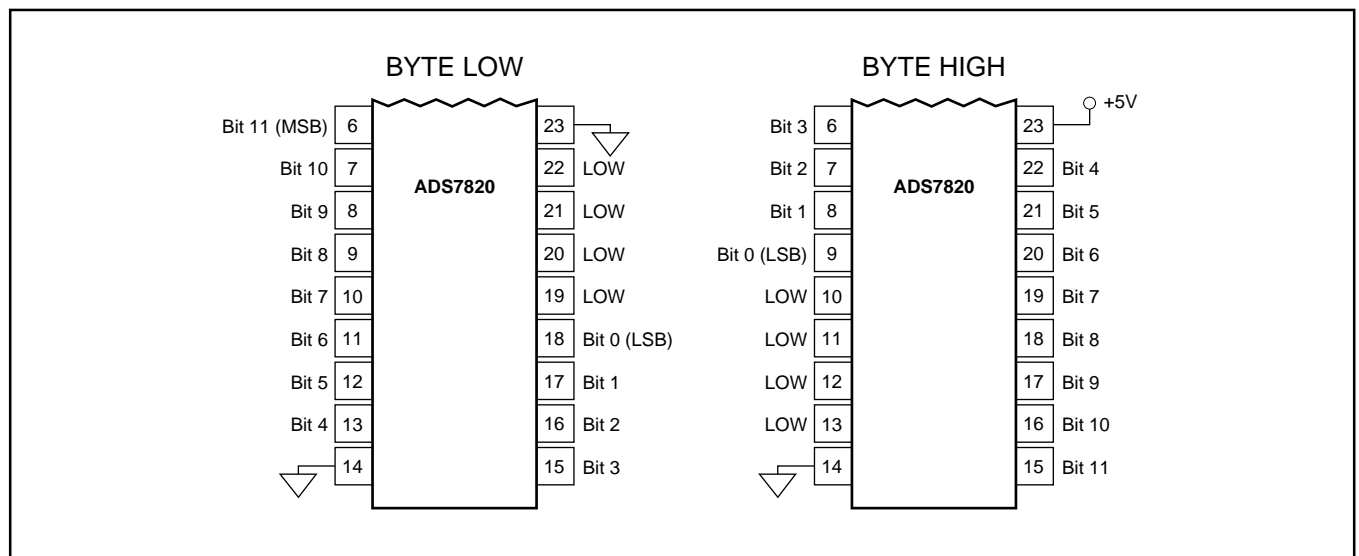

FIGURE 2. Bit Locations Relative to State of BYTE (pin 23).

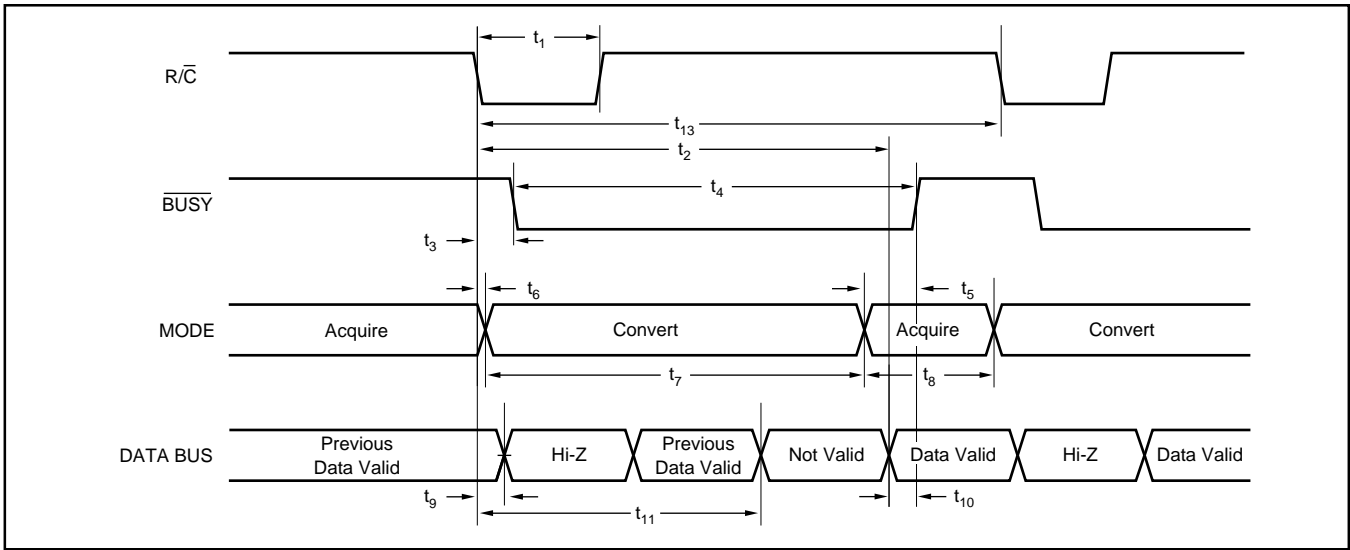

FIGURE 3. Conversion Timing with Outputs Enabled after Conversion (\overline{CS} Tied LOW.)

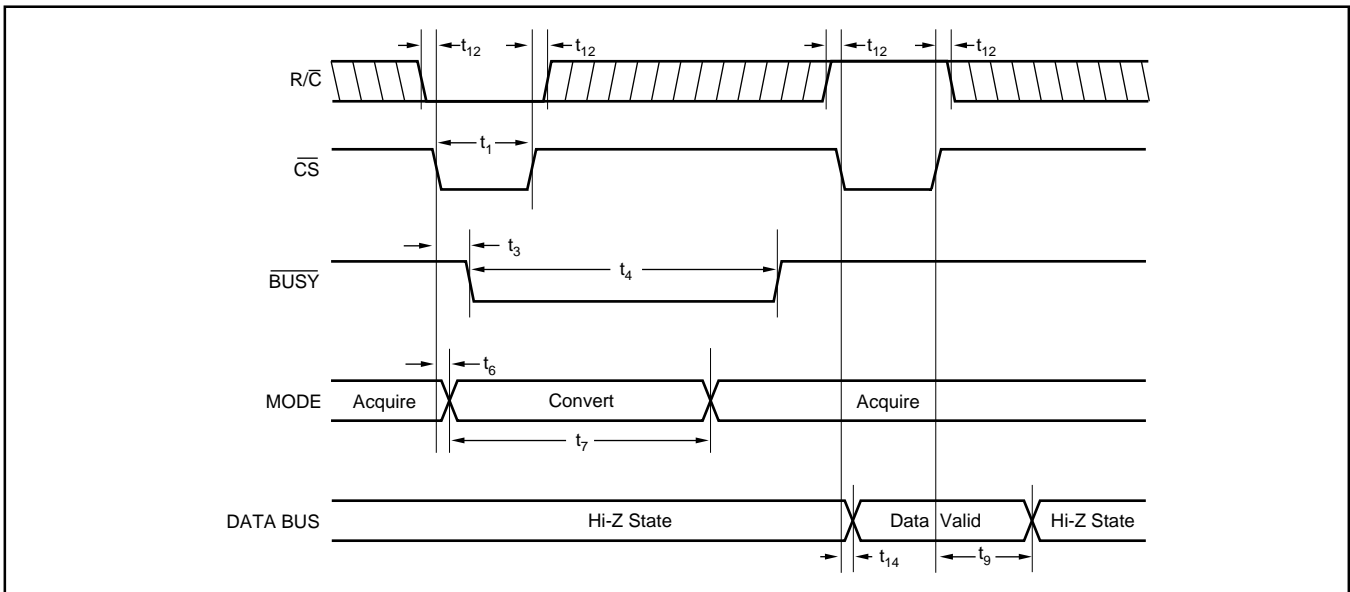

FIGURE 4. Using \overline{CS} to Control Conversion and Read Timing.

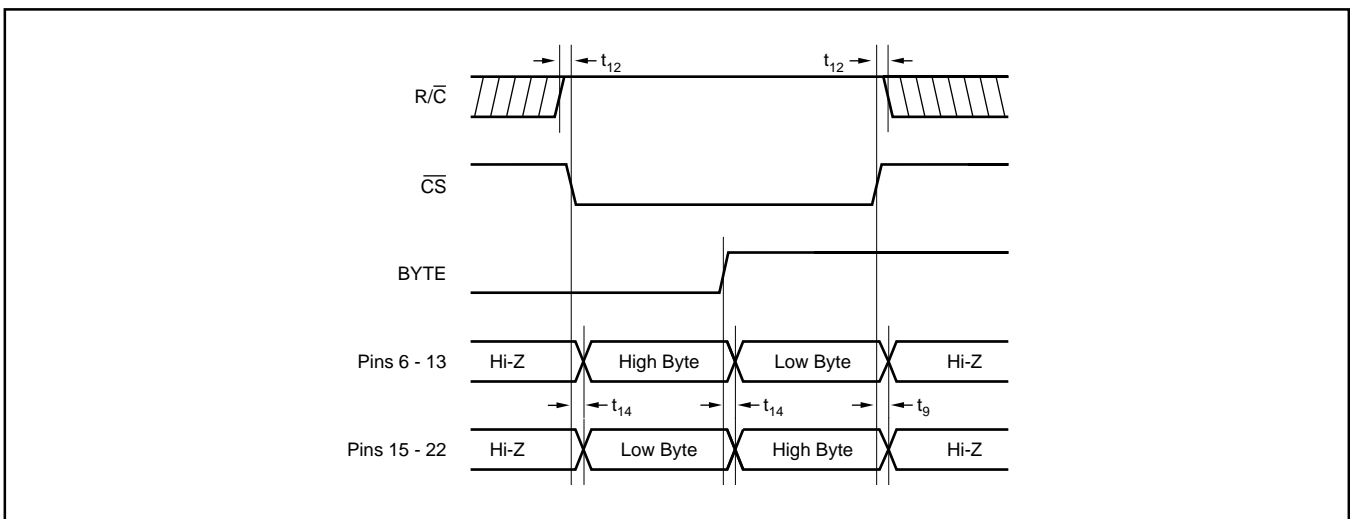

FIGURE 5. Using \overline{CS} and BYTE to Control Data Bus.

INPUT RANGE

The ADS7820 offers a standard 0V to 5V input range. Figure 6 shows the required circuit connections for the ADS7820 with and without the gain adjustment hardware. Adjustments for offset and gain are described in the calibration section of this data sheet.

CALIBRATION

The ADS7820 can be trimmed in hardware or software. There is no external, offset adjustment. If offset adjustment is required, an op amp featuring an offset trim pin should be used to drive the ADS7820. The offset should be trimmed before the gain since the offset directly affects the gain. To achieve optimum performance, several iterations may be required.

GAIN ADJUSTMENT

To calibrate the gain of the ADS7820, a 576k Ω resistor must be tied between the REF pin and a 5V potentiometer (see Figure 6b). The calibration range is $\pm 15\text{mV}$ for the gain.

REFERENCE

The ADS7820 can operate with its internal 2.5V reference or an external reference. By applying an external reference to pin 3, the internal reference can be bypassed. The reference voltage at REF is buffered internally with the output on CAP (pin 4).

The internal reference has an 8 ppm/ $^{\circ}\text{C}$ drift (typical) and accounts for approximately 20% of the full scale error (FSE = $\pm 0.5\%$ for low grade, $\pm 0.25\%$ for high grade).

REF

REF (pin 3) is an input for an external reference or the output for the internal 2.5V reference. A 2.2 μF capacitor should be connected as close to the REF pin as possible. The capacitor and the output resistance of REF create a low pass filter to bandlimit noise on the reference. Using a smaller value capacitor will introduce more noise to the reference degrading the SNR and SINAD. The REF pin should not be used to drive external AC or DC loads.

The range for the external reference is 2.3V to 2.7V and determines the actual LSB size. Increasing the reference voltage will increase the full scale range and the LSB size of the converter which can improve the SNR.

CAP

CAP (pin 4) is the output of the internal reference buffer. A 2.2 μF capacitor should be placed as close to the CAP pin as possible to provide optimum switching currents for the CDAC throughout the conversion cycle and compensation for the output of the internal buffer. Using a capacitor any smaller than 1 μF can cause the output buffer to oscillate and may not have sufficient charge for the CDAC. Capacitor values larger than 2.2 μF will have little affect on improving performance.

The output of the buffer is capable of driving up to 2mA of current to a DC load. DC loads requiring more than 2mA of current from the CAP pin will begin to degrade the linearity of the ADS7820. Using an external buffer will allow the internal reference to be used for larger DC loads and AC loads. Do not attempt to directly drive an AC load with the output voltage on CAP. This will cause performance degradation of the converter.

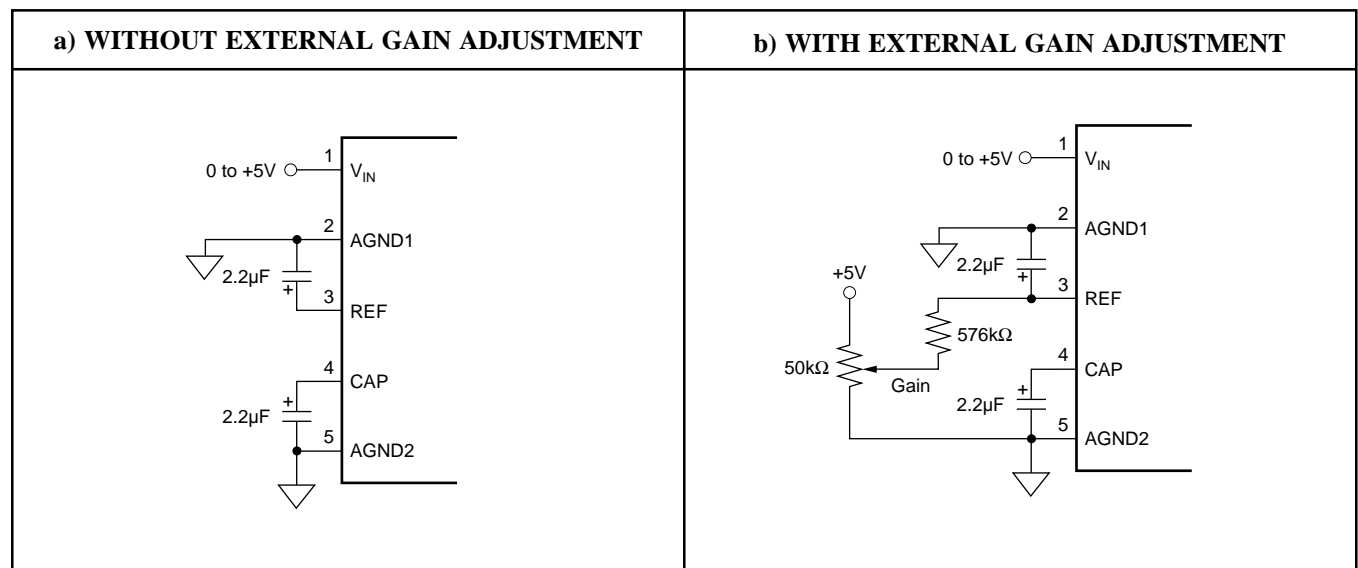

FIGURE 6. Circuit Diagram With and Without External Gain Adjustment.

LAYOUT

POWER

For optimum performance, tie the analog and digital power pins to the same +5V power supply and tie the analog and digital grounds together. As noted in the electrical specifications, the ADS7820 uses 90% of its power for the analog circuitry. The ADS7820 should be considered as an analog component.

The +5V power for the A/D should be separate from the +5V used for the system's digital logic. Connecting V_{DIG} (pin 28) directly to a digital supply can reduce converter performance due to switching noise from the digital logic. For best performance, the +5V supply can be produced from whatever analog supply is used for the rest of the analog signal conditioning. If +12V or +15V supplies are present, a simple +5V regulator can be used. Although it is not suggested, if the digital supply must be used to power the converter, be sure to properly filter the supply. Either using a filtered digital supply or a regulated analog supply, both V_{DIG} and V_{ANA} should be tied to the same +5V source.

GROUNDING

Three ground pins are present on the ADS7820. DGND is the digital supply ground. AGND2 is the analog supply ground. AGND1 is the ground which all analog signals internal to the A/D are referenced. AGND1 is more susceptible to current induced voltage drops and must have the path of least resistance back to the power supply.

All the ground pins of the A/D should be tied to the analog ground plane, separated from the system's digital logic ground, to achieve optimum performance. Both analog and digital ground planes should be tied to the "system" ground as near to the power supplies as possible. This helps to prevent dynamic digital ground currents from modulating the analog ground through a common impedance to power ground.

SIGNAL CONDITIONING

The FET switches used for the sample hold on many CMOS A/D converters release a significant amount of charge injection which can cause the driving op amp to oscillate. The FET switch on the ADS7820, compared to the FET switches on other CMOS A/D converters, releases 5%-10% of the charge. There is also a resistive front end which attenuates any charge which is released. The end result is a minimal requirement for the anti-alias filter on the front end. Any op amp sufficient for the signal in an application will be sufficient to drive the ADS7820.

INTERMEDIATE LATCHES

The ADS7820 does have tri-state outputs for the parallel port, but intermediate latches should be used if the bus will be active during conversions. If the bus is not active during conversion, the tri-state outputs can be used to isolate the A/D from other peripherals on the same bus. Tri-state outputs can also be used when the A/D is the only peripheral on the data bus.

Intermediate latches are beneficial on any monolithic A/D converter. The ADS7820 has an internal LSB size of $610\mu V$. Transients from fast switching signals on the parallel port, even when the A/D is tri-stated, can be coupled through the substrate to the analog circuitry causing degradation of converter performance. The effects of this phenomenon will be more obvious when using the pin-compatible ADS7821 or any of the other 16-bit converters in the ADS Family. This is due to the smaller internal LSB size of $38\mu V$.

PACKAGING INFORMATION

Orderable Device	Status ⁽¹⁾	Package Type	Package Drawing	Pins	Package Qty	Eco Plan ⁽²⁾	Lead/Ball Finish	MSL Peak Temp ⁽³⁾
ADS7820P	OBSOLETE	PDIP	NT	28		None	Call TI	Call TI
ADS7820PB	OBSOLETE	PDIP	NT	28		None	Call TI	Call TI
ADS7820U	OBSOLETE	SOIC	DW	28		None	Call TI	Call TI
ADS7820U/1K	OBSOLETE	SOIC	DW	28		None	Call TI	Call TI
ADS7820UB	OBSOLETE	SOIC	DW	28		None	Call TI	Call TI
ADS7820UB/1K	OBSOLETE	SOIC	DW	28		None	Call TI	Call TI

⁽¹⁾ The marketing status values are defined as follows:

ACTIVE: Product device recommended for new designs.

LIFEBUY: TI has announced that the device will be discontinued, and a lifetime-buy period is in effect.

NRND: Not recommended for new designs. Device is in production to support existing customers, but TI does not recommend using this part in a new design.

PREVIEW: Device has been announced but is not in production. Samples may or may not be available.

OBSOLETE: TI has discontinued the production of the device.

⁽²⁾ Eco Plan - May not be currently available - please check <http://www.ti.com/productcontent> for the latest availability information and additional product content details.

None: Not yet available Lead (Pb-Free).

Pb-Free (RoHS): TI's terms "Lead-Free" or "Pb-Free" mean semiconductor products that are compatible with the current RoHS requirements for all 6 substances, including the requirement that lead not exceed 0.1% by weight in homogeneous materials. Where designed to be soldered at high temperatures, TI Pb-Free products are suitable for use in specified lead-free processes.

Green (RoHS & no Sb/Br): TI defines "Green" to mean "Pb-Free" and in addition, uses package materials that do not contain halogens, including bromine (Br) or antimony (Sb) above 0.1% of total product weight.

⁽³⁾ MSL, Peak Temp. -- The Moisture Sensitivity Level rating according to the JEDEC industry standard classifications, and peak solder temperature.

Important Information and Disclaimer: The information provided on this page represents TI's knowledge and belief as of the date that it is provided. TI bases its knowledge and belief on information provided by third parties, and makes no representation or warranty as to the accuracy of such information. Efforts are underway to better integrate information from third parties. TI has taken and continues to take reasonable steps to provide representative and accurate information but may not have conducted destructive testing or chemical analysis on incoming materials and chemicals. TI and TI suppliers consider certain information to be proprietary, and thus CAS numbers and other limited information may not be available for release.

In no event shall TI's liability arising out of such information exceed the total purchase price of the TI part(s) at issue in this document sold by TI to Customer on an annual basis.

IMPORTANT NOTICE

Texas Instruments Incorporated and its subsidiaries (TI) reserve the right to make corrections, modifications, enhancements, improvements, and other changes to its products and services at any time and to discontinue any product or service without notice. Customers should obtain the latest relevant information before placing orders and should verify that such information is current and complete. All products are sold subject to TI's terms and conditions of sale supplied at the time of order acknowledgment.

TI warrants performance of its hardware products to the specifications applicable at the time of sale in accordance with TI's standard warranty. Testing and other quality control techniques are used to the extent TI deems necessary to support this warranty. Except where mandated by government requirements, testing of all parameters of each product is not necessarily performed.

TI assumes no liability for applications assistance or customer product design. Customers are responsible for their products and applications using TI components. To minimize the risks associated with customer products and applications, customers should provide adequate design and operating safeguards.

TI does not warrant or represent that any license, either express or implied, is granted under any TI patent right, copyright, mask work right, or other TI intellectual property right relating to any combination, machine, or process in which TI products or services are used. Information published by TI regarding third-party products or services does not constitute a license from TI to use such products or services or a warranty or endorsement thereof. Use of such information may require a license from a third party under the patents or other intellectual property of the third party, or a license from TI under the patents or other intellectual property of TI.

Reproduction of information in TI data books or data sheets is permissible only if reproduction is without alteration and is accompanied by all associated warranties, conditions, limitations, and notices. Reproduction of this information with alteration is an unfair and deceptive business practice. TI is not responsible or liable for such altered documentation.

Resale of TI products or services with statements different from or beyond the parameters stated by TI for that product or service voids all express and any implied warranties for the associated TI product or service and is an unfair and deceptive business practice. TI is not responsible or liable for any such statements.

Following are URLs where you can obtain information on other Texas Instruments products and application solutions:

Products		Applications	
Amplifiers	amplifier.ti.com	Audio	www.ti.com/audio
Data Converters	dataconverter.ti.com	Automotive	www.ti.com/automotive
DSP	dsp.ti.com	Broadband	www.ti.com/broadband
Interface	interface.ti.com	Digital Control	www.ti.com/digitalcontrol
Logic	logic.ti.com	Military	www.ti.com/military
Power Mgmt	power.ti.com	Optical Networking	www.ti.com/opticalnetwork
Microcontrollers	microcontroller.ti.com	Security	www.ti.com/security
		Telephony	www.ti.com/telephony
		Video & Imaging	www.ti.com/video
		Wireless	www.ti.com/wireless

Mailing Address: Texas Instruments
Post Office Box 655303 Dallas, Texas 75265