

## ISOLATED DC/DC CONVERTERS

48 Vdc Input 12 Vdc/12 A, 3.3 Vdc/46 A, 5 Vdc/30 A, 1.2-2.5 Vdc/50 A Outputs



### 0RQB-C5T Series

RoHS Compliant

Rev.B

- Isolated
- High Efficiency
- High Power Density
- Low Cost
- Input Under Voltage Lockout
- Fixed Frequency (330 kHz)
- Active Low/High (Option)
- UL60950-1 Recognized (UL/cUL)
- Output Over Voltage Shutdown
- OCP/SCP
- Over Temperature Protection
- Remote On/Off
- Output Voltage Trim
- Positive/Negative Remote Sense
- Input Over Voltage Lockout
- Basic Isolation

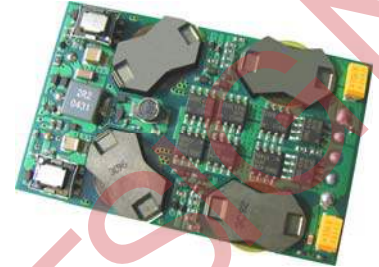

### Description

The 0RQB-C5T Series are isolated dc/dc converters that operate from a nominal 48 Vdc source. These units will provide up to 150 W of output power from a nominal 48 Vdc input. These units are designed to be highly efficient and low cost. Typical efficiency of 12 Vdc output at 48 Vdc input at full load is 93%. Features include remote on/off, over current protection and under-voltage lockout. These converters are provided in an industry standard quarter brick package.

### Part Selection

Output Voltage	Input Voltage	Max. Output Current	Max. Output Power	Typical Efficiency	Model Number Active High	Model Number Active Low
12 V	36 V - 75 V	12 A	144 W	93.0%	0RQB-C5T120	0RQB-C5T12L
5.0 V	36 V - 75 V	30 A	150 W	92.5%	0RQB-C5T050	0RQB-C5T05L
3.3 V	36 V - 75 V	46 A	152 W	91.0%	0RQB-C5T033	0RQB-C5T03L
2.5 V	36 V - 75 V	50 A	125 W	90.5%	0RQB-C5T025	0RQB-C5T02L
1.8 V	36 V - 75 V	50 A	90 W	88.0%	0RQB-C5TV80	0RQB-C5TV8L
1.5 V	36 V - 75 V	50 A	75 W	85.0%	0RQB-C5TV50	0RQB-C5TV5L
1.2 V	36 V - 75 V	50 A	60 W	83.0%	0RQB-C5TV20	0RQB-C5TV2L

**Notes:** 1. Add "G" suffix at the end of the model number to indicate Tray Packaging.

2. All part numbers above indicate RoHS 6. Change the second letter "R" to "7" for RoHS 5 part numbers.

### Absolute Maximum Ratings

Parameter	Min	Typ	Max	Notes
Input Voltage (continuous)	-0.3 V	-	80 V	
Remote On/Off	-0.3 V	-	18 V	
I/O Isolation Voltage	-	-	2000 V	
Ambient Temperature	-40 °C	-	85 °C	
Storage Temperature	-55 °C	-	125 °C	

**Note:** All specifications are typical at nominal input, full load at 25 °C unless noted.

## ISOLATED DC/DC CONVERTERS

48 Vdc Input 12 Vdc/12 A, 3.3 Vdc/46 A, 5 Vdc/30 A, 1.2-2.5 Vdc/50 A Outputs



### Input Specifications

Parameter	Min	Typ	Max	Notes
Input Voltage	36 V	48 V	75 V	
Input Current (full load)				
Vo=12 V	-	-	4.5 A	
Vo=5.0 V	-	-	4.9 A	
Vo=3.3 V	-	-	4.9 A	
Vo=2.5 V	-	-	4.1 A	
Vo=1.8 V	-	-	3.0 A	
Vo=1.5 V	-	-	2.6 A	
Vo=1.2 V	-	-	2.1 A	
Input Current (no load)	-	120 mA	180 mA	
Remote Off Input Current		10 mA	15 mA	
Input Reflected Ripple Current (pk-pk)	-	10 mA	15 mA	Tested with simulated source impedance of 10 $\mu$ H, 5 Hz to 20 MHz; use a 100 $\mu$ F /100 V electrolytic capacitor with ESR = 1 ohm max. at 200 kHz at 25 °C.
Input Reflected Ripple Current (rms)	-	1.5 mA	3 mA	
I <sup>2</sup> t Inrush Current Transient	-	0.05 A <sup>2</sup> s	0.1 A <sup>2</sup> s	
Turn-on Voltage Threshold	32 V	34 V	35 V	
Turn-off Voltage Threshold	30 V	32 V	34 V	
Input over voltage Lockout	76 V	78 V	80 V	

**Note:** All specifications are typical at nominal input, full load at 25 °C unless noted.

### Output Specifications

Parameter	Min	Typ	Max	Notes
Output Voltage Set Point				
Vo=12 V	11.790 V	12.030 V	12.270 V	Vin=48 V, Io=50% full load
Vo=5.0 V	4.925 V	5.004 V	5.075 V	
Vo=3.3 V	3.260 V	3.308 V	3.360 V	
Vo=2.5 V	2.450 V	2.503 V	2.550 V	
Vo=1.8 V	1.770 V	1.808 V	1.844 V	
Vo=1.5 V	1.477 V	1.500 V	1.523 V	
Vo=1.2 V	1.176 V	1.200 V	1.224 V	
Output Voltage Set Point	-3.5%Vo,set	-	3.5%Vo,set	Over all operating input voltage, resistive load, and temperature conditions.
Line Regulation				
Vo=12 V	-	±8 mV	±15 mV	
Vo=5.0 V	-	±5 mV	±15 mV	
Vo=1.2 V-3.3 V	-	±3 mV	±6 mV	
Load Regulation				
Vo=5.0 V-12 V	-	±10 mV	±20 mV	
Vo=2.5 V-3.3 V	-	±5 mV	±10 mV	
Vo=1.2 V-1.8 V	-	±2 mV	±5 mV	
Regulation Over Temperature (-40 °C to +85 °C)				
Vo=12 V	-	±60 mV	±100 mV	
Vo=5.0 V	-	±40 mV	±65 mV	
Vo=3.3 V	-	±30 mV	±50 mV	
Vo=2.5 V	-	±20 mV	±40 mV	
Vo=1.8 V-1.2 V	-	±15 mV	±30 mV	
Output Current				
Vo=12 V	0 A	-	12 A	
Vo=5.0 V	0 A	-	30 A	
Vo=3.3 V	0 A	-	46 A	
Vo=1.2 V-2.5 V	0 A	-	50 A	

# ISOLATED DC/DC CONVERTERS

48 Vdc Input 12 Vdc/12 A, 3.3 Vdc/46 A, 5 Vdc/30 A, 1.2-2.5 Vdc/50 A Outputs



## Output Specifications (continued)

Parameter		Min	Typ	Max	Notes	
Current Limit Threshold	Vo=12 V	14 A	15.5 A	18 A		
	Vo=5.0 V	35 A	40 A	45 A		
	Vo=3.3 V	50 A	60 A	65 A		
	Vo=1.2 V-2.5 V	55 A	60 A	65 A		
Short Circuit Surge Transient		-	3 A <sup>2</sup> s	5 A <sup>2</sup> s		
Ripple and Noise (rms)	Vo=12 V	-	25 mV	30 mV	Test conditions: 0-20 MHz BW, with a 1 uF ceramic capacitor and a 10 uF Tantalum capacitor at the output.	
	Vo=5.0 V	-	20 mV	25 mV		
	Vo=3.3 V	-	20 mV	20 mV		
	Vo=1.2 V-2.5 V	-	15 mV	20 mV		
Ripple and Noise (pk-pk)	Vo=12 V	-	70 mV	90 mV		
	Vo=5.0 V	-	60 mV	80 mV		
	Vo=3.3 V	-	50 mV	70 mV		
	Vo=1.8 V	-	45 mV	60 mV		
	Vo=2.5 V	-	40 mV	60 mV		
	Vo=1.5 V	-	55 mV	70 mV		
	Vo=1.2 V	-	40 mV	60 mV		
Turn on Time		10 mS	-	100 mS		
Overshoot at Turn on		-	0%	5%		
Output Capacitance	Vo=12.0 V	0 uF	-	2200 uF		
	Vo=5.0 V	0 uF	-	10000 uF		
	Vo=1.2 V-3.3 V	0 uF	-	20000 uF		
<b>Transient Response</b>						
50% ~ 75% Max Load	Overshoot	Vo=12.0 V	-	600 mV	800 mV	Test conditions: di/dt = 0.1 A/uS, Vin=48 V, with a 1 uF ceramic capacitor and a 10 uF Tantalum capacitor at the output.
	Settling Time		-	200 uS	300 uS	
75% ~ 50% Max Load	Overshoot	Vo=12.0 V	-	600 mV	800 mV	
	Settling Time		-	200 uS	300 uS	
50% ~ 75% Max Load	Overshoot	Vo=5.0 V	-	250 mV	375 mV	
	Settling Time		-	100 uS	200 uS	
75% ~ 50% Max Load	Overshoot	Vo=5.0 V	-	250 mV	375 mV	
	Settling Time		-	100 uS	200 uS	
50% ~ 75% Max Load	Overshoot	Vo=3.3 V	-	100 mV	200 mV	
	Settling Time		-	200 uS	300 uS	
75% ~ 50% Max Load	Overshoot	Vo=3.3 V	-	100 mV	200 mV	
	Settling Time		-	200 uS	300 uS	
50% ~ 75% Max Load	Overshoot	Vo=2.5 V	-	100 mV	200 mV	
	Settling Time		-	300 uS	400 uS	
75% ~ 50% Max Load	Overshoot	Vo=2.5 V	-	100 mV	200 mV	
	Settling Time		-	300 uS	400 uS	
50% ~ 75% Max Load	Overshoot	Vo=1.8 V	-	100 mV	140 mV	
	Settling Time		-	200 uS	300 uS	
75% ~ 50% Max Load	Overshoot	Vo=1.5 V	-	100 mV	140 mV	
	Settling Time		-	200 uS	300 uS	
50% ~ 75% Max Load	Overshoot	Vo=1.2 V	-	100 mV	120 mV	
	Settling Time		-	200 uS	300 uS	
75% ~ 50% Max Load	Overshoot	Vo=1.2 V	-	100 mV	120 mV	
	Settling Time		-	200 uS	300 uS	

**Note:** All specifications are typical at nominal input, full load at 25 °C unless noted.

## ISOLATED DC/DC CONVERTERS

48 Vdc Input 12 Vdc/12 A, 3.3 Vdc/46 A, 5 Vdc/30 A, 1.2-2.5 Vdc/50 A Outputs



### General Specifications

Parameter	Min	Typ	Max	Notes	
Efficiency	Vo=12 V	90%	93%	-	Vin=48 V, full load, Ta=25 °C
	Vo=5.0 V	89%	92.5%	-	
	Vo=3.3 V	88%	91%	-	
	Vo=2.5 V	87%	90.5%	-	
	Vo=1.8 V	85%	88%	-	
	Vo=1.5 V	82%	85%	-	
	Vo=1.2 V	80%	83%	-	
Switching Frequency	280 kHz	330 kHz	380 kHz		
Isolation capacitance	-	1500 pF	-		
Input to Output Isolation Voltage	-	-	2000 V		
Remote Sense Compensation	-	-	10% Vo	The total voltage increased by trim and remote sense should not exceed 10%Vo.	
Output Voltage Trim Range	80% Vo	-	110% Vo		
Over Temperature Protection	-	125 °C	-		
Over Voltage Protection	-	130% Vo	-	Vin=48V, full load, Hiccup mode	
MTBF	1,109,917 hours			Calculated Per Bell Core SR-332 (Io =80% load, Vin=48 V, Vo=3.3 V; Ta = 25 °C)	
Dimensions	Inches	2.30 x 1.45 x 0.395			
	millimeters	58.42 x 36.83 x 10.03			
Weight	-	41 g	-		

**Note:** All specifications are typical at nominal input, full load at 25 °C unless noted.

### Control Specifications

Parameter	Min	Typ	Max	Notes	
<b>Remote On/Off</b>					
Signal Low (Unit On)	Active Low	-0.3 V	-	0.8 V	0RQB-C5TxxL. The remote on/off pin open, Unit off.
Signal High (Unit Off)		2.4 V	-		
Signal Low (Unit Off)	Active High	-0.3 V	-	0.8 V	0RQB-C5Txx0. The remote on/off pin open, Unit on.
Signal High (Unit On)		2.4 V	-		
Current Sink	0 mA	-	0.75 mA		

## ISOLATED DC/DC CONVERTERS

48 Vdc Input 12 Vdc/12 A, 3.3 Vdc/46 A, 5 Vdc/30 A, 1.2-2.5 Vdc/50 A Outputs

**bel**  
POWER PRODUCTS

### Output Trim Equations

Equations for calculating the trim resistor are shown below (Unit: kΩ). The Trim Down resistor should be connected between the Trim pin and Ground pin. The Trim Up resistor should be connected between the Trim pin and the Vout. Only one of the resistors should be used for any given application.

#### 1) For $V_o=1.5\text{ V} - 12\text{ V}$ :

$$R_{trimdown} = \frac{511}{|\delta|} - 10.22$$

$$R_{trimup} = \frac{(100 + \delta) \cdot V_o \cdot 5.11 - 626}{1.225 \cdot \delta} - 10.22$$

**Note:**

$$\delta = \frac{(V_{o\_req} - V_o)}{V_o} \times 100[\%]$$

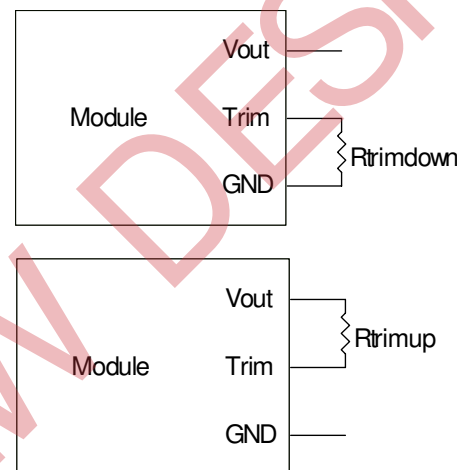

$V_{o\_req}$ =Desired (trimmed) output voltage [V];  $V_o$ =output voltage  
 $V_o=12.004\text{ V}$  for 12 V output;  $V_o=5\text{ V}$  for 5.004 V output;  $V_o=3.308\text{ V}$  for 3.3 V output;  $V_o=2.503\text{ V}$  for 2.5 V output;  $V_o=1.808\text{ V}$  for 1.8 V output;  $V_o=1.503\text{ V}$  for 1.5 V output

#### 2) For $V_o=1.2\text{ V}$ :

$$R_{trimdown} = \frac{511}{|\delta|} - 10.22$$

$$R_{trimup} = \frac{(100 + \delta) \cdot V_o \cdot 5.11 - 313}{0.6125 \cdot \delta} - 10.22$$

**Note:**

$$\delta = \frac{(V_{o\_req} - V_o)}{V_o} \times 100[\%]$$

$V_{o\_req}$ =Desired (trimmed) output voltage [V];  $V_o$ =output voltage  
 $V_o=1.202\text{ V}$  for 1.2 V output

# ISOLATED DC/DC CONVERTERS

48 Vdc Input 12 Vdc/12 A, 3.3 Vdc/46 A, 5 Vdc/30 A, 1.2-2.5 Vdc/50 A Outputs



## Efficiency Data

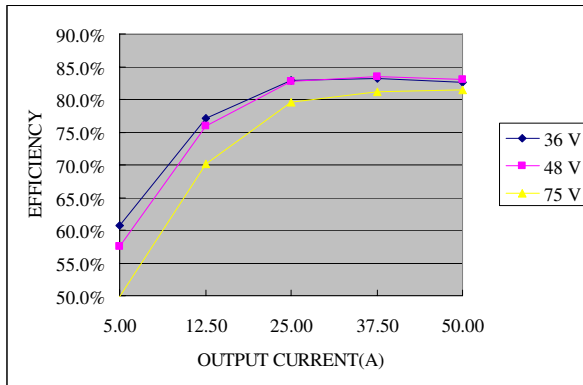

0RQB-C5TV2x

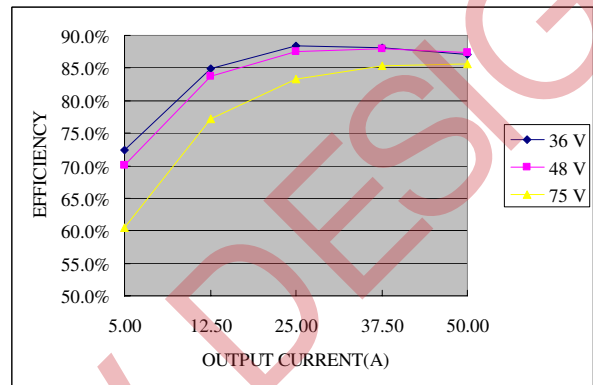

0RQB-C5TV5x

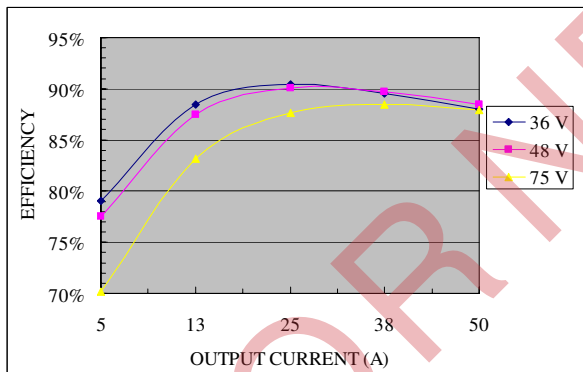

0RQB-C5TV8x

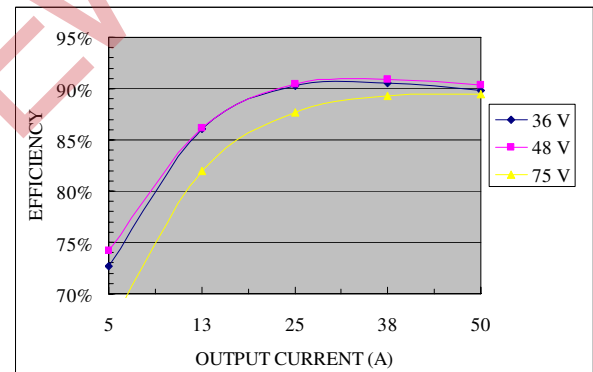

0RQB-C5T02x

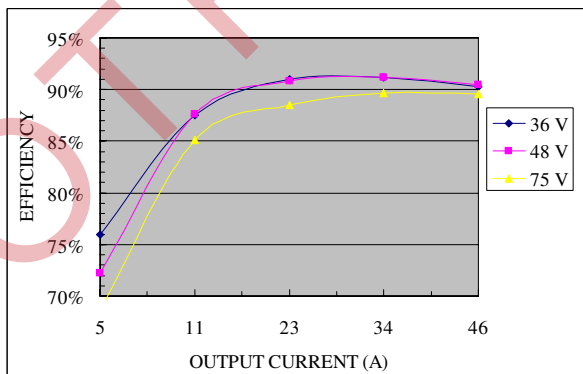

0RQB-C5T03x

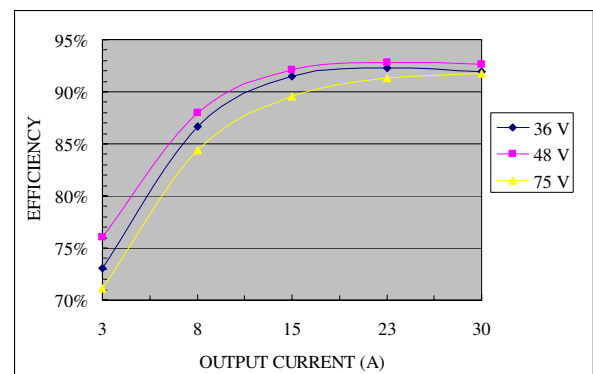

0RQB-C5T05x

# ISOLATED DC/DC CONVERTERS

48 Vdc Input 12 Vdc/12 A, 3.3 Vdc/46 A, 5 Vdc/30 A, 1.2-2.5 Vdc/50 A Outputs



## Efficiency Data (continued)

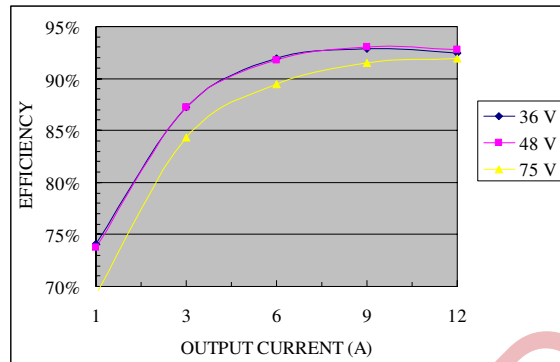

0RQB-C5T12x

## Thermal Derating Curves

Vin=48V, with maximum junction temperature of semiconductors derated to 120 degree C.

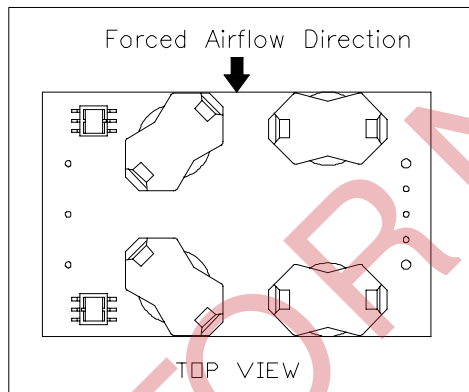

0RQB-C5Txxx

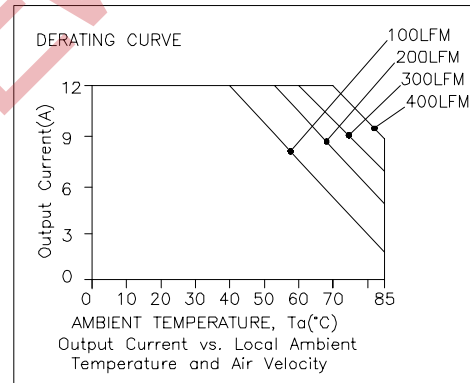

0RQB-C5T12x

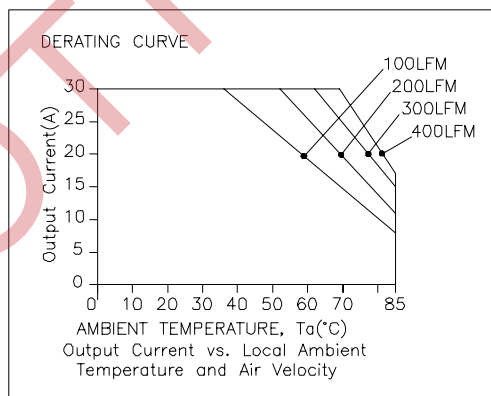

0RQB-C5T05x

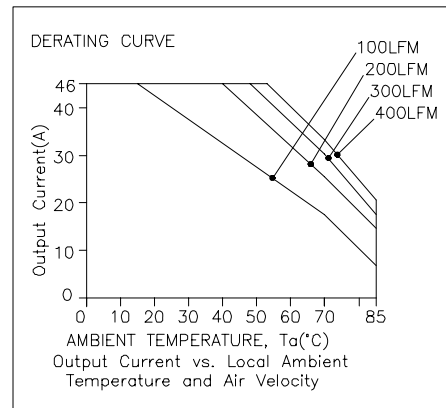

0RQB-C5T03x

# ISOLATED DC/DC CONVERTERS

48 Vdc Input 12 Vdc/12 A, 3.3 Vdc/46 A, 5 Vdc/30 A, 1.2-2.5 Vdc/50 A Outputs



## Thermal Derating Curves (continued)

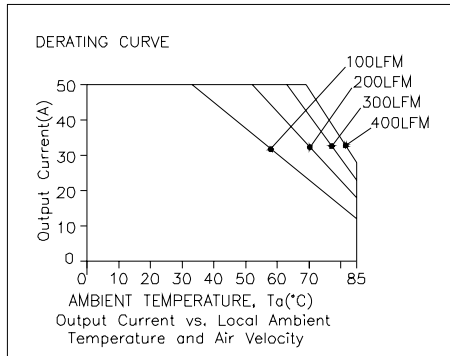

0RQB-C5T02x

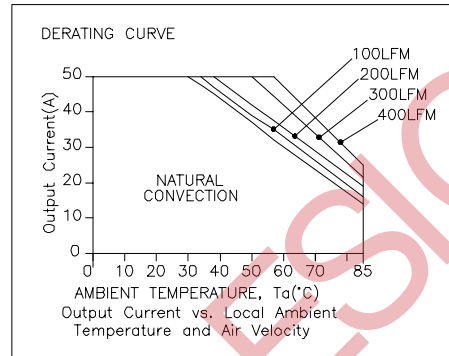

0RQB-C5TV8x

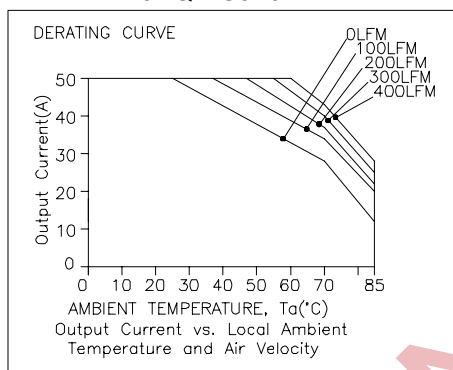

0RQB-C5TV5x

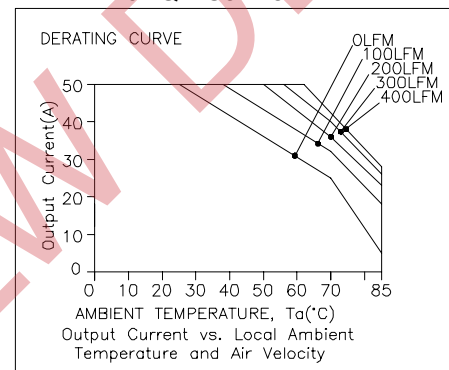

0RQB-C5TV2x

## Thermal Reference

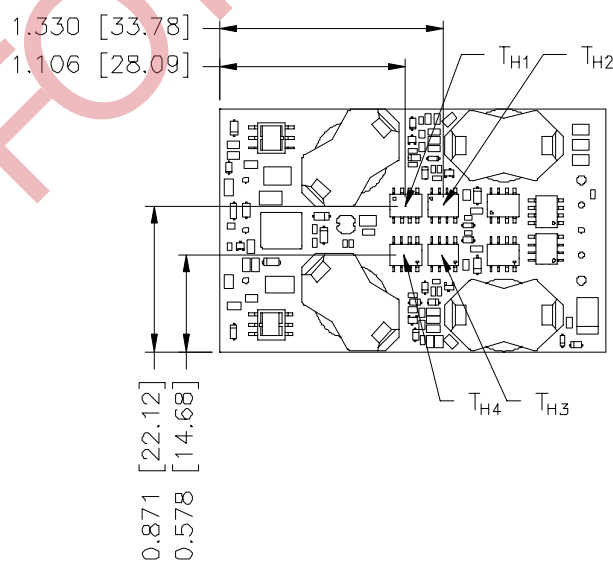

**Note:** T<sub>H1</sub>, T<sub>H2</sub>, T<sub>H3</sub> and T<sub>H4</sub> are hot spots which should not exceed 115 degree C.



# ISOLATED DC/DC CONVERTERS

48 Vdc Input 12 Vdc/12 A, 3.3 Vdc/46 A, 5 Vdc/30 A, 1.2-2.5 Vdc/50 A Outputs



## Ripple and Noise Waveforms

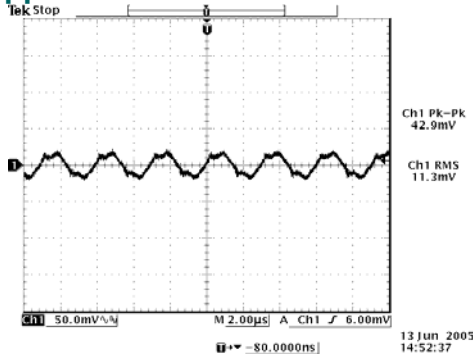

Ripple and noise at full load, 1.2 V/50 A output

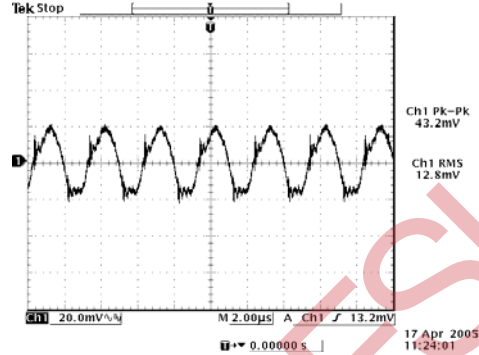

Ripple and noise at full load, 1.5 V/50 A output

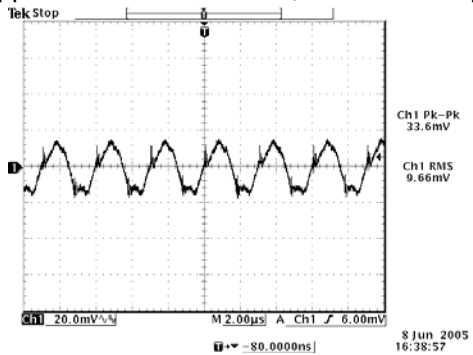

Ripple and noise at full load, 1.8 V/50 A output

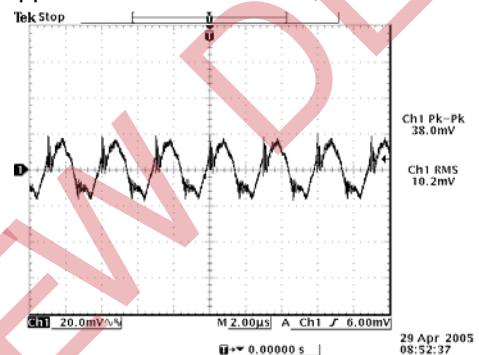

Ripple and noise at full load, 2.5 V/45 A output

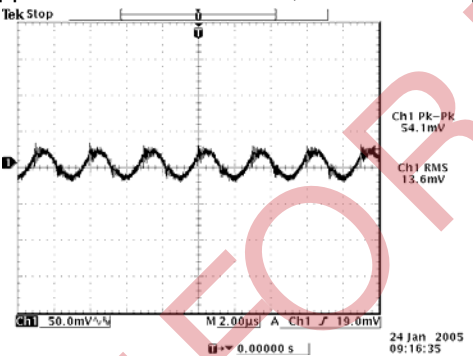

Ripple and noise at full load, 3.3 V/46 A output

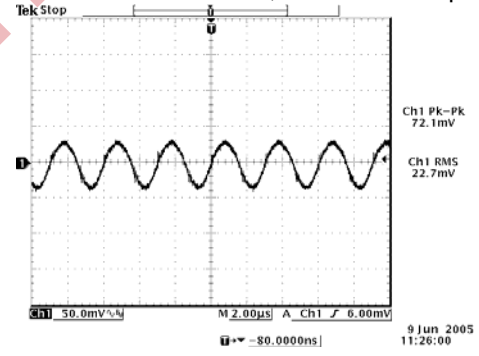

Ripple and noise at full load, 5.0 V/30 A output

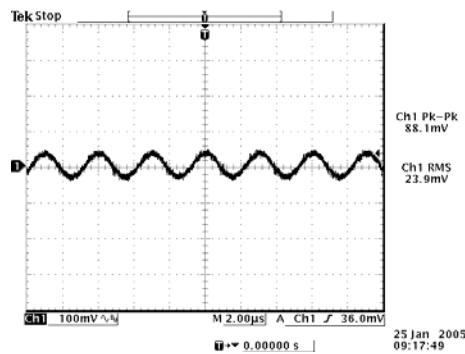

Ripple and noise at full load, 12 V/12 A output

**Note:** Ripple and noise is tested with a 1  $\mu$ F ceramic cap and a 10  $\mu$ F tantalum capat output,  $T_a=25$  deg C.

# ISOLATED DC/DC CONVERTERS

48 Vdc Input 12 Vdc/12 A, 3.3 Vdc/46 A, 5 Vdc/30 A, 1.2-2.5 Vdc/50 A Outputs



## Transient Response Waveforms

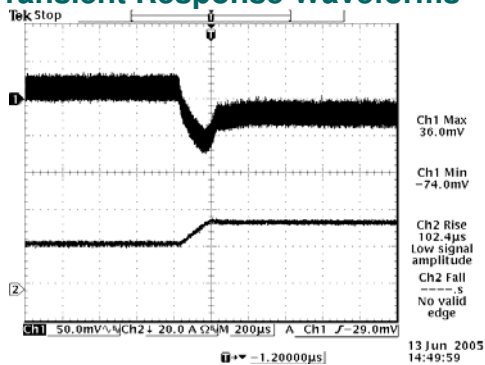

Vout= 1.2 V 50%-75% Load Transients

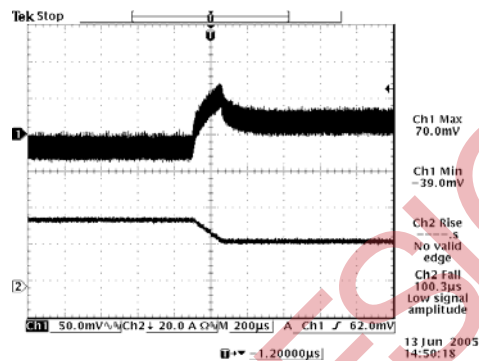

Vout= 1.2 V 75%-50% Load Transients

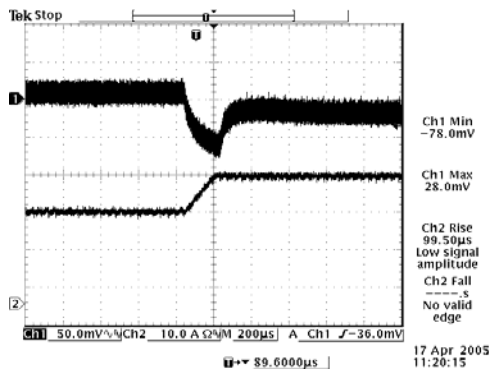

Vout= 1.5 V 50%-75% Load Transients

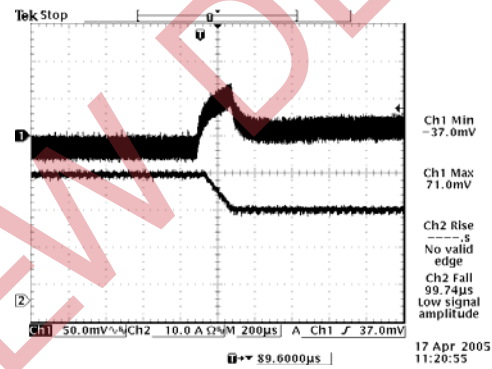

Vout= 1.5 V 75%-50% Load Transients

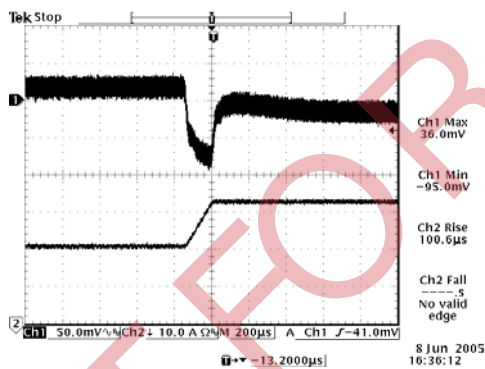

Vout= 1.8 V 50%-75% Load Transients

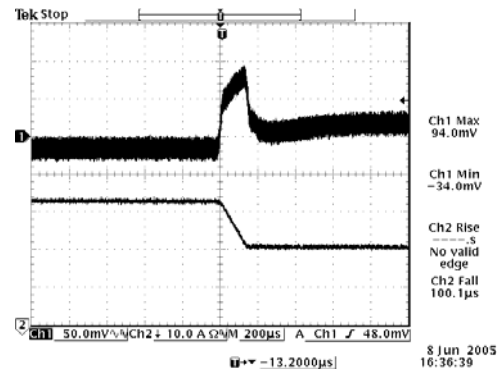

Vout= 1.8 V 75%-50% Load Transients

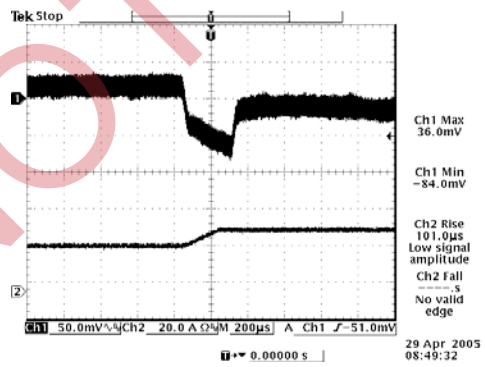

Vout= 2.5 V 50%-75% Load Transients

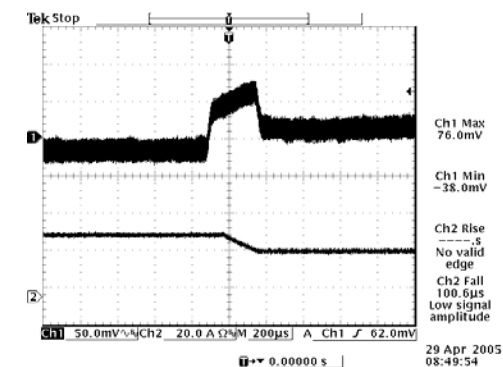

Vout= 2.5 V 75%-50% Load Transients

# ISOLATED DC/DC CONVERTERS

48 Vdc Input 12 Vdc/12 A, 3.3 Vdc/46 A, 5 Vdc/30 A, 1.2-2.5 Vdc/50 A Outputs



## Transient Response Waveforms (continued)

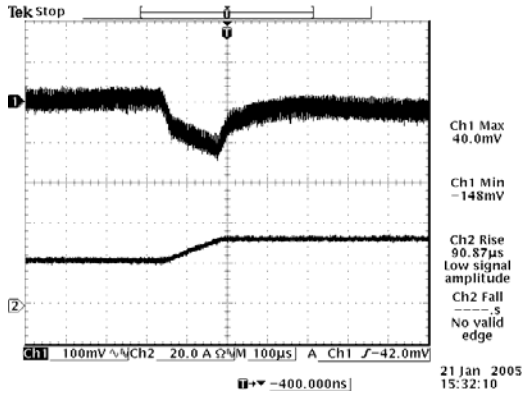

Vout= 3.3 V 50%-75% Load Transients

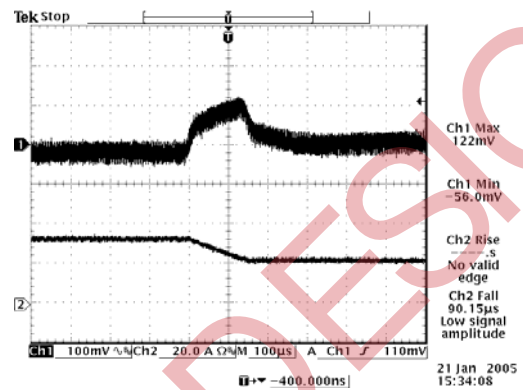

Vout= 3.3 V 75%-50% Load Transients

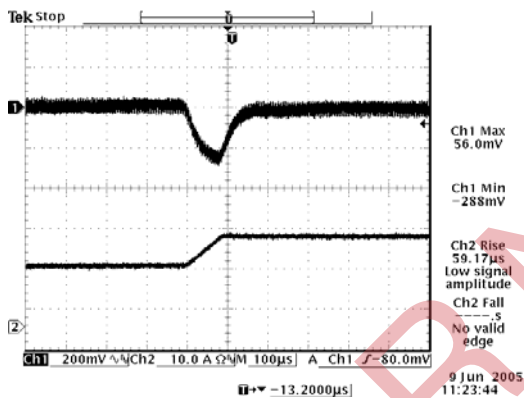

Vout= 5.0 V 50%-75% Load Transients

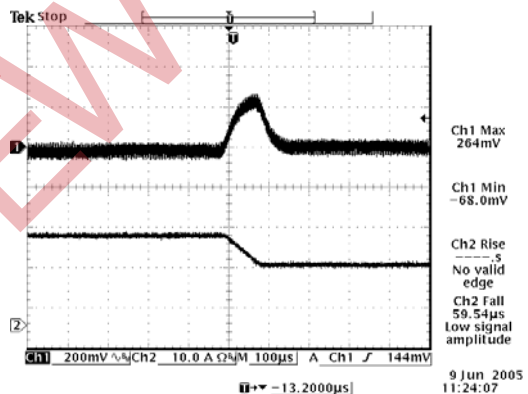

Vout= 5.0 V 75%-50% Load Transients

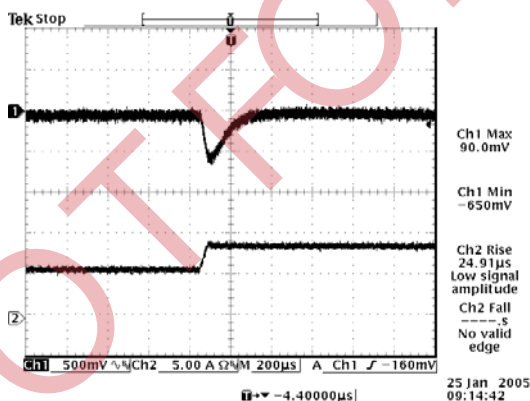

Vout= 12 V 50%-75% Load Transients

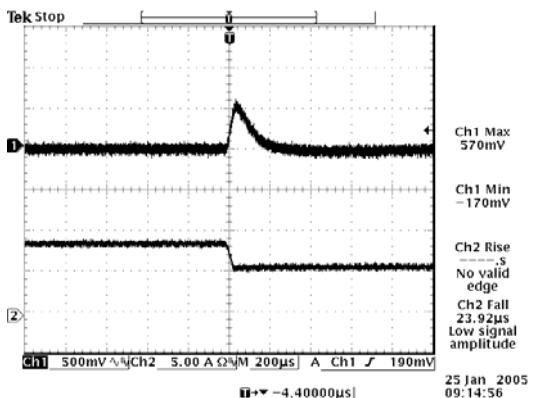

Vout= 12 V 75%-50% Load Transients

**Note:** Transient response at Vin=48 V, di/dt = 0.1 A/uS, with a 1 uF ceramic capacitor and a 10 uF Tantalum capacitor at the output, Ta=25 deg C.

# ISOLATED DC/DC CONVERTERS

48 Vdc Input 12 Vdc/12 A, 3.3 Vdc/46 A, 5 Vdc/30 A, 1.2-2.5 Vdc/50 A utputs



## Mechanical Outline

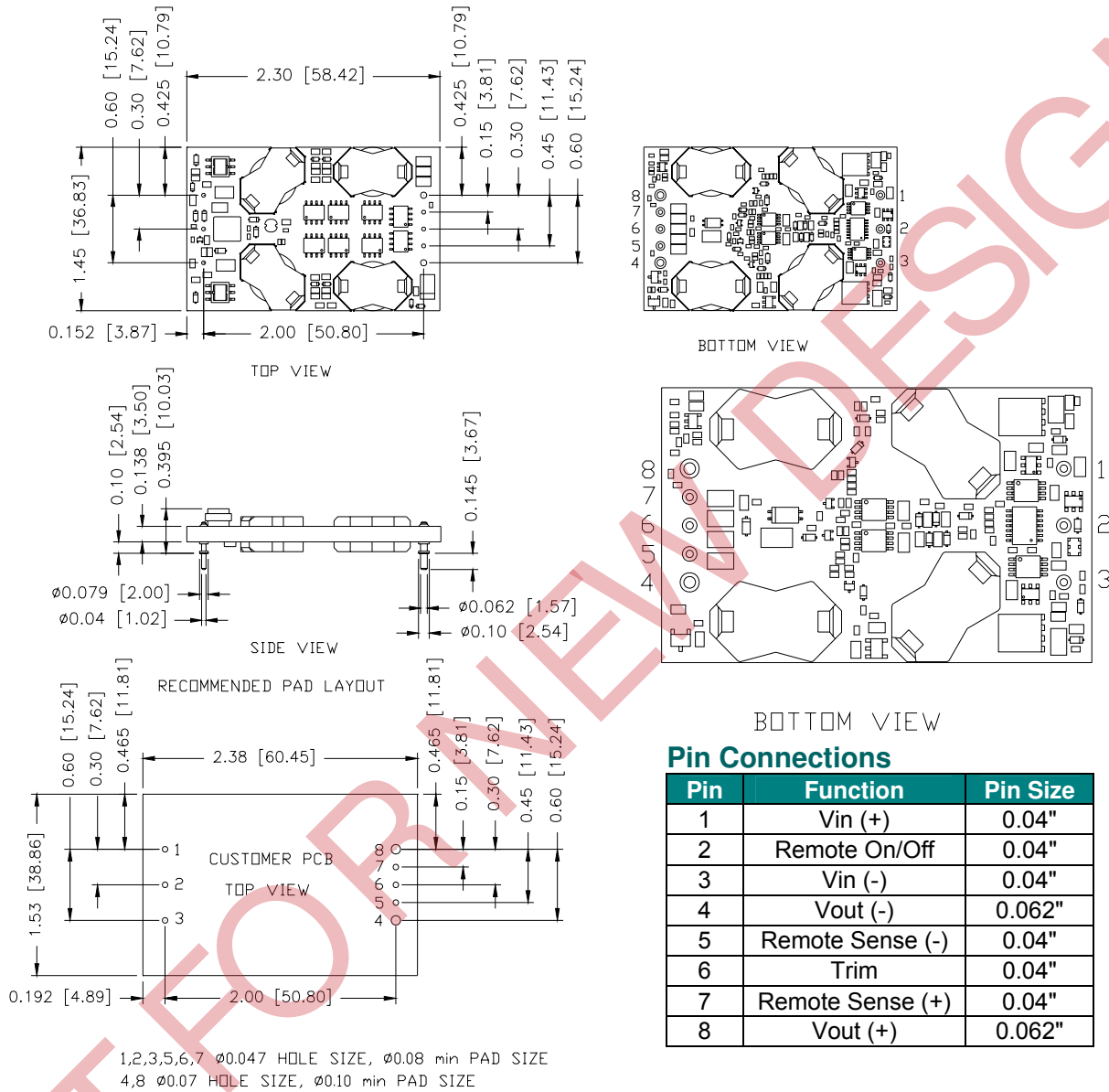

## Pin Connections

Pin	Function	Pin Size
1	Vin (+)	0.04"
2	Remote On/Off	0.04"
3	Vin (-)	0.04"
4	Vout (-)	0.062"
5	Remote Sense (-)	0.04"
6	Trim	0.04"
7	Remote Sense (+)	0.04"
8	Vout (+)	0.062"

## RoHS Compliance

Complies with the European Directive 2002/95/EC, calling for the elimination of lead and other hazardous substances from electronic products.



©2008 Bel Fuse Inc. Specifications subject to change without notice. 012508

### CORPORATE

**Bel Fuse Inc.**  
 206 Van Vorst Street  
 Jersey City, NJ 07302  
 Tel 201-432-0463  
 Fax 201-432-9542  
[www.belfuse.com](http://www.belfuse.com)

### FAR EAST

**Bel Fuse Ltd.**  
 8F/ 8 Luk Hop Street  
 San Po Kong  
 Kowloon, Hong Kong  
 Tel 852-2328-5515  
 Fax 852-2352-3706  
[www.belfuse.com](http://www.belfuse.com)

### EUROPE

**Bel Fuse Europe Ltd.**  
 Preston Technology Management Centre  
 Marsh Lane, Suite G7, Preston  
 Lancashire, PR1 8UD, U.K.  
 Tel 44-1772-556601  
 Fax 44-1772-888366  
[www.belfuse.com](http://www.belfuse.com)