

## Electronic housing - ME 22,5 F-UT BUS/ 5 KMGY - 2890771

Please be informed that the data shown in this PDF Document is generated from our Online Catalog. Please find the complete data in the user's documentation. Our General Terms of Use for Downloads are valid (<http://download.phoenixcontact.com>)



### Key commercial data

Packing unit	1 1
Minimum order quantity	10 1
Weight per Piece (excluding packing)	44.36 GRM
Custom tariff number	85472000
Country of origin	Germany

### Classifications

#### eCl@ss

eCl@ss 4.0	27180401
eCl@ss 4.1	27180401
eCl@ss 5.0	27180506
eCl@ss 5.1	27180506
eCl@ss 6.0	27180802
eCl@ss 7.0	27182702
eCl@ss 8.0	27182702

#### ETIM

ETIM 3.0	EC001031
ETIM 4.0	EC001031

#### UNSPSC

UNSPSC 6.01	31261501
UNSPSC 7.0901	31261501
UNSPSC 11	31261501
UNSPSC 12.01	31261501
UNSPSC 13.2	31261501

### Approvals

Approvals

# Electronic housing - ME 22,5 F-UT BUS/ 5 KMGY - 2890771

## Approvals

Approvals

UL Recognized

---

Ex Approvals

---

Approvals submitted

---

## Approval details



## Drawings

Dimensioned drawing

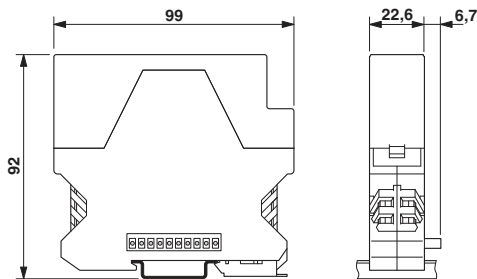

Dimensions of the electronic housing ME 22.5 flat.../BUS 5... and ME 22.5 flat.../BUS 10... with single-level upper part

Dimensioned drawing

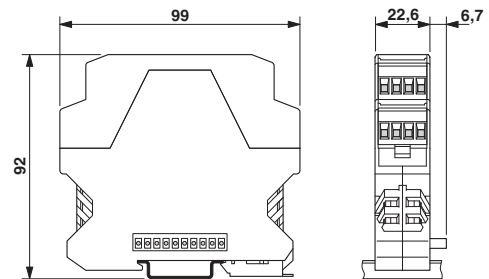

Dimensions of the electronic housing ME 22.5 flat.../BUS 5... and ME 22.5 flat.../BUS 10... with double-level upper part

# Electronic housing - ME 22,5 F-UT BUS/ 5 KMGY - 2890771

Dimensioned drawing

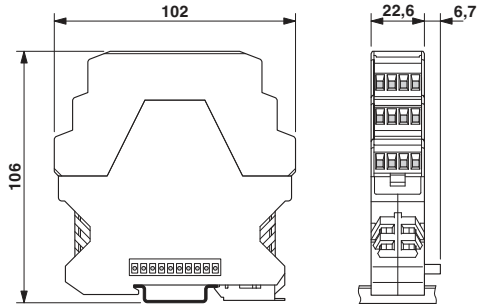

Dimensions of the electronic housing ME 22.5 flat.../BUS 5... and ME 22.5 flat.../BUS 10... with triple-level upper part

Dimensioned drawing

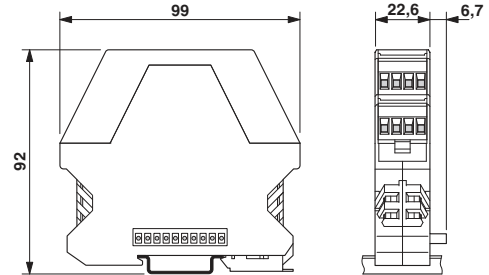

Dimensions of the electronic housing ME 22.5 flat.../BUS 5... and ME 22.5 flat.../BUS 10... with double-level upper part

Dimensioned drawing

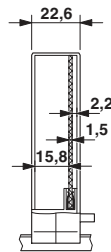

Internal housing dimensions, electronics housing ME 22.5 flat.../BUS...

# Electronic housing - ME 22,5 F-UT BUS/ 5 KMGY - 2890771

Dimensioned drawing

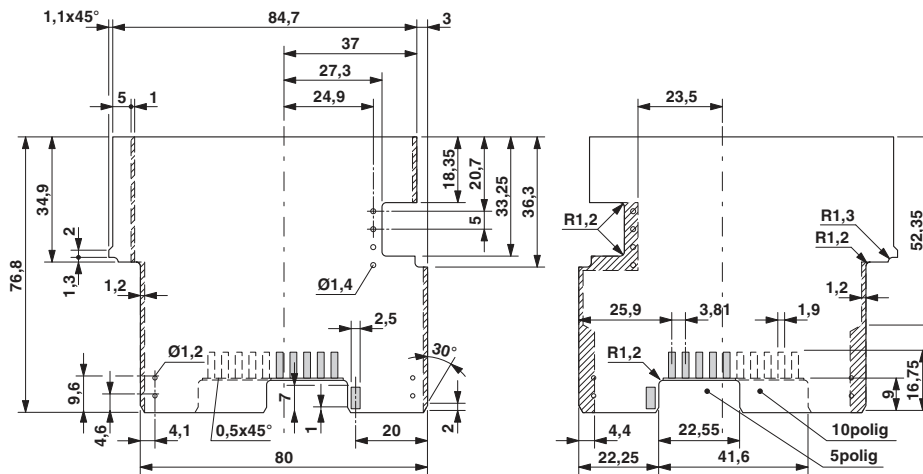

Dimensional drawing of the ME 22.5 flat.../BUS 5 and ME 22.5 flat.../BUS 10 printed circuit boards if the single-level upper part is used

Dimensioned drawing

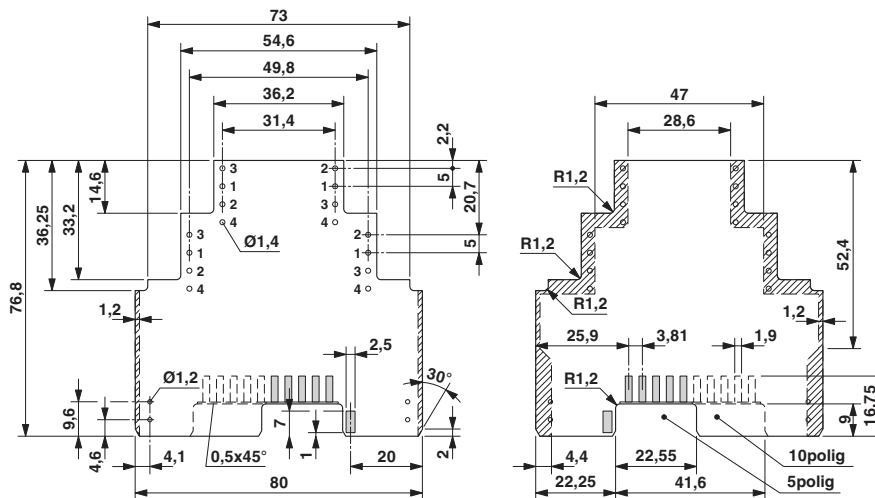

Dimensional drawing of the ME 22.5 flat.../BUS 5 and ME 22.5 flat.../BUS 10 printed circuit boards if the double-level upper part is used

# Electronic housing - ME 22,5 F-UT BUS/ 5 KMGY - 2890771

Dimensioned drawing

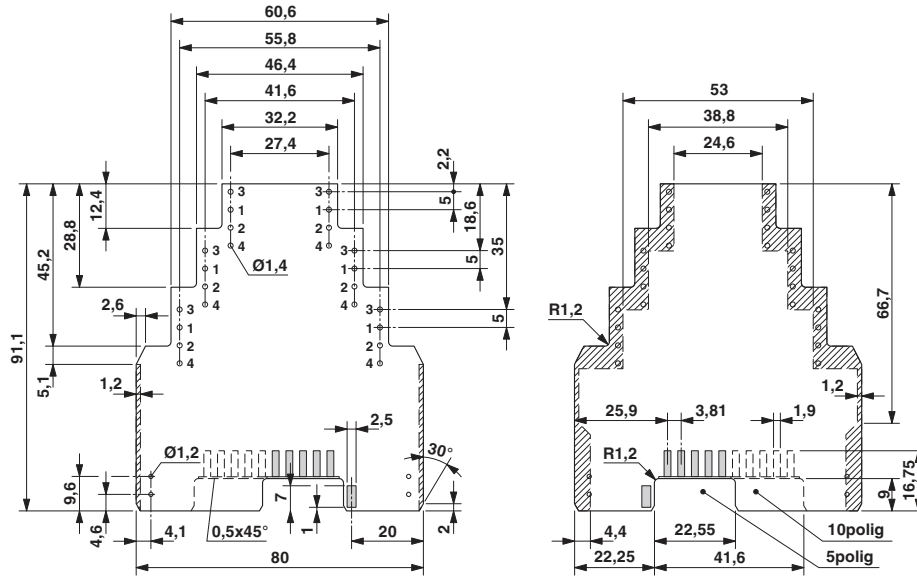

Dimensional drawing of the ME 22.5 flat.../BUS 5 and ME 22.5 flat.../BUS 10 printed circuit boards if the triple-level upper part is used