

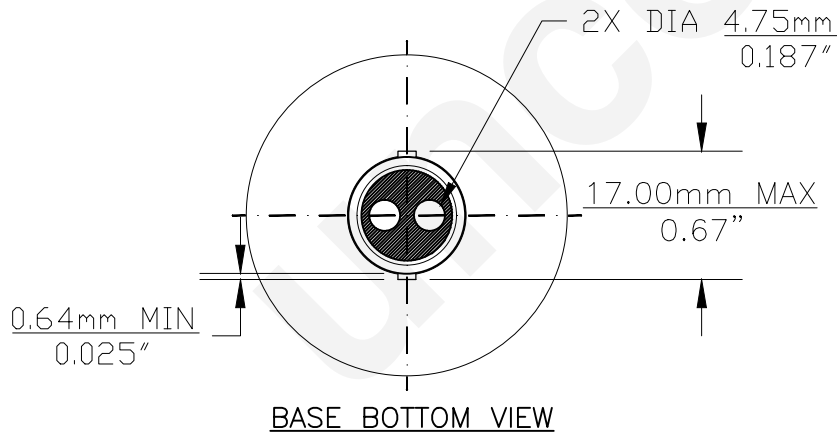

Since 1959

PART NO.	BASE TYPE	DESIGN VOLTS	DESIGN AMPS	MSCD	FILAMENT TYPE	AVERAGE LIFE HOURS	REVISIONS			
							REV #	DESCRIPTION	DATE	APPROVED
CE16	D.C. Bayonet (BA15d)	48.0V	0.83±15%	--	C-2V or CC-2V	30	1	ISSUED	11/14/2014	R.M.

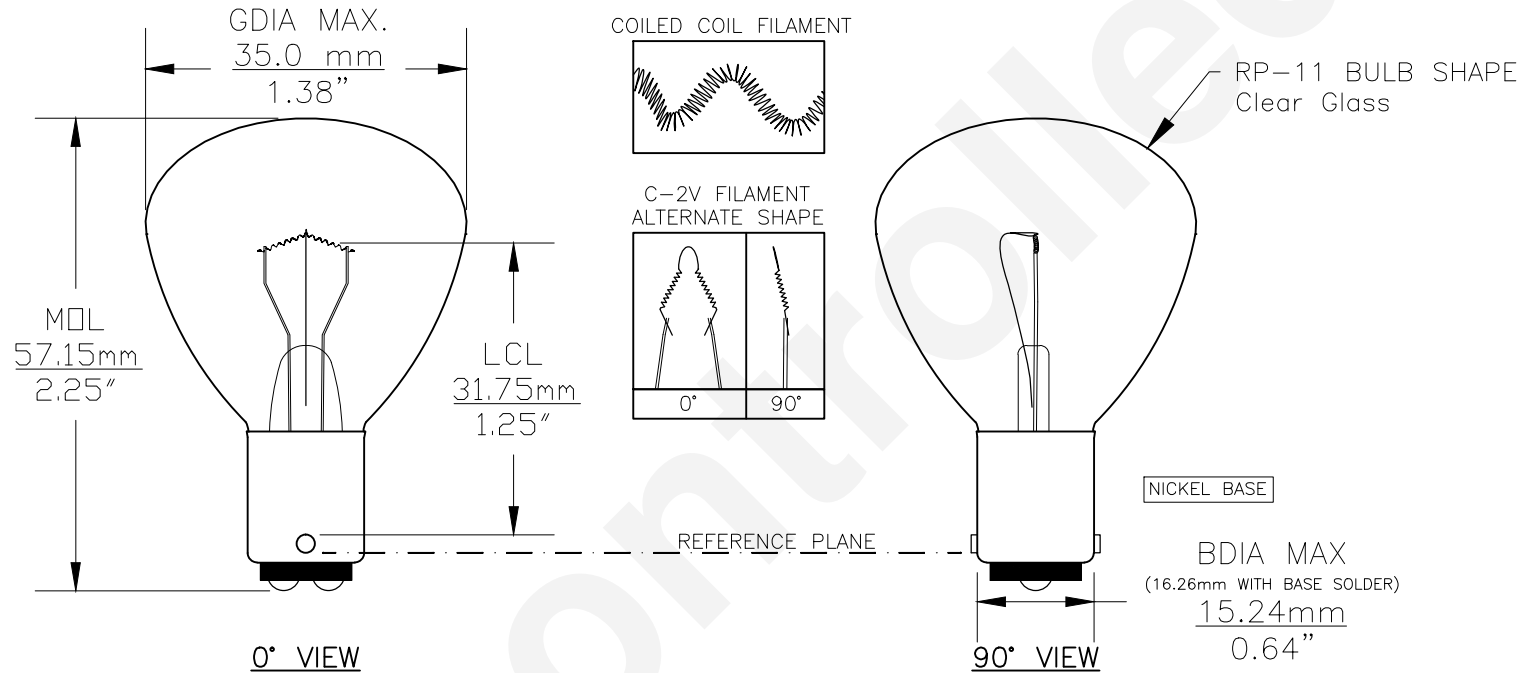

Note: Made according to SAE specifications



UNLESS OTHERWISE SPECIFIED: DIMENSIONS ARE IN INCHES TOLERANCES		CEC INDUSTRIES LTD			
DECIMALS .XX ± .05	ANGULAR ± 0.5°	599 BOND STREET		LINCOLNSHIRE, IL 60069	
.XXX ± .010	FRACTIONAL ± 1/64	TITLE LIGHT BULB NO. CE16			
DRAWN ROSE MEDINA	DATE 11/14/2014	SIZE A	FSCM NO.	DWG NO. CE16	REV 1
CHECKED	DESIGN	SCALE	PLOT SCALE	SHEET 1 OF 1	
MATERIAL	FILE CE16.pdf	DRAWING NOT TO SCALE			