



Electrical Specifications

Cutoff Frequency (Fc): 1600 MHz
Passband: 1600-3000 MHz
Passband Insertion Loss : 3.0dB Max.
Passband Return Loss: 14dB Min.
Rejection: 40 dB Min. @ 0-1400 MHz

Mechanical

Connector Type: SMA(F)
Dimensions: 1.5" x 0.75" x 0.5"

Environmental

Operating Temperature: -25°C to +70°C
Storage Temperature: -60°C to +90°C
Shock: 10 G. 11ms
Vibration: 10 G. 5 to 200Hz

Outline Drawing:

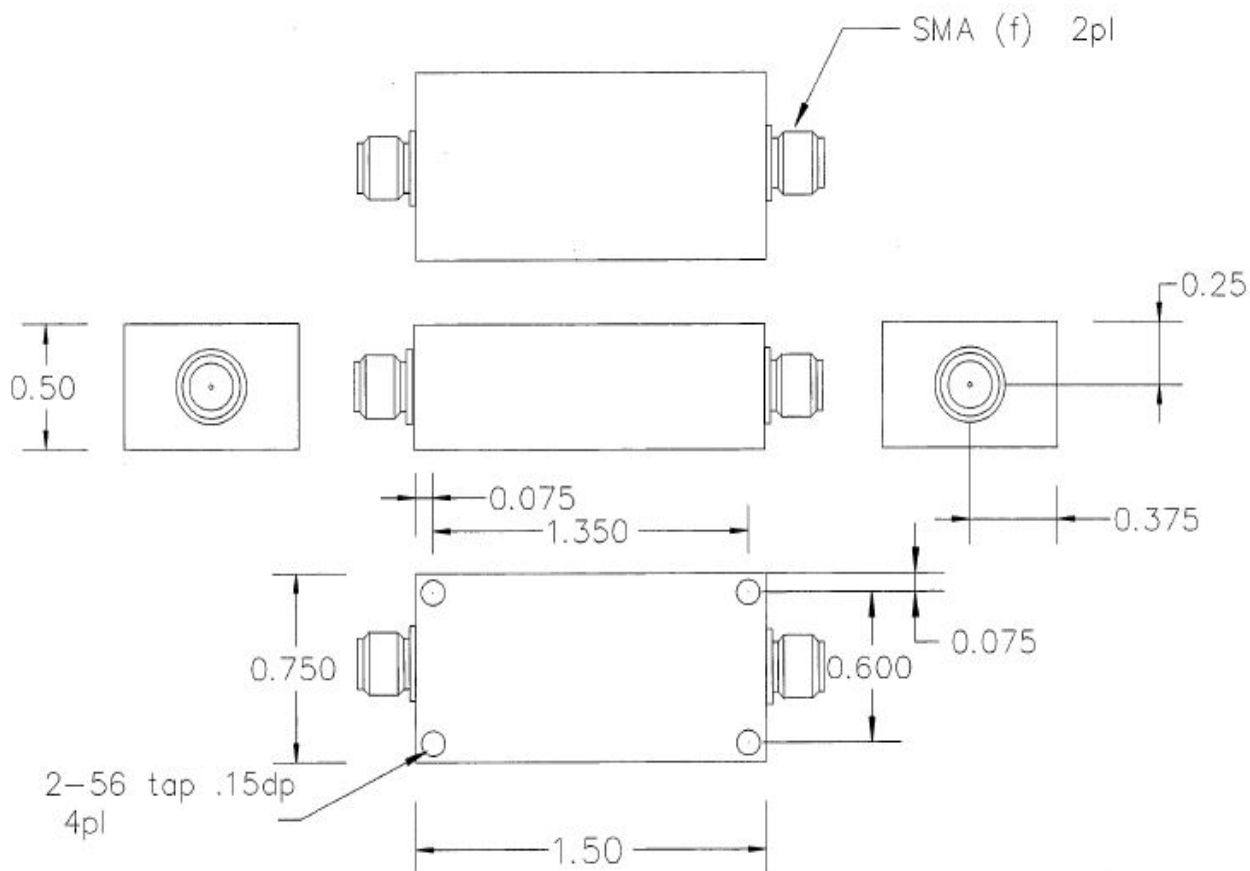



Response Plot :

