



**SPECIFICATION SHEET**

<b>SPECIFICATION SHEET NO.</b>	N0310- DFN06035D6S5BU
<b>DATE</b>	Mar. 10, 2021
<b>REVISION</b>	A0
<b>DESCRIPTION</b>	SMD Plastic-Encapsulate ESD Protection Diodes, DFN0603 series ESD05D6BU Type, Ultra Low Capacitance ESD Protection Diodes Reverse Working Voltage : 5.0V, Peak Pulse Power per: 100 Watts Operating Temp. Range -55°C ~+125°C, Package in Tape/Reel, 10,000pcs/Reel RoHS/RoHS III compliant
<b>CUSTOMER</b>	
<b>CUSTOMER PART NUMBER</b>	
<b>CROSS REF. PART NUMBER</b>	
<b>ORIGINAL PART NUMBER</b>	MDD ESD05D6BU
<b>PART CODE</b>	DFN06035D6S5BU

<b>VENDOR APPROVE</b>			
Issued/Checked/Approved			
DATE: March 10, 2021			

<b>CUSTOMER APPROVE</b>	
DATE:	

**SMD ESD PROTECTION DIODES (TUBE) DFN0603 SERIES**

**MAIN FEATURE**

- Peak Power Dissipation: 100 W (8/20µs)
- IEC61000-4-2 (ESD) ±15kV (air), ±8kV (contact)
- IEC61000-4-4 (EFT) 40A (5/50ns)
- Package optimized for high-speed lines
- Working Voltage: 5V
- Cable Discharge Event(CDE)
- Low clamping voltage
- Low leakage current
- Low Capacitance :0.25pF Typical



**APPLICATION**

- Serial ATA
- Desktops, Servers and Notebooks
- Cellular Phone
- MDDI Ports
- Display Ports
- USB Data Line Protection
- Digital Visual Interface (DVI)

**[RFQ](#)**

[Request For Quotation](#)

**PART CODE GUIDE**

DFN0603	5D6	S	5BU
1	2	3	4

- 1) **DFN0603**: SMD Plastic-Encapsulate ESD Protection Diodes, DFN1006 series, 2 pads
- 2) **5D6**: Type code for original part number ESD05D6BU
- 3) **S**: Package code, Package in Tape/Reel, 10,000pcs/Reel
- 4) **5BU**: Marking code “5BU” on the case surface, Different Marking for different specification.

**MORE ITEMS AVAILABLE**

DFN06035D6S5BU	DFN06033D6S3BU	DFN06035D6S00Y		

**SMD ESD PROTECTION DIODES (TUBE) DFN0603 SERIES**

**DIMENSION (Unit: Inch/mm)**

Image for reference



Marking: 5BU

DFN0603

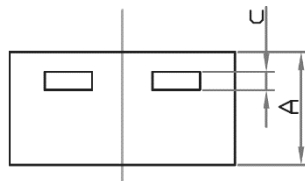
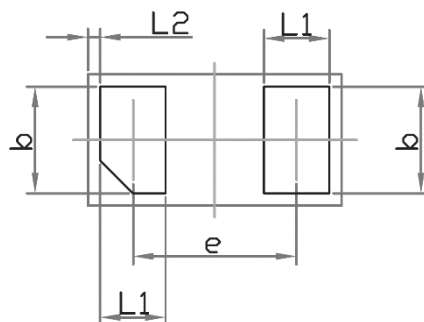
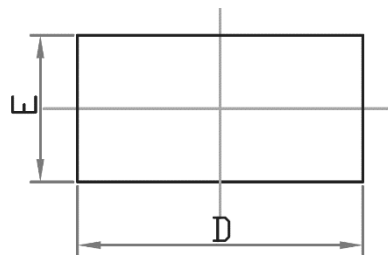

Symbol	Value ( mm )		
	Min.	Typ.	Max.
A	0.275	-	0.340
D	0.570		0.670
E	0.270		0.370
b	0.225		0.295
c	-	0.05	-
e	0.365		0.435
L1	0.125		0.195
L2		0.03	

**Recommend Pad Layout**

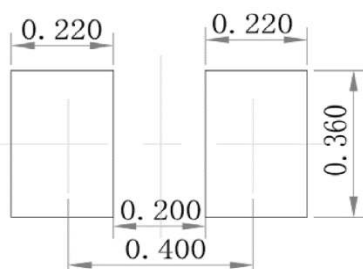

**Pin Configuration**

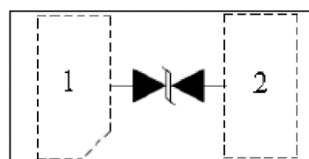

**Circuit Diagram**



**SMD ESD PROTECTION DIODES (TUBE) DFN0603 SERIES**
**MECHANICAL DATA**

Case	Terminals	Flammability Rating	Marking	Weight per piece
JEDEC DFN0603 molded plastic body	Gold plated, solderable per MIL-STD-750, method 2026	UL 94V-0	5BU	0.00019 Ounce, 0.00591 grams

**ABSOLUTE MAX. RATINGS AT Ta=25 °C (unless otherwise specified)**

Parameter	SYMBOLS	VALUE	UNITS
		LIMIT	
ESD per IEC 61000-4-2 (Air)	V ESD	+/-20	KV
ESD per IEC 61000-4-2 (Contact)	V ESD	+/-20	KV
Peak Pulse Power( tp=8/20us waveform)	P PP	100	W
Lead Solder Temperature – Maximum (10 Second Duration)	T L	260(10 sec.)	°C
Operating Temperature Range	TOPT	-55 ~+ 125	°C
Storage Temperature Range	T STG	-55 ~ +150	°C

**ABSOLUTE MAX. RATINGS AT Ta=25 °C (unless otherwise specified)**

Parameter	SYMBOLS	VALUE			UNITS
		Min.	Typical	Max.	
Reverse Working Voltage	V RWM			5.0	V
Reverse Breakdown Voltage @ I <sub>T</sub> = 1.0mA	V BR	6.0			V
Reverse Leakage Current @V <sub>RWM</sub> = 5.0V	I R			100	nA
Clamping Voltage @ I <sub>PP</sub> = 1A, t <sub>p</sub> = 8/20μs	V C			13	V
Clamping Voltage @ I <sub>PP</sub> = 4A, t <sub>p</sub> = 8/20μs	V C			25	V
Junction Capacitance VR = 0V, f = 1MHz	C J		0.25	-	pF

Note:  
The above data are for reference only.

**SMD ESD PROTECTION DIODES (TUBE) DFN0603 SERIES**
**RELIABILITY**

Number	Experiment Items	Experiment Method And Conditions	Reference Documents
1	Solder Resistance Test	Test 260°C± 5°C for 10 ± 2 sec. Immerse body into solder 1/16" ± 1/32"	MIL-STD-750D METHOD-2031.2
2	Solderability Test	230°C ±5°C for 5 sec.	MIL-STD-750D METHOD-2026.1 0
3	Pull Test	1 kg in axial lead direction for 10 sec.	MIL-STD-750D METHOD-2036.4
4	Bend Test	0.5Kg Weight Applied To Each Lead, Bending Arcs 90 °C ± 5 °C For 3 Times	MIL-STD-750D METHOD-2036.4
5	High Temperature Reverse Bias Test	TA=100°C for 1000 Hours at VR=80% Rated VR	MIL-STD-750D METHOD-1038.4
6	Forward Operation Life Test	TA=25°C Rated Average Rectified Current	MIL-STD-750D METHOD-1027.3
7	Intermittent Operation Life Test	On state: 5 min with rated IRMS Power Off state: 5 min with Cool Forced Air. On and off for 1000 cycles.	MIL-STD-750D METHOD-1036.3
8	Pressure Cooker Test	15 PSIG, TA=121°C, 4 hours	MIL-S-19500 APPENOIXC
9	Temperature Cycling Test	-55°C~+125°C; 30 Minutes For Dwelled Time 5 minutes for transferred time. Total: 10 cycles.	MIL-STD-750D METHOD-1051.7
10	Thermal Shock Test	0°C for 5 minutes., 100°C for 5minutes, Total: 10 cycles	MIL-STD-750D METHOD-1056.7
11	Forward Surge Test	8.3ms Single Sale Sine-wave One Surge.	MIL-STD-750D METHOD-4066.4
12	Humidity Test	TA=65°C, RH=98% for 1000 hours.	MIL-STD-750D METHOD-1021.3
13	High Temperature Storage life Test	150°C for 1000 Hours	MIL-STD-750D METHOD-1031.5

**SMD ESD PROTECTION DIODES (TUBE) DFN0603 SERIES**

**SUGGESTED REFLOW PROFILE (For Reference Only)**

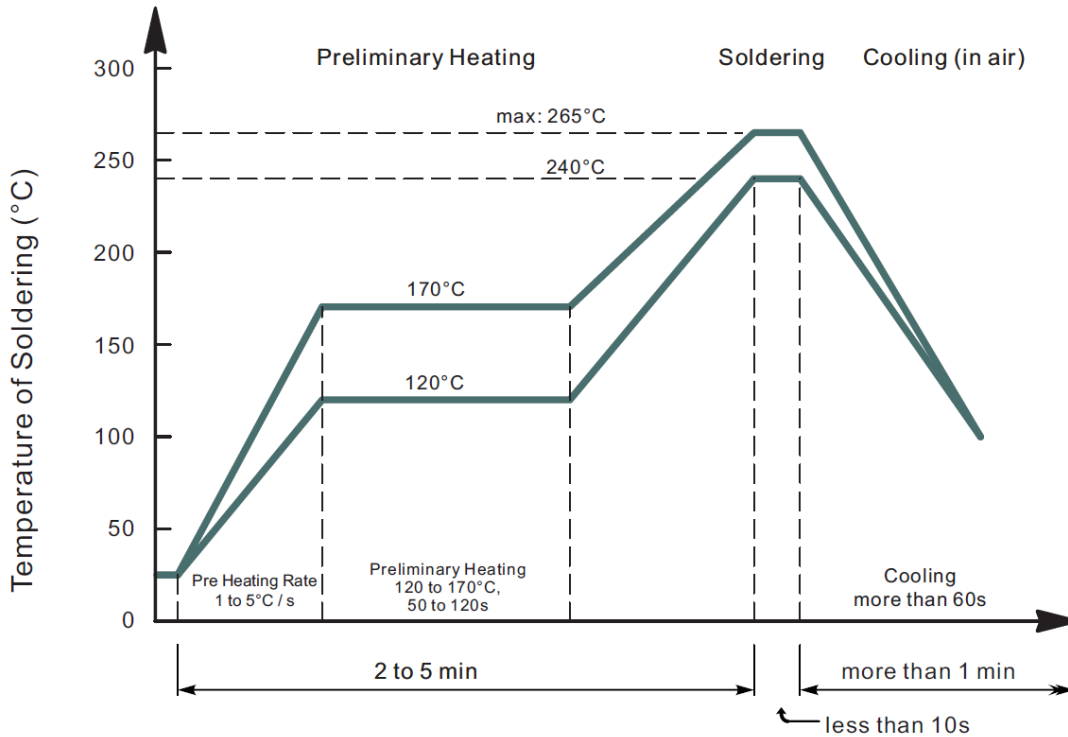

- Recommended peak temperature is over 245°C, If peak temperature is below 245 °C, you may adjust the following parameters; time length of peak temperature (longer), time length of soldering (longer), thickness of solder paste (thicker)
- Welding shall not exceed 2 times
- Remark: lead free solder paste (96.5 sn/3.0 Ag/0.5Cu)

**SMD ESD PROTECTION DIODES (TUBE) DFN0603 SERIES**

**RATINGS AND CHARACTERISTIC CURVES (For Reference Only)**

**Fig 1 Power Derating Curve**

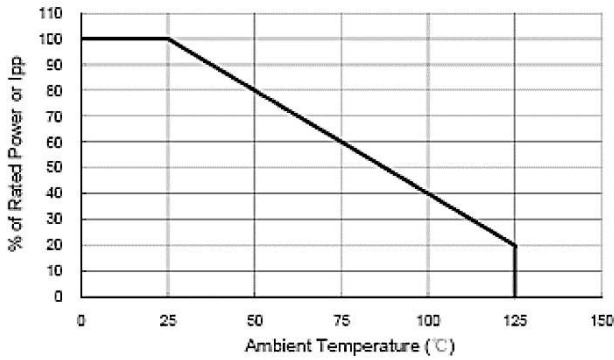

**Fig 2 Clamping Voltage vs Peak Pulse Current**

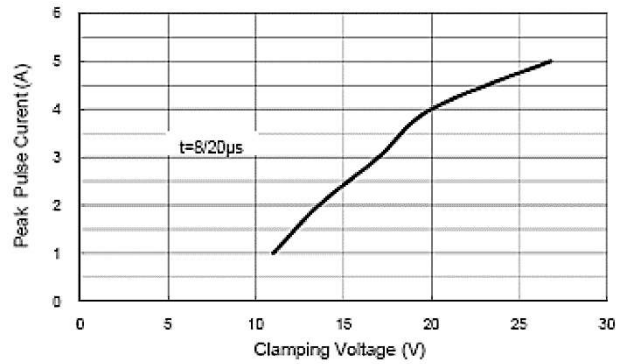

**Fig 3 Voltage Sweeping**

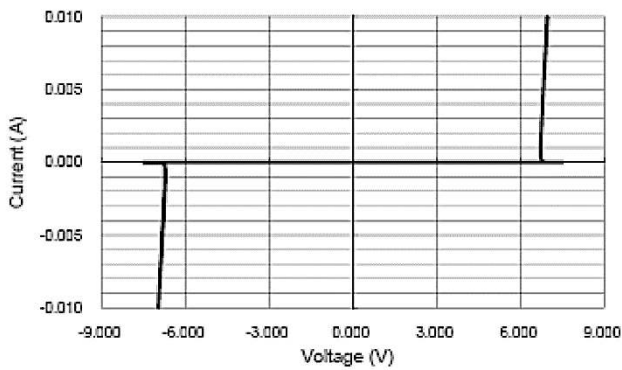

**Fig 4 Voltage vs Capacitance**

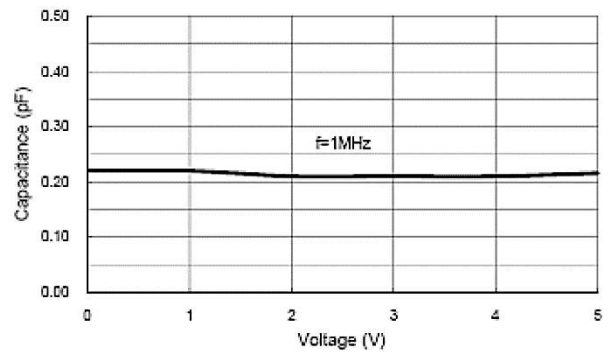

**Fig 5 ESD Clamping (+8kV Contact per IEC 61000-4-2)**

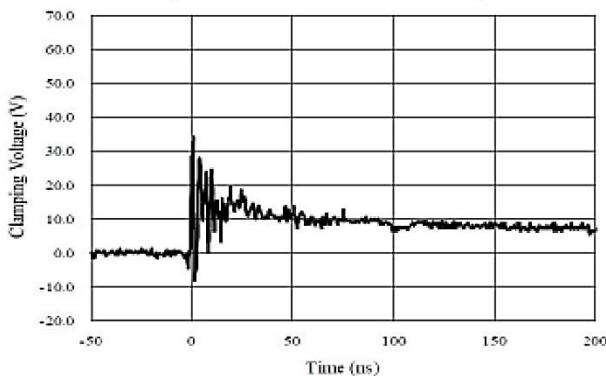

**Fig 6 ESD Clamping (-8kV Contact per IEC 61000-4-2)**

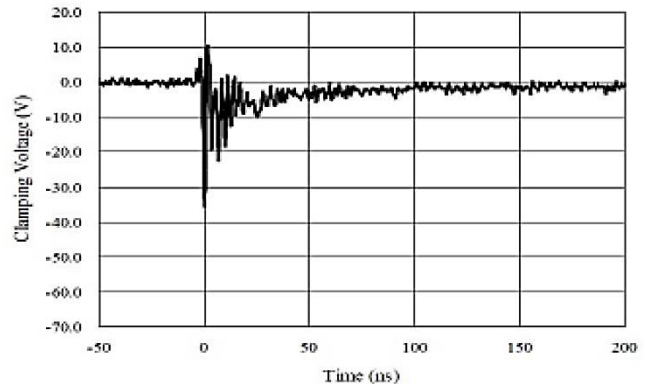

**SMD ESD PROTECTION DIODES (TUBE) DFN0603 SERIES**

**TAPE/REEL (Unit: mm)**

All Devices are packed in accordance with EIA standard RS-481-A and specifications.

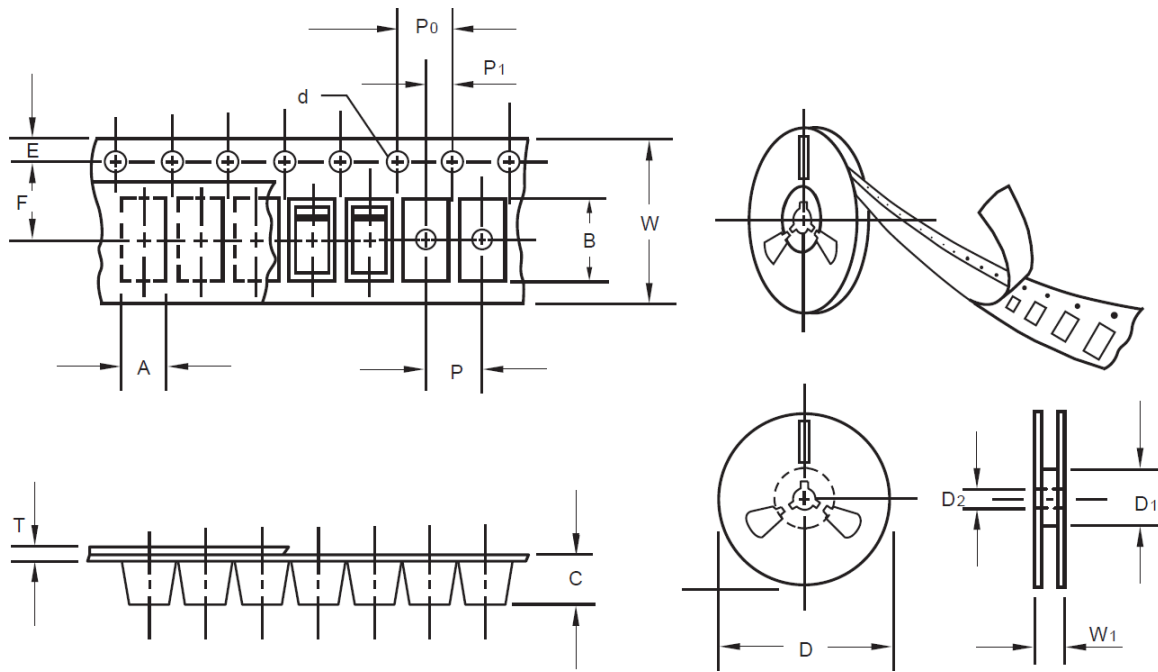

Item	Symbol	Tolerance	DFN0603
Carrier width	A	0.1	2.10
Carrier Length	B	0.1	4.00
Carrier Depth	C	0.1	1.60
Sprocket hole	d	0.05	1.55
13"Reel outside diameter	-	-	-
13"Reel inner diameter	-	-	-
7"Reel outside diameter	D	2.0	178.00
7"Reel inner diameter	D1	Min.	50.00
Feed hole diameter	D2	0.5	13.00
Sprocket hole position	E	0.1	1.75
Punch hole position	F	0.1	3.50
Punch hole pitch	P	0.1	4.00
Sprocket hole pitch	P0	0.1	4.00
Embossment center	P1	0.1	2.00
Overall tape thickness	T	0.1	0.25
Tape width	W	0.3	8.15
Reel width	W1	1.0	10.50



**SMD ESD PROTECTION DIODES (TUBE) DFN0603 SERIES**

**PACKAGE**

Case Code	Reel Size	MPQ (pcs)	Component Spacing (mm)	Qty. Per Box (pcs)	Inner Box L*W*H (mm)	Reel Size (mm)	Carton size L*W*H (mm)	Qty. Per Carton (pcs)	G. W (kg)
DFN1006	7"	10,000		100,000	210*210*205	178	445*445*230	400,000	6.5

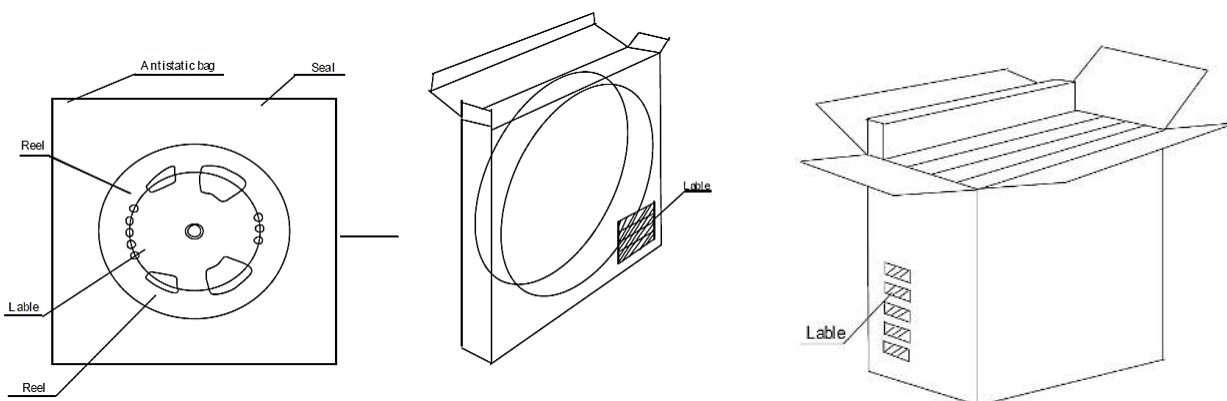

**DISCLAIMER**

NextGen Component, Inc. reserves the right to make changes to the product(s) and or information contained herein without notice. No liability is assumed as a result of their use or application. No rights under any patent accompany the sale of any such product(s) or information