

GaAs MMIC SMT VOLTAGE-VARIABLE ATTENUATOR, DC - 8 GHz



Typical Applications

This attenuator is ideal for use as a VVA for DC - 8 GHz applications:

- Point-to-Point Radio
- VSAT Radio

Features

- Wide Bandwidth: DC - 8 GHz
- Low Phase Shift vs. Attenuation
- 32 dB Attenuation Range

Functional Diagram

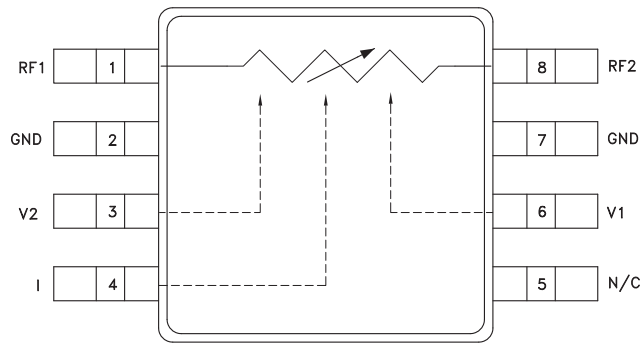

General Description

The HMC346MS8G & HMC346MS8GE are absorptive Voltage Variable Attenuators (VVA) in 8 lead surface-mount packages operating from DC - 8 GHz. It features an on-chip reference attenuator for use with an external op-amp to provide simple single voltage attenuation control, 0 to -3V. The device is ideal in designs where an analog DC control signal must control RF signal levels over a 30 dB amplitude range. Applications include AGC circuits and temperature compensation of multiple gain stages in microwave point-to-point and VSAT radios.

Electrical Specifications, $T_A = +25^\circ\text{C}$, 50 ohm system

Parameter	Min	Typical	Max	Units
Insertion Loss DC - 8 GHz		1.5	2.5	dB
Attenuation Range DC - 8 GHz	27	32		dB
Return Loss DC - 8 GHz	5	10		dB
Switching Characteristics	tRISE, tFALL (10/90% RF)	2		ns
	tON, tOFF (50% CTL to 10/90% RF)		8	ns
Input Power for 0.25 dB Compression (0.5 - 8 GHz)	Min. Atten.	+8		dBm
	Atten. >2 dB		-2	dBm
Input Third Order Intercept (0.5 - 8 GHz) (Two-tone Input Power = -8 dBm Each Tone)	Min. Atten.	+25		dBm
	Atten. >2 dB		+10	dBm



GaAs MMIC SMT VOLTAGE-VARIABLE ATTENUATOR, DC - 8 GHz

Insertion Loss vs. Temperature

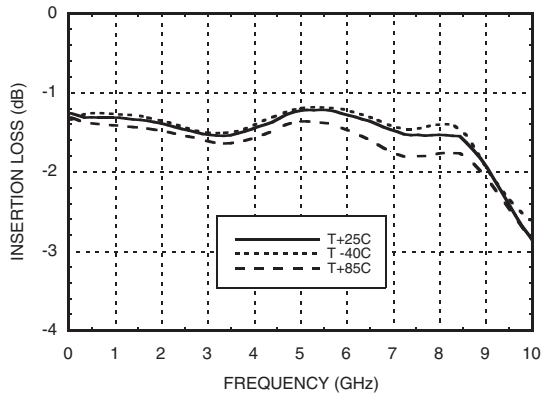

Relative Attenuation

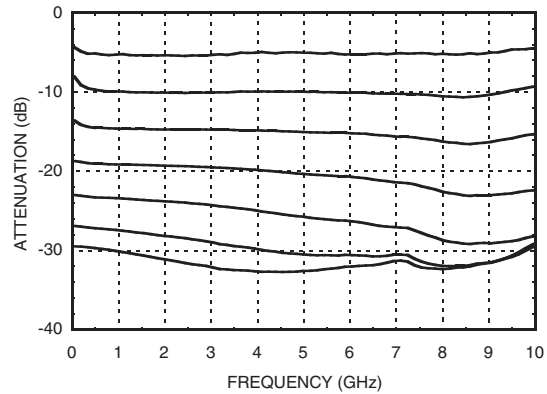

Return Loss vs. Attenuation

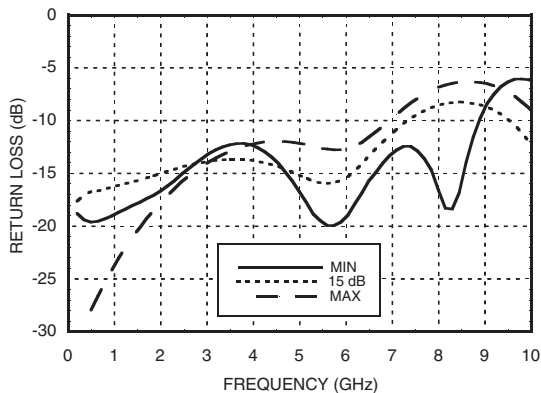

Relative Attenuation vs. Control Voltage @ 4 GHz

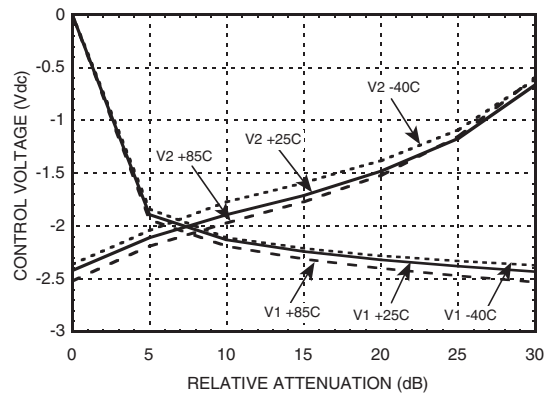

Relative Phase

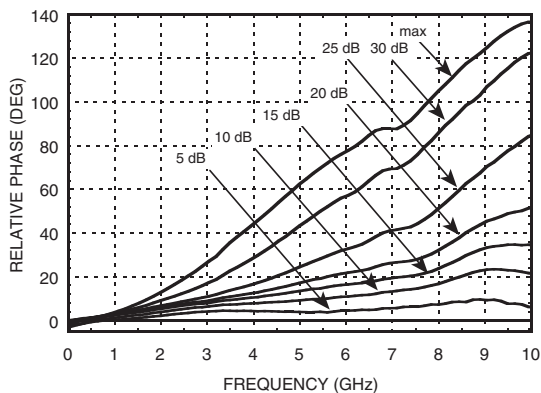

Relative Attenuation vs. Control Voltage @ 8 GHz

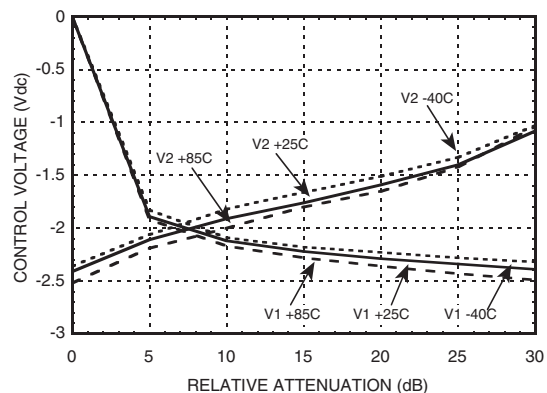

Information furnished by Analog Devices is believed to be accurate and reliable. However, no responsibility is assumed by Analog Devices for its use, nor for any infringements of patents or other rights of third parties that may result from its use. Specifications subject to change without notice. No license is granted by implication or otherwise under any patent or patent rights of Analog Devices. Trademarks and registered trademarks are the property of their respective owners.

For price, delivery, and to place orders: Analog Devices, Inc., One Technology Way, P.O. Box 9106, Norwood, MA 02062-9106 Phone: 781-329-4700 • Order online at www.analog.com Application Support: Phone: 1-800-ANALOG-D



**GaAs MMIC SMT VOLTAGE-VARIABLE
ATTENUATOR, DC - 8 GHz**

5

ATTENUATORS - SMT

Input Third Order Intercept vs Attenuation*

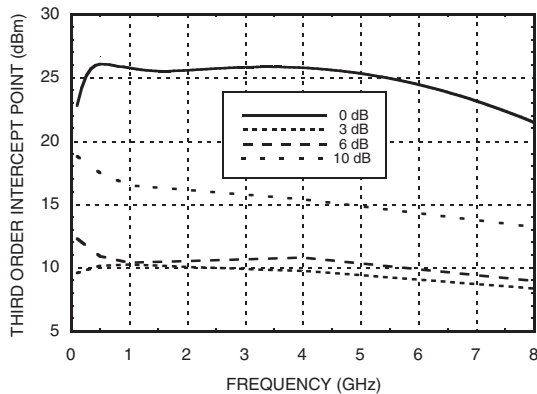

Input Second Order Intercept vs. Attenuation*

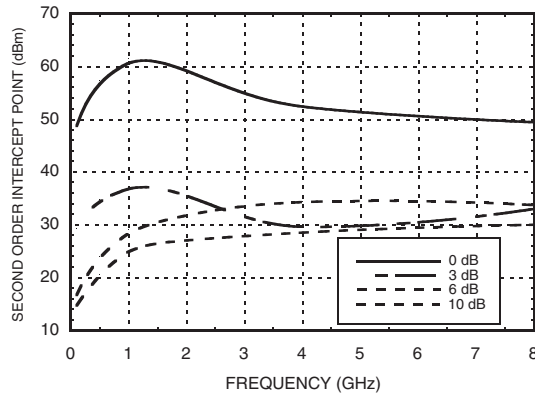

0.25 dB Compression vs. Attenuation

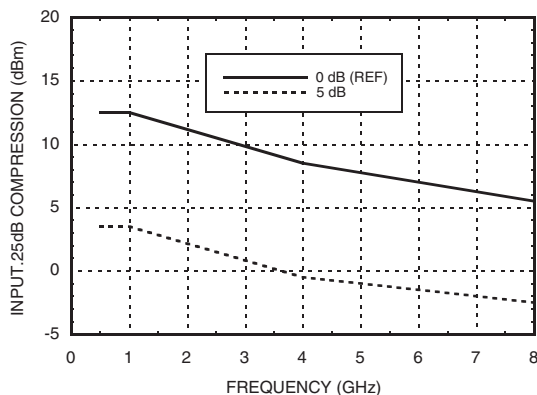

1 dB Compression vs. Attenuation

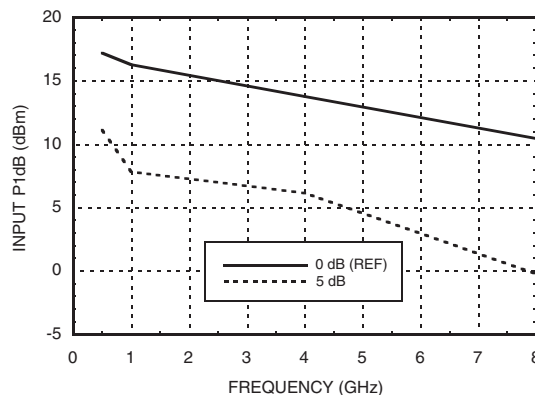

Second Harmonic vs. Attenuation

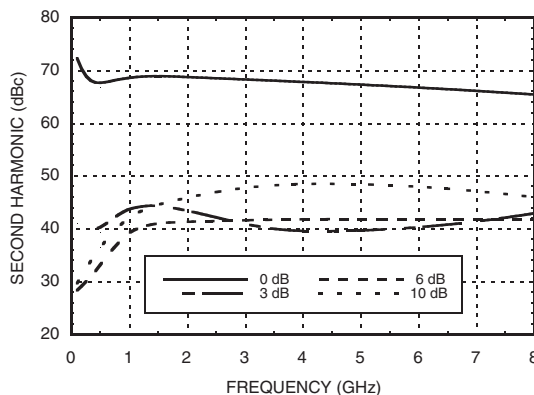

*Two-tone input power = -8 dBm each tone, 1 MHz spacing.



GaAs MMIC SMT VOLTAGE-VARIABLE ATTENUATOR, DC - 8 GHz

Absolute Maximum Ratings

RF Input Power	+18 dBm
Control Voltage Range	+1 to -5 V
Storage Temperature	-65 to +150 °C
Operating Temperature	-40 to +85 °C
ESD Sensitivity (HBM)	Class 1A



ELECTROSTATIC SENSITIVE DEVICE
OBSERVE HANDLING PRECAUTIONS

Outline Drawing

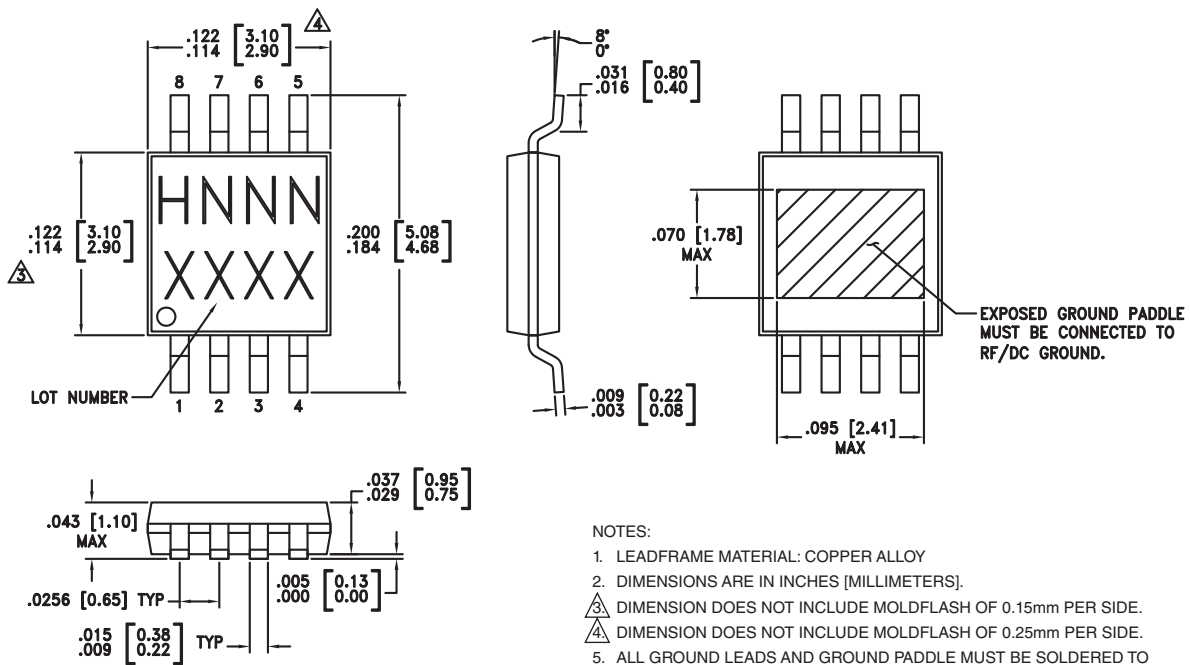

NOTES:

- LEADFRAME MATERIAL: COPPER ALLOY
- DIMENSIONS ARE IN INCHES [MILLIMETERS].
- [3] DIMENSION DOES NOT INCLUDE MOLDFLASH OF 0.15mm PER SIDE.
- [4] DIMENSION DOES NOT INCLUDE MOLDFLASH OF 0.25mm PER SIDE.
- ALL GROUND LEADS AND GROUND PADDLE MUST BE SOLDERED TO PCB RF GROUND.

Package Information

Part Number	Package Body Material	Lead Finish	MSL Rating	Package Marking ^[3]
HMC346MS8G	Low Stress Injection Molded Plastic	Sn/Pb Solder	MSL1 ^[1]	H346 XXXX
HMC346MS8GE	RoHS-compliant Low Stress Injection Molded Plastic	100% matte Sn	MSL1 ^[2]	H346 XXXX

[1] Max peak reflow temperature of 235 °C

[2] Max peak reflow temperature of 260 °C

[3] 4-Digit lot number XXXX



**GaAs MMIC SMT VOLTAGE-VARIABLE
ATTENUATOR, DC - 8 GHz**

Pin Descriptions

Pin Number	Function	Description	Interface Schematic
1, 8	RF1 RF2	This pin is DC coupled and matched to 50 Ohm. Blocking capacitors are required if RF line potential is not equal to 0V.	
2, 7	GND	This pin must be DC grounded.	
3, 6	V2, V1	Control Input (Master).	
4	I	Control Input (Slave).	
5	N/C	Not Connected.	

Single-Line Control Driver

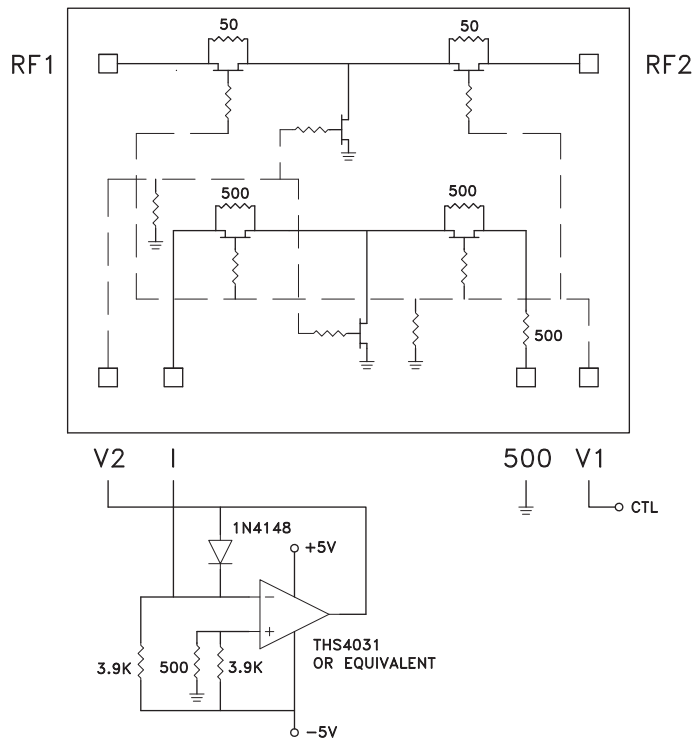

External op-amp control circuit maintains impedance match while attenuation is varied. Input control ranges from 0 Volts (min. attenuation) to -2.5 Volts (max. attenuation.)

Information furnished by Analog Devices is believed to be accurate and reliable. However, no responsibility is assumed by Analog Devices for its use, nor for any infringements of patents or other rights of third parties that may result from its use. Specifications subject to change without notice. No license is granted by implication or otherwise under any patent or patent rights of Analog Devices. Trademarks and registered trademarks are the property of their respective owners.

For price, delivery, and to place orders: Analog Devices, Inc., One Technology Way, P.O. Box 9106, Norwood, MA 02062-9106 Phone: 781-329-4700 • Order online at www.analog.com Application Support: Phone: 1-800-ANALOG-D

Evaluation PCB

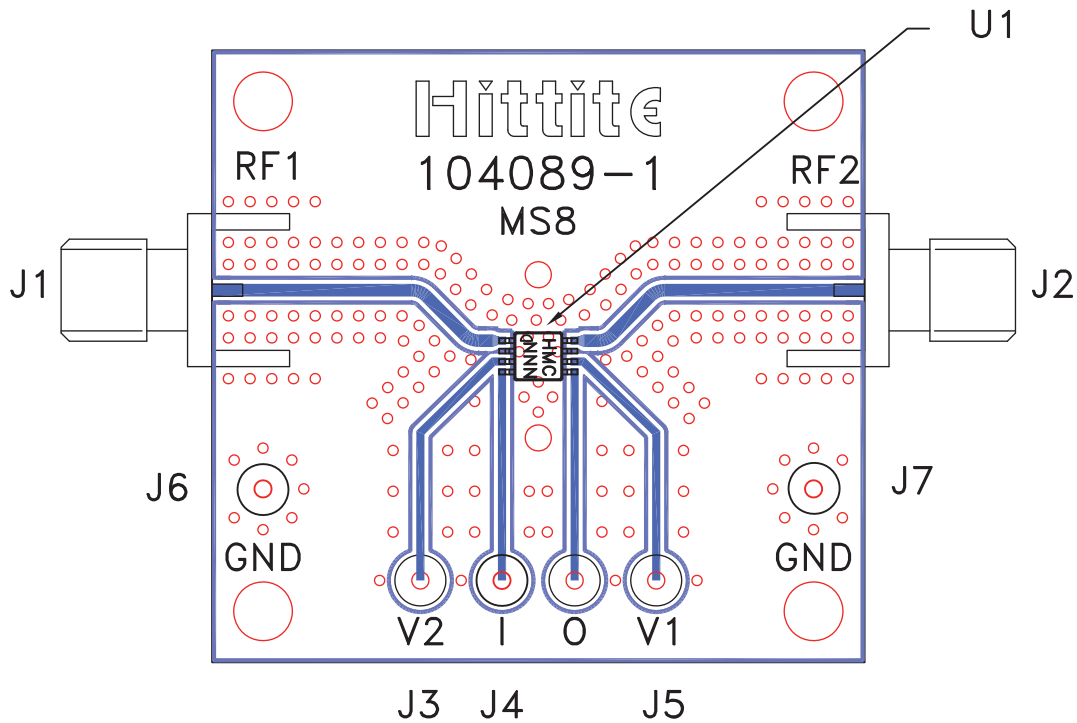

List of Materials for Evaluation PCB 104091 [1]

Item	Description
J1 - J2	PCB Mount SMA RF Connector
J3 - J7	DC PIN
U1	HMC346MS8G / HMC346MS8GE
PCB [2]	104089 Eval Board

[1] Reference this number when ordering complete evaluation PCB

[2] Circuit Board Material: Rogers 4350

The circuit board used in the final application should be generated with proper RF circuit design techniques. Signal lines at the RF ports should be 50 ohm impedance and the package ground leads and package bottom should be connected directly to the PCB RF ground plane, similar to that shown above. The evaluation circuit board shown above is available from Hittite Microwave Corporation upon request.