

DATA SHEET

# AS214-92LF: PHEMT GaAs IC SPDT Switch 0.1 to 3 GHz

## Applications

- T/R switch in WLANs, Bluetooth® and medium-power telecommunication applications

## Features

- Low insertion loss (0.4 dB @ 2.4 GHz)
- Isolation 26 dB @ 2.4 GHz
- Low DC power consumption
- PHEMT process
- Operates at 1.8 V control voltage
- Available lead (Pb)-free and RoHS-compliant (MSL-1 @ 260 °C per JEDEC J-STD-020)



Skyworks Green™ products are compliant with all applicable legislation and are halogen-free. For additional information, refer to *Skyworks Definition of Green™*, document number SQ04-0074.

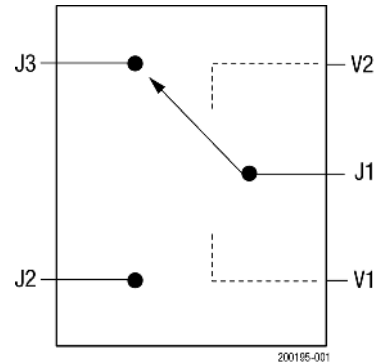

Figure 1. AS214-92LF Block Diagram

## Description

The AS214-92LF is a medium-power IC FET SPDT switch in a low-cost miniature SC-70 6-lead plastic package. The AS214-92LF features low insertion loss and positive voltage operation with very low DC power consumption. This general purpose switch can be used in a variety of telecommunications applications.

A functional block diagram is shown in Figure 1. The pin configuration and package are shown in Figure 2. Signal pin assignments and functional pin descriptions are provided in Table 1.

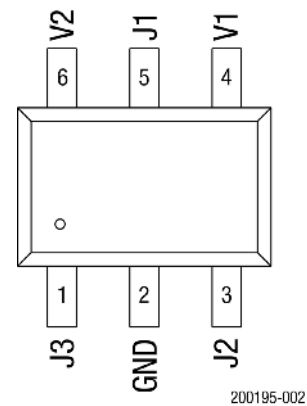

Figure 2. AS214-92LF Pinout (Top View)

**Table 1. AS214-92LF Signal Assignments and Functional Descriptions**

Pin	Name	Description	Pin	Name	Description
1	J3	RF output <sup>1</sup>	4	V1	DC control voltage
2	GND	Ground	5	J1	RF output <sup>1</sup>
3	J2	RF output <sup>1</sup>	6	V2	DC control voltage

<sup>1</sup> A 100 pF blocking capacitor is required for >500 MHz operation. Use larger value capacitors for lower frequency operation.

### Electrical and Mechanical Specifications

The absolute maximum ratings of the AS214-92LF are provided in Table 2. The electrical specifications of the AS214-92LF are provided in Table 3.

Typical performance characteristics are shown in Figures 3, 4, and 5. Table 4 shows the truth table.

**Table 2. AS214-92LF Absolute Maximum Ratings<sup>1</sup>**

Parameter	Symbol	Minimum	Maximum	Units
Control voltage	V <sub>CTL</sub>	-0.2	+8.0	V
Supply voltage			+8.0	V
RF input power (V <sub>CTL</sub> = 0 to 8 V):				
>500 MHz			2	W
<500 MHz			500	mW
Operating temperature	T <sub>OP</sub>	-40	+85	°C
Operating temperature (Pin <sub>max</sub> < +32 dBm for T <sub>OP</sub> = 105 °C)	T <sub>OP</sub>	-40	+105	°C
Storage temperature	T <sub>STG</sub>	-65	+150	°C

<sup>1</sup> Exposure to maximum rating conditions for extended periods may reduce device reliability. There is no damage to device with only one parameter set at the limit and all other parameters set at or below their nominal value.

---

**ESD HANDLING:** *Although this device is designed to be as robust as possible, electrostatic discharge (ESD) can damage this device. This device must be protected at all times from ESD when handling or transporting. Static charges may easily produce potentials of several kilovolts on the human body or equipment, which can discharge without detection. Industry-standard ESD handling precautions should be used at all times.*

---

**Table 3. AS214-92LF Electrical Specifications<sup>1</sup>**

( $V_{CTL} = 0$  to 3 V,  $T_{OP} = +25$  °C, Characteristic Impedance = 50  $\Omega$ , Unless Otherwise Noted)

Parameter	Symbol	Test Condition	Min	Typical	Max	Units
Insertion loss <sup>2</sup>	IL	0.5 to 1.0 GHz		0.3	0.5	dB
		1.0 to 2.0 GHz		0.4	0.6	dB
		2.0 to 3.0 GHz		0.4	0.6	dB
Isolation	ISO	0.5 to 1.0 GHz	27	30		dB
		1.0 to 2.0 GHz	24	27		dB
		2.0 to 3.0 GHz	22	25		dB
VSWR <sup>3</sup>	VSWR	0.5 to 1.0 GHz		1.1:1		
		1.0 to 2.0 GHz		1.1:1		
		2.0 to 3.0 GHz		1.4:1		
Switching characteristics: Rise/fall On/off Video feedthrough		10/90% or 90/10% RF 50% control to 90/10% RF $t_R = 1$ ns, bandwidth = 500 MHz		10 20 25		ns ns mV
1 dB input compression point: 0.5 to 3.0 GHz 0.5 to 3.0 GHz	IP1dB	$V_{CTL} = 0$ to 1.8 V $V_{CTL} = 0$ to 3 V		+20 +27		dBm dBm
Third order intercept point @ 0.5 to 3.0 GHz	IP3	+5 dBm two-tone input power, $V_{CTL} = 0$ to 3 V		+40		dBm
Thermal resistance				25		°C/W
Control voltages		$V_{LOW} = 0$ to 0.2 V @ 20 $\mu$ A max. $V_{HIGH} = 2.7$ V @ 100 $\mu$ A max. to 5 V @ 200 $\mu$ A max.				

<sup>1</sup> Performance is guaranteed only under the conditions listed in this table.

<sup>2</sup> Insertion loss changes by 0.003 dB/°C.

<sup>3</sup> Insertion loss state.

**Table 4. AS214-92LF Truth Table**

V <sub>1</sub>	V <sub>2</sub>	J <sub>1</sub> -J <sub>2</sub>	J <sub>1</sub> -J <sub>3</sub>
VHIGH	0	Isolation	Insertion loss
0	VHIGH	Insertion loss	Isolation

### Typical Performance Characteristics

( $V_{CTL} = 0$  to 3 V,  $T_{OP} = +25$  °C,  $P_{IN} = 0$  dBm, Characteristic Impedance [ $Z_0$ ] = 50  $\Omega$ ,  $C_{BL} = 100$  pF, Unless Otherwise Noted)

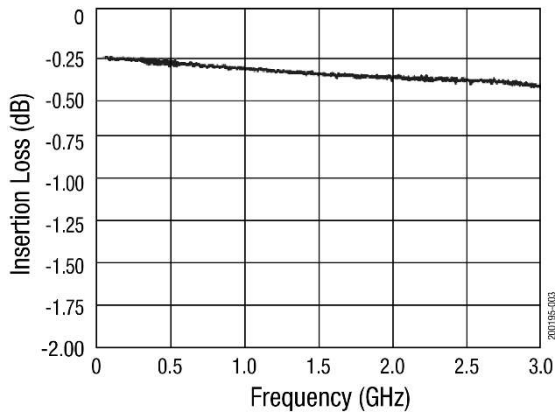

Figure 3. Insertion Loss vs Frequency

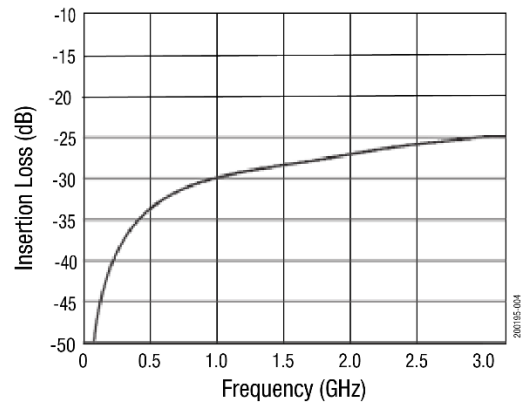

Figure 4. Isolation vs Frequency

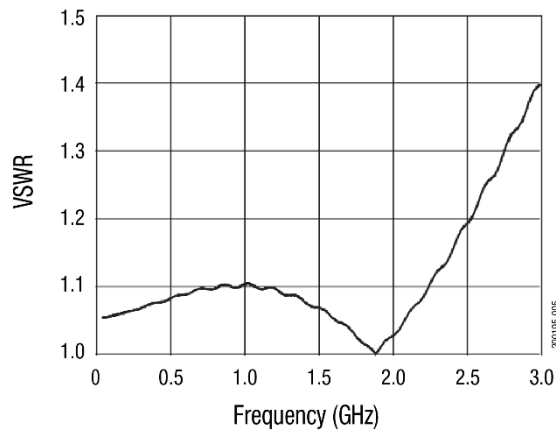
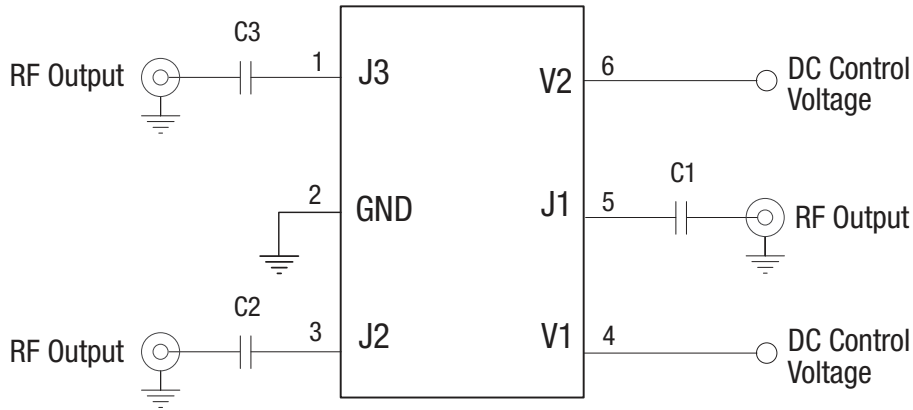

Figure 5. VSWR vs Frequency

### Evaluation Board Description

The AS214-92LF Evaluation Board is used to test the performance of the AS214-92LF SPDT switch. An Evaluation Board schematic

diagram is provided in Figure 6. An assembly drawing for the Evaluation Board is shown in Figure 7.



Note: Use 100 pF blocking capacitors (C1, C2, C3) for >500 MHz operation. Higher values recommended for lower frequency operation. Exposed paddle must be grounded.  
Use 10 nF blocking capacitors (C1, C2, C3) for <50 MHz operation.

S2108

**Figure 6. AS214-92LF Evaluation Board Schematic**

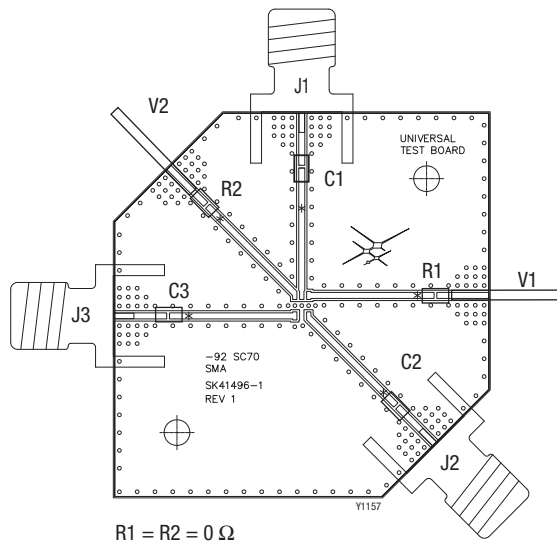

**Figure 7. AS214-92LF Evaluation Board Assembly Diagram**

### Package Dimensions

The PCB layout footprint is shown in Figure 8. Package dimensions are shown in Figure 9, and tape and reel dimensions are provided in Figure 10.

### Package and Handling Information

Instructions on the shipping container label regarding exposure to moisture after the container seal is broken must be followed. Otherwise, problems related to moisture absorption may occur when the part is subjected to high temperature during solder assembly.

The AS214-92LF is rated to Moisture Sensitivity Level 1 (MSL1) at 260 °C. It can be used for lead or lead-free soldering.

Care must be taken when attaching this product, whether it is done manually or in a production solder reflow environment. Production quantities of this product are shipped in a standard tape and reel format.

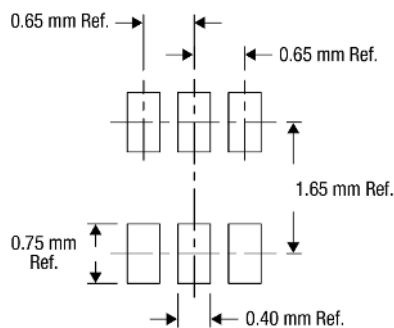

200195-008

**Figure 8. AS214-92LF PCB Layout Footprint**

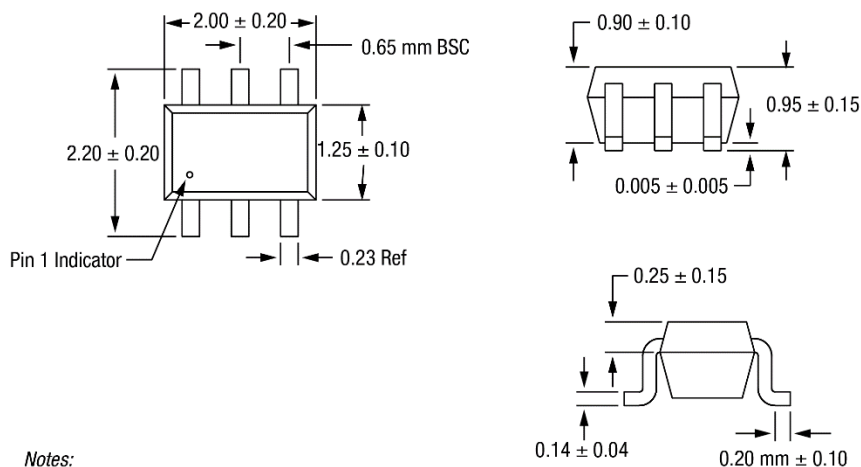

Notes:

1. All measurements are in millimeters.
2. Dimensions and tolerances according to ASME Y14.5M-1994.

200195-008

**Figure 9. AS214-92LF Package Dimensions**

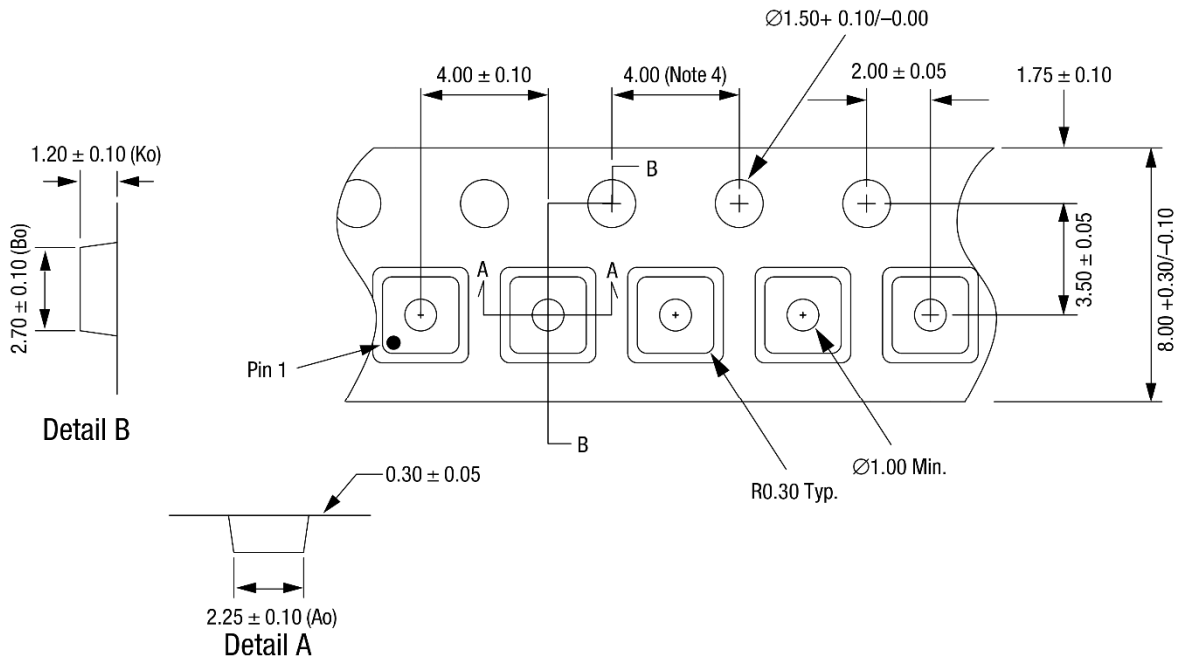

Notes:

1. Carrier tape: black conductive polystyrene.
2. Cover tape material: transparent conductive HSA.
3. Cover tape size: 5.40 mm width.
4. Ten sprocket hole pitch cumulative tolerance  $\pm 0.20$  mm.
5. All measurements are in millimeters.

200195-009

**Figure 10. AS214-92LF Tape and Reel Dimensions**

## Ordering Information

Part Number	Product Description	Evaluation Board Part Number
AS214-92LF	20 MHz to 3.0 GHz SPDT Switch	AS214-92LF-EVB

Copyright © 2002-2005, 2019 Skyworks Solutions, Inc. All Rights Reserved.

Information in this document is provided in connection with Skyworks Solutions, Inc. ("Skyworks") products or services. These materials, including the information contained herein, are provided by Skyworks as a service to its customers and may be used for informational purposes only by the customer. Skyworks assumes no responsibility for errors or omissions in these materials or the information contained herein. Skyworks may change its documentation, products, services, specifications or product descriptions at any time, without notice. Skyworks makes no commitment to update the materials or information and shall have no responsibility whatsoever for conflicts, incompatibilities, or other difficulties arising from any future changes.

No license, whether express, implied, by estoppel or otherwise, is granted to any intellectual property rights by this document. Skyworks assumes no liability for any materials, products or information provided hereunder, including the sale, distribution, reproduction or use of Skyworks products, information or materials, except as may be provided in Skyworks Terms and Conditions of Sale.

THE MATERIALS, PRODUCTS AND INFORMATION ARE PROVIDED "AS IS" WITHOUT WARRANTY OF ANY KIND, WHETHER EXPRESS, IMPLIED, STATUTORY, OR OTHERWISE, INCLUDING FITNESS FOR A PARTICULAR PURPOSE OR USE, MERCHANTABILITY, PERFORMANCE, QUALITY OR NON-INFRINGEMENT OF ANY INTELLECTUAL PROPERTY RIGHT; ALL SUCH WARRANTIES ARE HEREBY EXPRESSLY DISCLAIMED. SKYWORKS DOES NOT WARRANT THE ACCURACY OR COMPLETENESS OF THE INFORMATION, TEXT, GRAPHICS OR OTHER ITEMS CONTAINED WITHIN THESE MATERIALS. SKYWORKS SHALL NOT BE LIABLE FOR ANY DAMAGES, INCLUDING BUT NOT LIMITED TO ANY SPECIAL, INDIRECT, INCIDENTAL, STATUTORY, OR CONSEQUENTIAL DAMAGES, INCLUDING WITHOUT LIMITATION, LOST REVENUES OR LOST PROFITS THAT MAY RESULT FROM THE USE OF THE MATERIALS OR INFORMATION, WHETHER OR NOT THE RECIPIENT OF MATERIALS HAS BEEN ADVISED OF THE POSSIBILITY OF SUCH DAMAGE.

Skyworks products are not intended for use in medical, lifesaving or life-sustaining applications, or other equipment in which the failure of the Skyworks products could lead to personal injury, death, physical or environmental damage. Skyworks customers using or selling Skyworks products for use in such applications do so at their own risk and agree to fully indemnify Skyworks for any damages resulting from such improper use or sale.

Customers are responsible for their products and applications using Skyworks products, which may deviate from published specifications as a result of design defects, errors, or operation of products outside of published parameters or design specifications. Customers should include design and operating safeguards to minimize these and other risks. Skyworks assumes no liability for applications assistance, customer product design, or damage to any equipment resulting from the use of Skyworks products outside of stated published specifications or parameters.

Skyworks and the Skyworks symbol are trademarks or registered trademarks of Skyworks Solutions, Inc. or its subsidiaries in the United States and other countries. Third-party brands and names are for identification purposes only, and are the property of their respective owners. Additional information, including relevant terms and conditions, posted at [www.skyworksinc.com](http://www.skyworksinc.com), are incorporated by reference.