

# GM5BW9733xA (Series)

## Light Emitting Diode



### ■ Features

1. 3-chip devices, the given output at  $I_F = 20 \text{ mA/chip}$
2. White Color (achieved via InGaN/SiC Blue LED chips in combination with Yellow Phosphor)
3. Three Part Numbers, each with a different color temperature in this part number's family for design flexibility:

Part Number	Luminous Intensity	Lumens*	Color Temperature
GM5BW97330A	6.40 cd	(17)	5300 K
GM5BW97332A	5.80 cd	(15)	6700 K
GM5BW97333A	5.10 cd	(12)	11500 K

\*Calculated values; See page 3 for more information.

### ■ Agency Approvals/Compliance

1. RoHS compliant

### ■ Applications

1. General indication (indoor use only)
2. Office Automation equipment
3. Audio/visual equipment
4. Home appliances
5. Telecommunications equipment
6. Measuring equipment
7. Machine tools
8. Computers

Notice The content of data sheet is subject to change without prior notice.  
In the absence of confirmation by device specification sheets, SHARP takes no responsibility for any defects that may occur in equipment using any SHARP devices shown in catalogs, data books, etc. Contact SHARP in order to obtain the latest device specification sheets before using any SHARP device.

External Dimensions

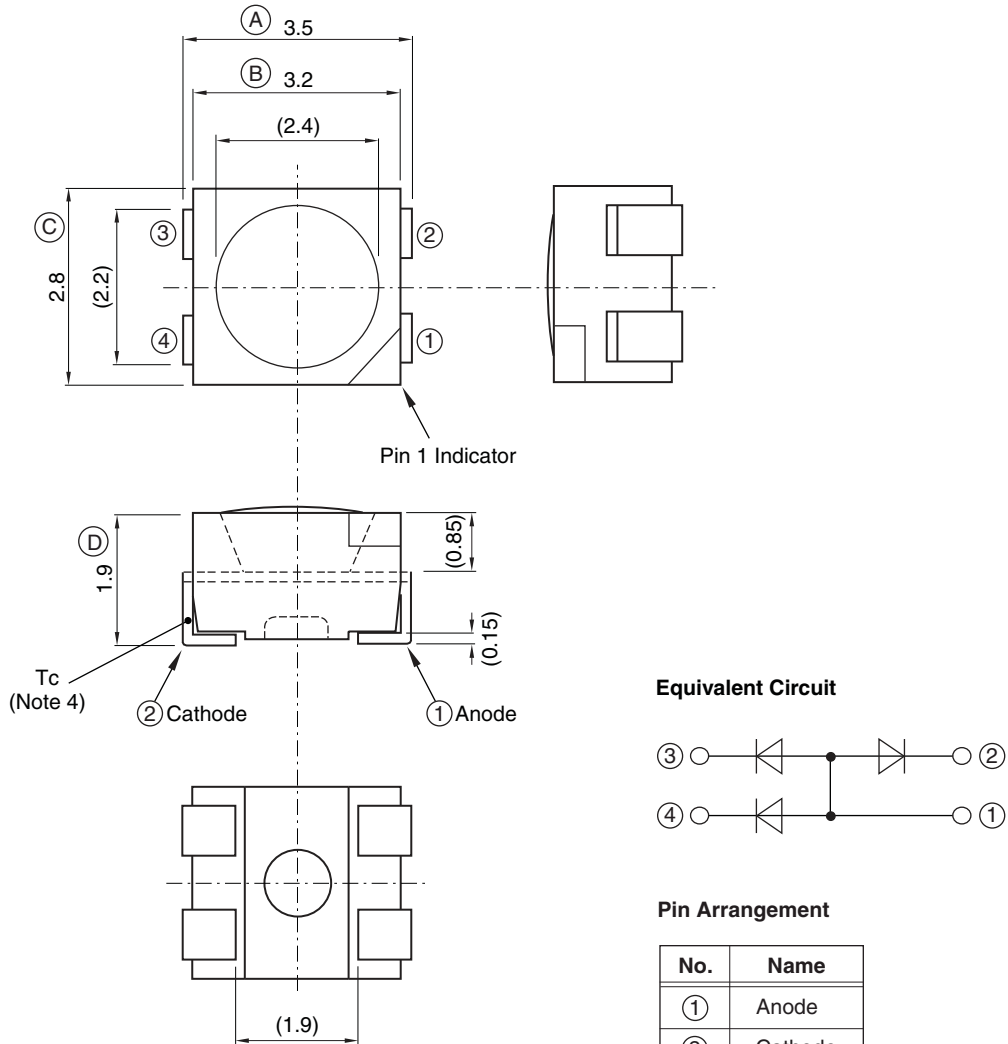

**NOTES:**

- 1. Units: mm
- 2. Unspecified tolerance:  $\pm 0.3$  mm
- 3. ( ): Reference dimensions
- 4. Case temperature (Tc) measurement point
- 5. Materials: Leads: Copper alloy, Ag plating  
Package: Nylon and silicone resin

**Equivalent Circuit**

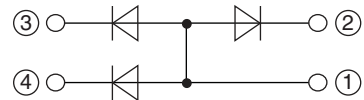

**Pin Arrangement**

No.	Name
①	Anode
②	Cathode
③	Cathode
④	Cathode

## ■ Absolute Maximum Ratings

(T<sub>c</sub> = 25°C)

Parameter	Symbol	Rating	Unit
Power dissipation (Package total)	P	300	mW
Forward current *1	I <sub>F</sub>	30	mA
Peak pulsed forward current *1, *2	I <sub>FM</sub>	100	mA
Forward current derating factor *1, 2	DC	0.50	mA/°C
	Pulse	1.67	mA/°C
Reverse voltage *1	V <sub>R</sub>	5	V
Junction Temperature *3	T <sub>j</sub>	120	°C
Operating temperature *4	T <sub>c</sub>	-30 to +100	°C
Storage temperature *5	T <sub>stg</sub>	-40 to +100	°C
Soldering temperature *6	T <sub>sol</sub>	295	°C

\*1 Rating for single chip (die) operation.

\*2 Duty ratio = 1/10, Pulse width = 0.1 ms

\*3 Thermal resistance, junction-to-case = 120°C/W

\*4 Case temperature (See External Dimensions on page 2)

\*5 Do not exceed these temperatures under any condition while in packing. Refer to *Storage and Handling*.

\*6 Each terminal must be soldered with a 30 W soldering iron within 3 seconds under 295°C.

For Reflow Soldering information, see Fig. 18.

\*7 Operating current values here follow the derating curves shown in Fig. 1 through Fig. 3.

\*8 This device uses the leads for heat sinking, therefore the operating temperature range is prescribed by T<sub>c</sub>.

## ■ Electro-optical Characteristics

(T<sub>c</sub> = 25°C)

Parameter	Symbol	Conditions	MIN.	TYP.	MAX.	Unit		
Forward voltage *1	V <sub>F</sub>	I <sub>F</sub> = 20 mA (per chip, all chips on)	2.9	(3.2)	3.5	V		
Luminous intensity GM5BW97330A *1, *2	I <sub>v</sub>				(6.40)		cd	
Luminous intensity GM5BW97332A *1, *2					(5.80)		cd	
Luminous intensity GM5BW97333A *1, *2						(5.10)		cd
Luminous flux GM5BW97330A *4						(17)		lm
Luminous flux GM5BW97332A *4						(15)		lm
Luminous flux GM5BW97333A *4						(12)		lm
Chromaticity coordinates GM5BW97330A *1, *3	x, y				(0.338, 0.356)			
Chromaticity coordinates GM5BW97332A *1, *3					(0.312, 0.311)			
Chromaticity coordinates GM5BW97333A *1, *3						(0.283, 0.262)		
Reverse current *1	I <sub>R</sub>	V <sub>R</sub> = 4 V (per chip)	—	—	10	μA		

\*1 Rating for three-chip (die) operation.

\*2 Measured by EG&amp;G Model 550 (Radiometer/Photometer) after 20 ms drive (Tolerance: ±15%) See the Luminosity Rank table for ranking range details.

\*3 Measured by Otuka Electronics Model MCPD-2000 after 20 ms drive (Tolerance: x, y: ±0.02). All chips (die) operating. See the Chromaticity Rank table for ranking range details.

\*4 Calculated values; for reference only.

\*5 Parens indicate reference values.

**Derating Curves**

Figures 1, 2, and 3 apply to single-chip operation only. Figure 4 applies to three chip operation; however each chip must follow the limitations for the Forward Current Derating Curve (Forward Current vs. Case Temperature).

**Fig. 1 Forward Current vs. Case Temperature**

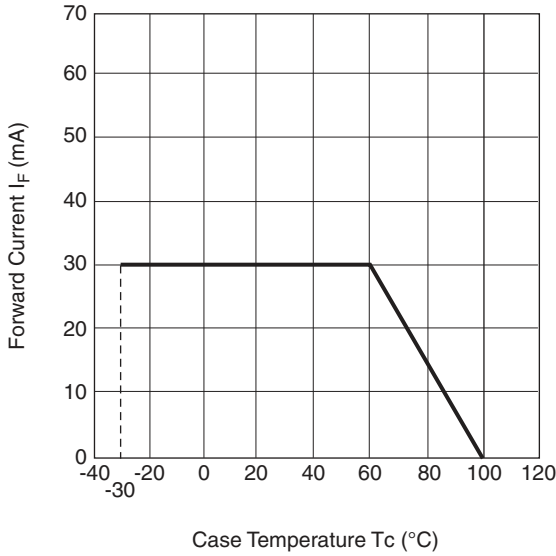

GM5BW9733xA-2

**Fig. 2 Peak Pulsed Forward Current vs. Duty Ratio**

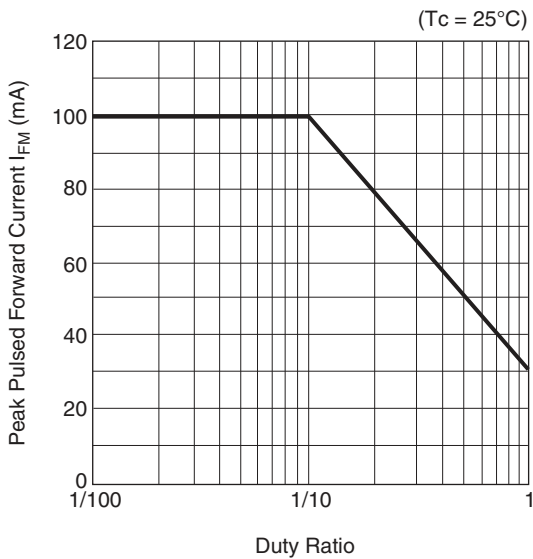

GM5BW9733xA-4

**Fig. 3 Peak Pulsed Forward Current vs. Case Temperature**

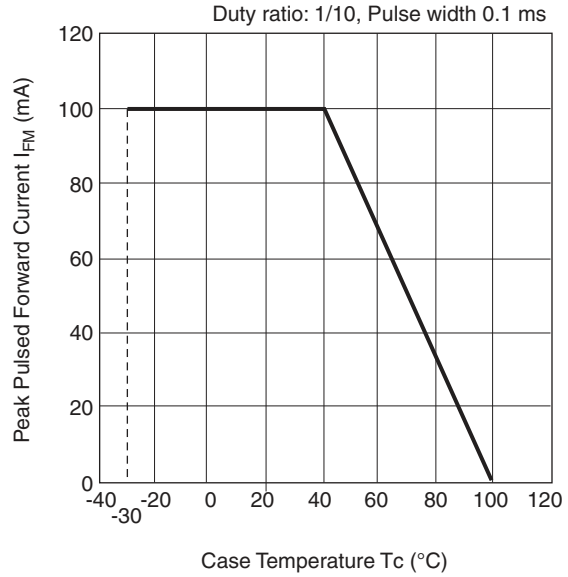

GM5BW9733xA-3

**Fig. 4 Power Dissipation vs. Case Temperature**

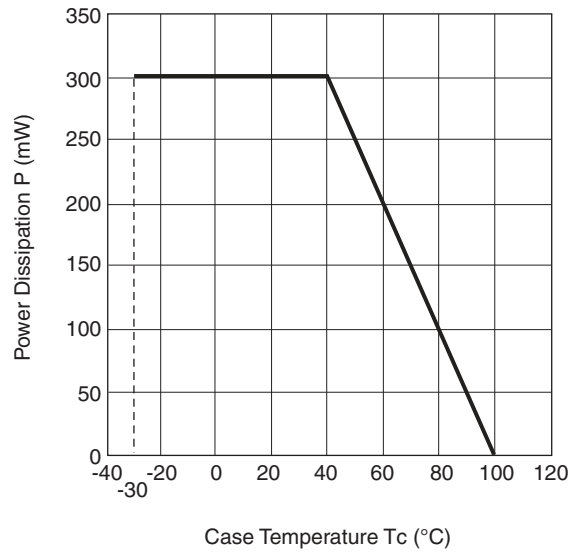

GM5BW9733xA-5

**■ Characteristic Diagrams (TYP.)**

Characteristics data are typical data and so are not guaranteed data.

**Fig. 5 Relative Luminous Intensity vs. Forward Current**

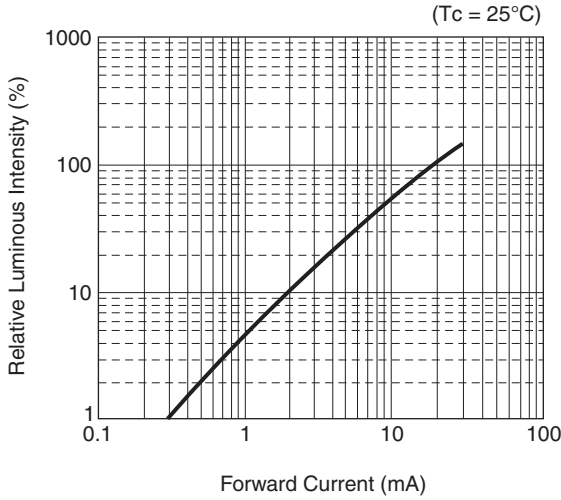

GM5BW9733xA-6

**Fig. 6 Forward Current vs. Forward Voltage**

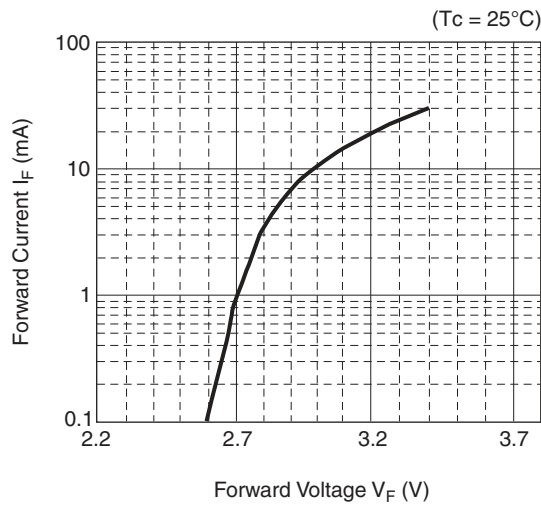

GM5BW9733xA-8

**Fig. 7 Relative Luminous Intensity vs. Case Temperature**

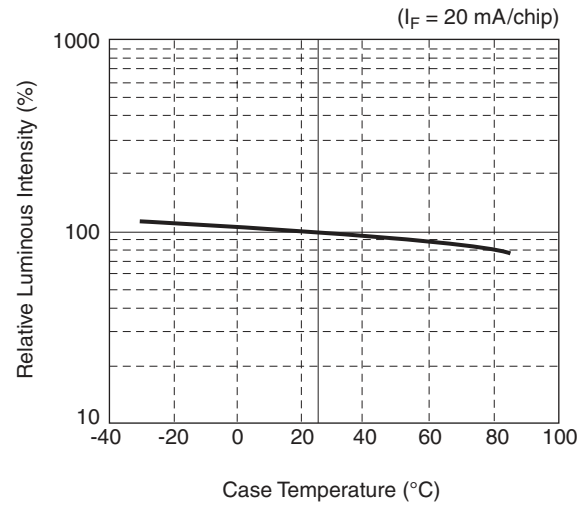

GM5BW9733xA-7

**Fig. 8 Forward Voltage vs. Case Temperature**

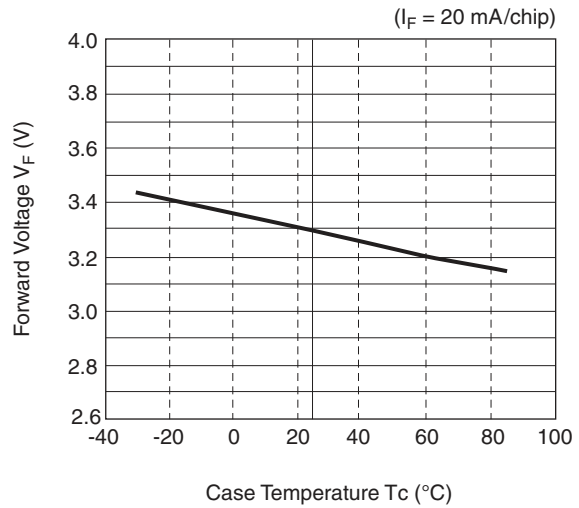

GM5BW9733xA-9

**Fig. 9 Relative Chromaticity vs. Forward Current**

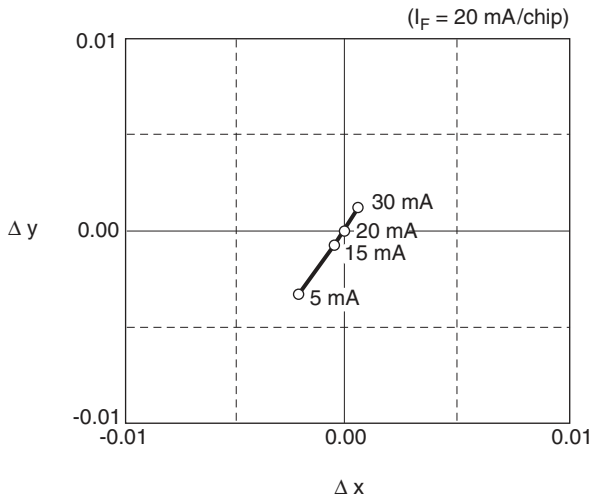

GM5BW9733xA-10

**Fig. 10 Chromaticity Coordinates vs. Case Temperature**

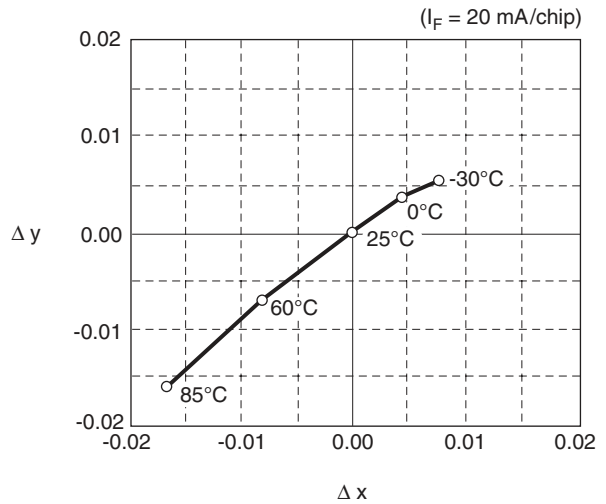

GM5BW9733xA-11

**■ Luminous Intensity Rank Table**

( $T_c = 25^\circ\text{C}$ )

Rank	Range	Unit	Conditions
A	4.5 to 5.0	cd	$I_F = 20 \text{ mA}$ (per chip, all 3 chips on)
B	5.0 to 5.5		
C	5.5 to 6.0		
D	6.0 to 6.5		
E	6.5 to 7.0		
F	7.0 to 7.5		

\*1 Mass-produced product will have ranking within these parameters.

**■ Chromaticity Rank Table**

( $T_c = 25^\circ\text{C}$ )

Rank	Chromaticity Coordinates (x, y)								Condition
	Point 1		Point 2		Point 3		Point 4		
	x	y	x	y	x	y	x	y	
a	0.2746	0.2677	0.2589	0.2420	0.2770	0.2278	0.2919	0.2550	$I_F = 20 \text{ mA}$ (per chip, all 3 chips on)
b	0.2900	0.2924	0.2746	0.2677	0.2919	0.2550	0.3061	0.2811	
c	0.3042	0.3160	0.2897	0.2924	0.3061	0.2811	0.3198	0.3061	
d	0.3181	0.3387	0.3042	0.3160	0.3198	0.3061	0.3329	0.3300	
e	0.3313	0.3603	0.3181	0.3387	0.3329	0.3300	0.3454	0.3528	
f	0.3439	0.3815	0.3313	0.3603	0.3454	0.3528	0.3573	0.3744	

\*1 Tolerance:  $\pm 0.02$ .

\*2 Mass-produced product will have ranking within these parameters.

\*3 Shipment quantities of each rank may not be specified by the Customer.

**Fig. 11 Chromaticity Diagram**

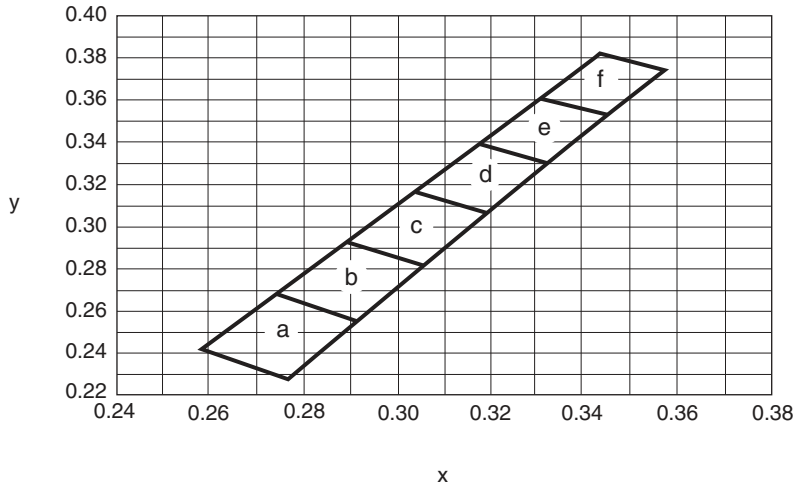

	<b>GM5BW97330A</b>	<b>GM5BW97332A</b>	<b>GM5BW97333A</b>
Luminous Intensity (Rank)	6.40 cd (C, D, E, F)	5.80 cd (B, C, D, E)	5.10 cd (A, B, C, D)
Chromaticity (Rank)	0.338, 0.356 (e, f)	0.312, 0.311 (c, d)	0.283, 0.262 (a, b)
Color Temperature	5300 K	6700 K	11500 K

GM5BW9733xA-12

■ Tape Specifications

Fig. 12 Tape Shape and Dimensions

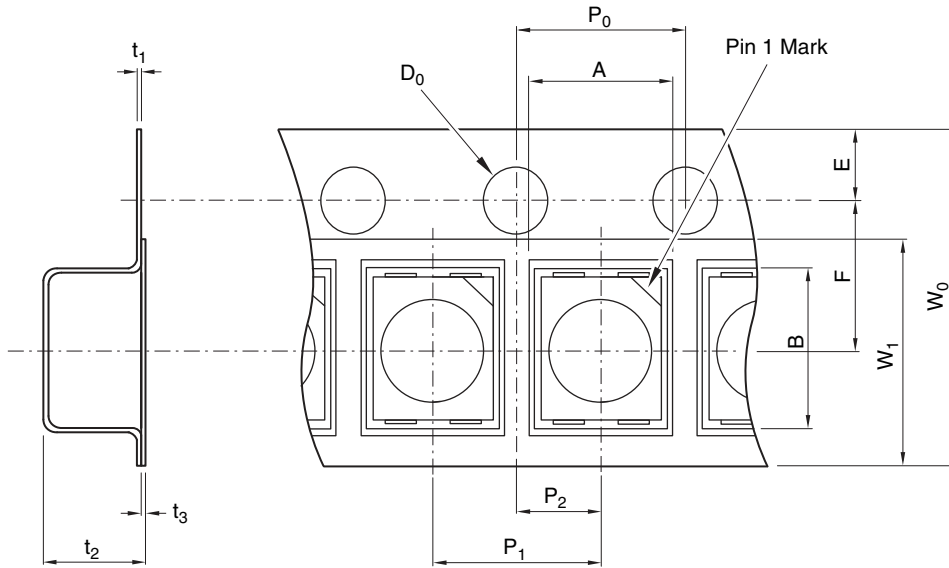

GM5BW9733xA-14

■ Tape Dimension Specifications

Parameter		Symbol	Dimension (mm)	Remarks
Embossed pocket	Vertical	A	3.0	Measured at inside bottom square corner
	Horizontal	B	3.7	
	Pitch	$P_1$	4.0	
Sprocket hole	Diameter	$D_0$	1.5	
	Pitch	$P_0$	4.0	Accumulated error $\pm 0.5$ mm/10 pitch
	Position	E	1.75	Distance between the edge of the tape and center of the hole
Pocket Position	Vertical	$P_2$	2.0	Distance between center lines of the concave square hole and round sprocket hole
	Horizontal	F	3.5	
Cover tape	Width	$W_1$	5.4	
	Thickness	$t_3$	0.1	
Carrier tape	Width	$W_0$	8.0	
	Thickness	$t_1$	0.3	
Overall thickness		$t_2$	2.6	Includes thickness of cover tape and carrier tape



■ Reel Specifications

Fig. 13 Reel Shape and Dimensions

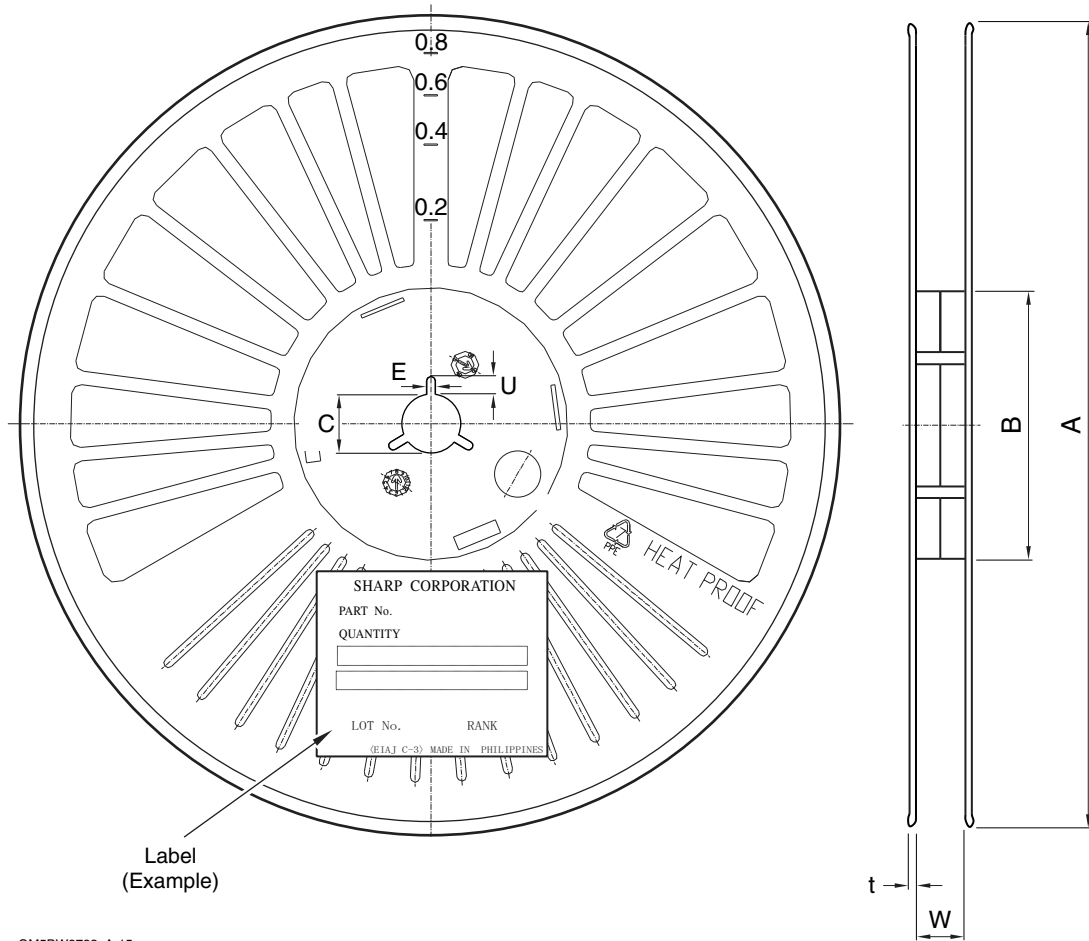

GM5BW9733xA-15

■ Reel Dimension Specifications

	Parameter	Symbol	Dimension (mm)	Remarks
Flange	Diameter	A	180	
	Thickness	t	1.3	
	Flange spacing	W	9.5	Shaft core dimension
Hub	External diameter	B	60	
	Spindle hole diameter	C	13	
	Key slit width	E	2.0	
	Key slit depth	U	4	

\*1 Label on side of flange: part number, quantity, lot number, and rank.

\*2 Material: described on flange.

**■ Taping Specifications**

1. Leader tape standard: JIS C0806

**Fig. 14 Leader Tape**

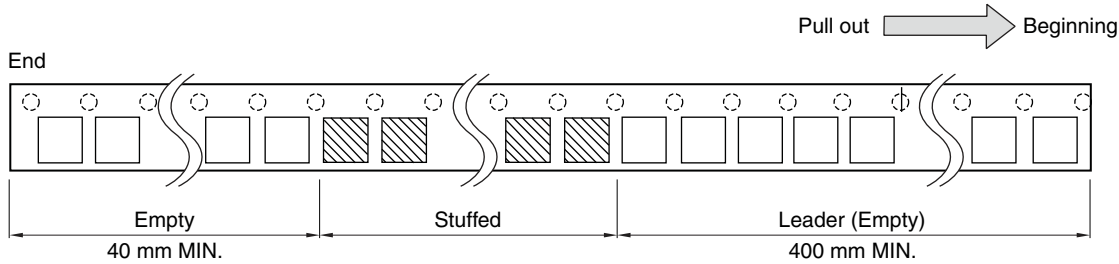

GM5BW9733xA-16

2. Cover tape peel resistance:  $F = 0.1$  to  $1.0$  N ( $\theta = 10^\circ$  or less). See Fig. 10.

**Fig. 15 Tape Separation**

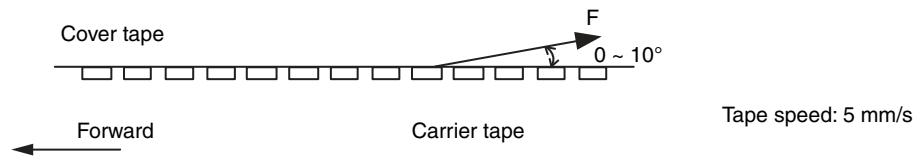

GM5BW9733xA-17

3. Tape bending resistance: Cover tape will remain in place on radii of 30 mm or more. Under 30 mm radii, the cover may separate.
4. Joints are not allowed in the cover tape.
5. Parts are packed with an average quantity of 2000 pieces per reel.
6. Product mass: 30 mg (approximately)
7. Sharp guarantees the following:
  - a. No contiguous empty spaces in the tape
  - b. Missing parts will not make up more than 0.1% of the total quantity.
  - c. Parts will be easily removed from the tape.
8. Parts will not stick to the cover tape as it is peeled.

■ Label and Marking Information

Fig. 16 Label Contents

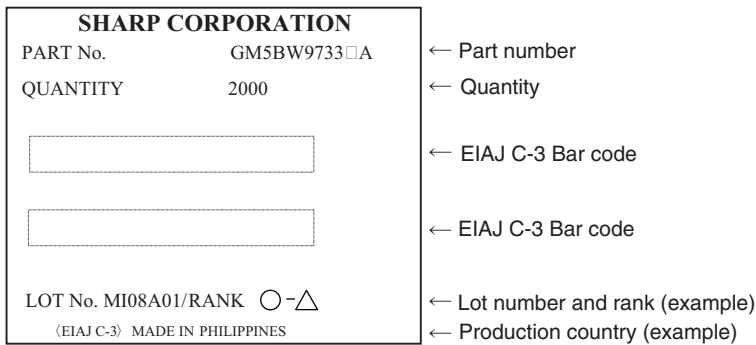

LOT Number

MI 08 A 01

① ② ③ ④

- ① Production plant code (alphabetically)
- ② Production year (the last two digits of the year)
- ③ Production month (alphabetically with January corresponding to A)
- ④ Production date (01 ~ 31)

Rank ○ : Luminous intensity rank  
 △ : Chromaticity rank

GM5BW9733xA-18

■ Design Notes

1. Do not allow the circuit to apply any reverse voltage to the LEDs at any time, operating or not. Do not bias this part in any manner when it is not operating. Reverse voltage can also be induced via EMF, generated by ambient light falling on this part. When these parts are operated in series, connect a zener diode parallel to each part to protect them from reverse voltage.
2. This part can be damaged by mechanical stress. Be certain that assembly steps do not stress this part; pay particular attention to pick-and-place equipment. Verify placing pressure and do not allow the collet to contact the resin of this part.
3. This product uses blue LED chips in combination with yellow phosphor to achieve its color. There may be some slight color change due to afterglow of the phosphor when driving this part with pulsed power.
4. This part has a high light output. Looking directly at it during full power output may cause injury.
5. Sharp recommends taking proper personal and environmental static control precautions when handling this part.
6. This device incorporates thermally conductive materials to allow heat to be transferred from it to the circuit board. For best reliability, do not locate other sources of heat near the LED, and design the circuit board for effective heat dissipation. Keep the part's case temperature under 100°C (LED ON) including self-heating.
7. Handle these parts in a clean environment; dust may be difficult to remove and can affect optical performance.
8. Confirm the part's performance, reliability, and resistance to degradation, if exposing it to these environments:
  - Direct sunlight, outdoor exposure, dusty conditions
  - In water, oil, medical fluids, and organic solvents
  - Excessive moisture, such as dew or condensation
  - Corrosive (salt) air or corrosive gases, such as Cl, H<sub>2</sub>S, NH<sub>3</sub>, SO<sub>2</sub>, NO<sub>x</sub>

## ■ Manufacturing Guidelines

### ● Storage and Handling

1. Moisture-proofing: These parts are shipped in vacuum-sealed bags to keep them dry and ready for use. See Fig. 17.

**Fig. 17 Factory Moisture-proof Packing**

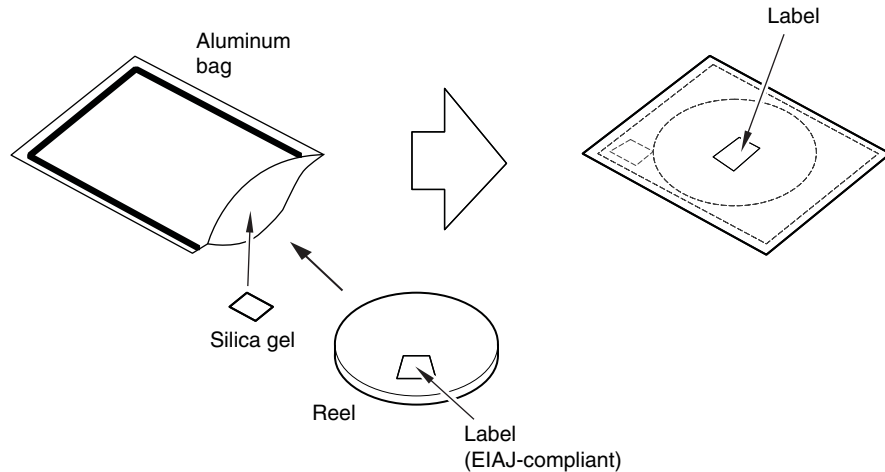

GM5BW9733xA-19

2. Store these parts between 5°C and 30°C, at a relative humidity of less than 70%; for no more than one year from the production date.
3. After breaking the package seal, maintain the environment within 5°C to 30°C, at a relative humidity of less than 60%. Solder the parts within 3 days.
4. If the parts will not be used immediately, repack them in a dry box, or re-vacuum-seal them with a desiccant.
5. If the parts are exposed to air for more than 3 days, or if the silica gel telltale indicates moisture contamination, bake the parts:
  - When in the tape carrier, bake them at a temperature of 95°C to 100°C, for 16 to 24 hours.
  - When loose or on a PCB, bake them at a temperature of 110°C to 120°C, for 8 to 12 hours.
  - Note that the reels may become distorted if they are in a stack when baking. Confirm that the parts have cooled to room temperature after baking.

### ● Cleaning Instructions

1. Sharp does not recommend cleaning printed circuit boards containing this device, or cleaning this device with ultrasonic methods. Process chemicals will affect the structural and optical characteristics of this device.
2. Sharp recommends the use of a solder paste that does not require cleaning.

## ● Soldering Instructions

1. When soldering with reflow methods, Sharp recommends following the soldering profile in Fig. 18.
2. Do not subject the package to excessive mechanical force during soldering as it may cause deformation or defects in plated connections. Internal connections may be severed due to mechanical force placed on the package due to the PCB flexing during the soldering process.
3. When using a second reflow, the second process should be carried out as soon as possible after the first.
4. Electrodes on this part are silver-plated. If the part is exposed to a corrosive environment, the plating may be damaged, thereby affecting solderability.
5. The Reflow Profile shown in Fig. 18 should be considered as a set of maximum parameters. Since this part uses the leads for heatsinking, the peak temperature should be kept as cool as possible and the cooldown period lengthened as much as possible. Thermal conduction into the LED will be affected by the performance of the reflow process, so verification of the reflow process is recommended. These parts may be used in a nitrogen reflow process.

**Fig. 18 Temperature Profile**

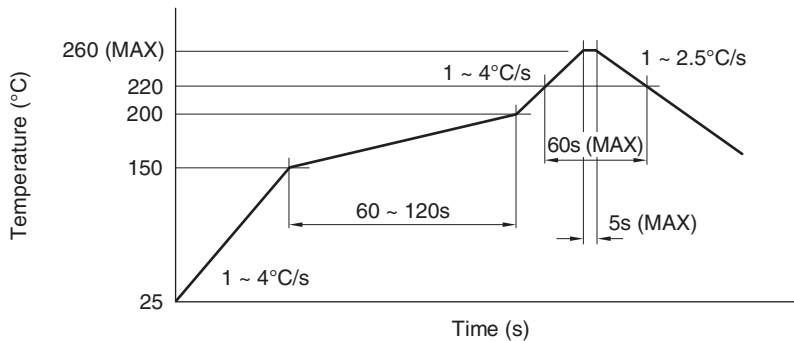

GM5BW9733xA-20

## ● Recommended Solder Pad Design

1. Solderability depends on reflow conditions, solder paste, and circuit board materials. Check the entire process before production commences.
2. Fig. 19 shows the recommended solder pad design for this part.
3. When using backside dip methods, Sharp recommends checking the process carefully: board warping from heat can cause mechanical failure in these parts, in addition to the high heat conducted into the part through the leads. Performing reflow after dip is recommended, with the interval between the two as short as possible.

**Fig. 19 Recommended Solder Pad Design**

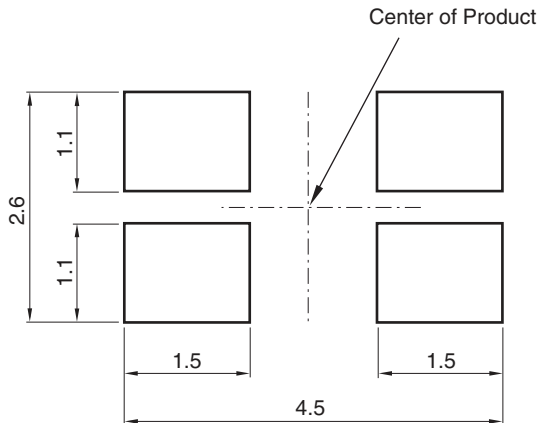

**NOTE:** Unit: mm

GM5BW9733xA-21

## ● Pick and Place Recommendations

1. Picking errors can occur based on the machine's setup, so Sharp recommends verification with the machine in actual use.
2. Do not allow the pick and place machine to contact the sealing resin in this part. If mechanical stress is placed on the sealing resin, such forces can cause the resin to fail, or cause bonding wires within the part to break.

## ■ Presence of ODCs

This product shall not contain the following materials, and they are not used in the production process for this product:

- Regulated substances: CFCs, Halon, Carbon tetrachloride, and 1,1,1-Trichloroethane (Methylchloroform). Specific brominated flame retardants such as the PBBOs and PBBs are not used in this product at all.

This product shall not contain the following materials banned in the RoHS Directive (2002/95/EC).

- Lead, Mercury, Cadmium, Hexavalent chromium, Polybrominated biphenyls (PBB), Polybrominated diphenyl ethers (PBDE).

## ■ Important Notices

· The circuit application examples in this publication are provided to explain representative applications of SHARP devices and are not intended to guarantee any circuit design or license any intellectual property rights. SHARP takes no responsibility for any problems related to any intellectual property right of a third party resulting from the use of SHARP's devices.

· Contact SHARP in order to obtain the latest device specification sheets before using any SHARP device. SHARP reserves the right to make changes in the specifications, characteristics, data materials, structure, and other contents described herein at any time without notice in order to improve design or reliability. Manufacturing locations are also subject to change without notice.

· Observe the following points when using any devices in this publication. SHARP takes no responsibility for damage caused by improper use of the devices which does not meet the conditions and absolute maximum ratings to be used specified in the relevant specification sheet nor meet the following conditions:

(i) The devices in this publication are designed for use in general electronic equipment designs such as:

- Personal computers
- Office automation equipment
- Telecommunication equipment (terminal)
- Test and measurement equipment
- Industrial control
- Audio visual equipment
- Consumer electronics

(ii) Measures such as fail-safe function and redundant design should be taken to ensure reliability and safety when SHARP devices are used for or in connection with equipment that requires higher reliability such as:

- Transportation control and safety equipment (i.e., aircraft, trains, automobiles, etc.)
- Traffic signals
- Gas leakage sensor breakers
- Alarm equipment
- Various safety devices, etc.

(iii) SHARP devices shall not be used for or in connection with equipment that requires an extremely high level of reliability and safety such as:

- Space applications
- Telecommunication equipment (trunk lines)
- Nuclear power control equipment
- Medical and other life support equipment (e.g. scuba)

· If the SHARP devices listed in this publication fall within the scope of strategic products described in the Foreign Exchange and Foreign Trade Law of Japan, it is necessary to obtain approval to export such SHARP devices.

· This publication is the proprietary product of SHARP and is copyrighted, with all rights reserved. Under the copyright laws, no part of this publication may be reproduced or transmitted in any form or by any means, electronic or mechanical, for any purpose, in whole or in part, without the express written permission of SHARP. Express written permission is also required before any use of this publication may be made by a third party.

· Contact and consult with a SHARP representative if there are any questions about the contents of this publication.