

# CSD87350Q5D Synchronous Buck NexFET™ Power Block

## 1 Features

- Half-Bridge Power Block
- 90% system Efficiency at 25 A
- Up to 40-A Operation
- High-Frequency Operation (Up to 1.5 MHz)
- High-Density SON 5-mm × 6-mm Footprint
- Optimized for 5-V Gate Drive
- Low-Switching Losses
- Ultra-Low-Inductance Package
- RoHS Compliant
- Halogen Free
- Lead-Free Terminal Plating

## 2 Applications

- Synchronous Buck Converters
  - High-Frequency Applications
  - High-Current, Low-Duty Cycle Applications
- Multiphase Synchronous Buck Converters
- POL DC-DC Converters
- IMVP, VRM, and VRD Applications

## 3 Description

The CSD87350Q5D NexFET™ power block is an optimized design for synchronous buck applications offering high-current, high-efficiency, and high-frequency capability in a small 5-mm × 6-mm outline. Optimized for 5-V gate drive applications, this product offers a flexible solution capable of offering a high-density power supply when paired with any 5-V gate drive from an external controller or driver.

Top View

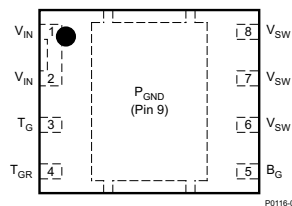

Device Information(1)

DEVICE	MEDIA	QTY	PACKAGE	SHIP
CSD87350Q5D	13-Inch Reel	2500	SON 5-mm × 6-mm Plastic Package	Tape and Reel

(1) For all available packages, see the orderable addendum at the end of the data sheet.

Typical Circuit

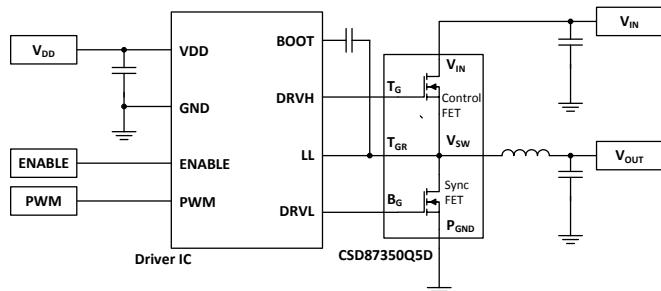

Typical Power Block Efficiency and Power Loss

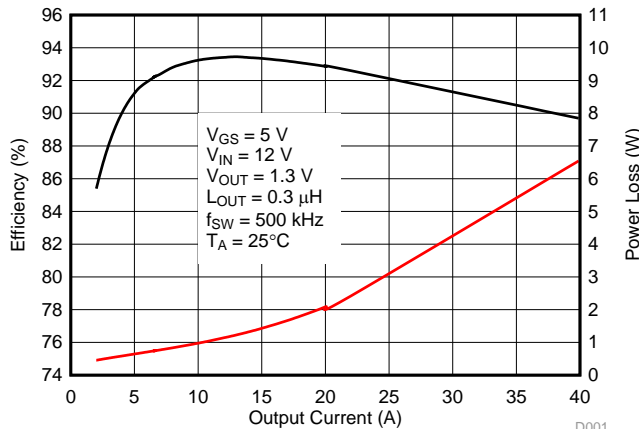

## Table of Contents

<b>1 Features</b> .....	<b>1</b>	<b>7 Layout</b> .....	<b>15</b>
<b>2 Applications</b> .....	<b>1</b>	7.1 Layout Guidelines .....	15
<b>3 Description</b> .....	<b>1</b>	7.2 Layout Example .....	16
<b>4 Revision History</b> .....	<b>2</b>	<b>8 Device and Documentation Support</b> .....	<b>17</b>
<b>5 Specifications</b> .....	<b>3</b>	8.1 Documentation Support .....	17
5.1 Absolute Maximum Ratings .....	3	8.2 Receiving Notification of Documentation Updates..	17
5.2 Recommended Operating Conditions .....	3	8.3 Community Resources .....	17
5.3 Thermal Information .....	3	8.4 Trademarks .....	17
5.4 Power Block Performance .....	3	8.5 Electrostatic Discharge Caution .....	17
5.5 Electrical Characteristics .....	4	8.6 Glossary .....	17
5.6 Typical Power Block Device Characteristics .....	5	<b>9 Mechanical, Packaging, and Orderable Information</b> .....	<b>18</b>
5.7 Typical Power Block MOSFET Characteristics .....	7	9.1 Q5D Package Dimensions .....	18
<b>6 Application and Implementation</b> .....	<b>10</b>	9.2 Land Pattern Recommendation .....	19
6.1 Application Information .....	10	9.3 Stencil Recommendation .....	19
6.2 Typical Application .....	13	9.4 Q5D Tape and Reel Information .....	20

## 4 Revision History

<b>Changes from Revision D (September 2014) to Revision E</b>	<b>Page</b>
• Added note for $I_{DM}$ in the <i>Absolute Maximum Ratings</i> table .....	3
• Added <i>Receiving Notification of Documentation Updates</i> section and <i>Community Resources</i> section in the <i>Documentation Support</i> section .....	17
<b>Changes from Revision C (October 2011) to Revision D</b>	<b>Page</b>
• Added <i>Handling Rating</i> table, <i>Application and Implementation</i> section, <i>Layout</i> section, <i>Device and Documentation Support</i> section, and <i>Mechanical, Packaging, and Orderable Information</i> section .....	1
<b>Changes from Revision B (September 2011) to Revision C</b>	<b>Page</b>
• Changed "DIM a" Millimeter Max value From: 1.55 To: 1.5 and Inches Max value From: 0.061 To: 0.059 .....	18
<b>Changes from Revision A (August 2011) to Revision B</b>	<b>Page</b>
• Replaced $R_{DS(on)}$ with $Z_{DS(on)}$ .....	4
• Added Equivalent System Performance section .....	10
• Added the Comparison of $R_{DS(on)}$ vs $Z_{DS(on)}$ table .....	12
• Added Electrical Performance bullet .....	15
<b>Changes from Original (March 2011) to Revision A</b>	<b>Page</b>
• Changed Power Dissipation, $P_D$ in the <i>Absolute Maximum Ratings</i> table From; 13 W to 12 W .....	3

## 5 Specifications

### 5.1 Absolute Maximum Ratings

 $T_A = 25^\circ\text{C}$  (unless otherwise noted)<sup>(1)</sup>

		MIN	MAX	UNIT
Voltage	$V_{IN}$ to $P_{GND}$	-0.8	30	V
	$T_G$ to $T_{GR}$	-8	10	V
	$B_G$ to $P_{GND}$	-8	10	V
$I_{DM}$	Pulsed current rating <sup>(2)</sup>		120	A
$P_D$	Power dissipation		12	W
$E_{AS}$	Avalanche energy	Sync FET, $I_D = 105\text{ A}$ , $L = 0.1\text{ mH}$	551	mJ
		Control FET, $I_D = 60\text{ A}$ , $L = 0.1\text{ mH}$	180	
$T_J$	Operating junction temperature	-55	150	$^\circ\text{C}$
$T_{stg}$	Storage temperature	-55	150	$^\circ\text{C}$

- (1) Stresses beyond those listed under *Absolute Maximum Ratings* may cause permanent damage to the device. These are stress ratings only, and functional operation of the device at these or any other conditions beyond those indicated in the *Recommended Operating Conditions* is not implied. Exposure to absolute-maximum-rated conditions for extended periods may affect device reliability.
- (2) Pulse duration  $\leq 50\ \mu\text{s}$ . Duty cycle  $\leq 0.01\%$ .

### 5.2 Recommended Operating Conditions

 $T_A = 25^\circ$  (unless otherwise noted)

		MIN	MAX	UNIT
$V_{GS}$	Gate drive voltage	4.5	8	V
$V_{IN}$	Input supply voltage		27	V
$f_{SW}$	Switching frequency $C_{BST} = 0.1\ \mu\text{F}$ (min)	200	1500	kHz
	Operating current		40	A
$T_J$	Operating temperature		125	$^\circ\text{C}$

### 5.3 Thermal Information

 $T_A = 25^\circ\text{C}$  (unless otherwise stated)

THERMAL METRIC		MIN	TYP	MAX	UNIT
$R_{\theta JA}$	Junction-to-ambient thermal resistance (min Cu) <sup>(1)(2)</sup>			102	$^\circ\text{C}/\text{W}$
	Junction-to-ambient thermal resistance (max Cu) <sup>(1)(2)</sup>			50	$^\circ\text{C}/\text{W}$
$R_{\theta JC}$	Junction-to-case thermal resistance (top of package) <sup>(2)</sup>			20	$^\circ\text{C}/\text{W}$
	Junction-to-case thermal resistance ( $P_{GND}$ pin) <sup>(2)</sup>			2	$^\circ\text{C}/\text{W}$

- (1) Device mounted on FR4 material with 1-in<sup>2</sup> (6.45-cm<sup>2</sup>) Cu.
- (2)  $R_{\theta JC}$  is determined with the device mounted on a 1-in<sup>2</sup> (6.45-cm<sup>2</sup>), 2-oz (0.071-mm) thick Cu pad on a 1.5-in  $\times$  1.5-in (3.81-cm  $\times$  3.81-cm), 0.06-in (1.52-mm) thick FR4 board.  $R_{\theta JC}$  is specified by design while  $R_{\theta JA}$  is determined by the user's board design.

### 5.4 Power Block Performance

 $T_A = 25^\circ$  (unless otherwise noted)

PARAMETER	TEST CONDITIONS	MIN	TYP	MAX	UNIT
$P_{LOSS}$	Power loss <sup>(1)</sup>		3		W
$I_{QVIN}$	$V_{IN}$ quiescent current		10		$\mu\text{A}$

- (1) Measurement made with six 10- $\mu\text{F}$  (TDK C3216X5R1C106KT or equivalent) ceramic capacitors placed across  $V_{IN}$  to  $P_{GND}$  pins and using a high-current 5-V driver IC.

## 5.5 Electrical Characteristics

 $T_A = 25^\circ\text{C}$  (unless otherwise stated)

PARAMETER		TEST CONDITIONS	Q1 CONTROL FET			Q2 SYNC FET			UNIT
			MIN	TYP	MAX	MIN	TYP	MAX	
<b>STATIC CHARACTERISTICS</b>									
$BV_{DSS}$	Drain-to-source voltage	$V_{GS} = 0\text{ V}, I_{DS} = 250\ \mu\text{A}$	30			30			V
$I_{DSS}$	Drain-to-source leakage current	$V_{GS} = 0\text{ V}, V_{DS} = 20\text{ V}$				1			$\mu\text{A}$
$I_{GSS}$	Gate-to-source leakage current	$V_{DS} = 0\text{ V}, V_{GS} = +10 / -8$				100			nA
$V_{GS(th)}$	Gate-to-source threshold voltage	$V_{DS} = V_{GS}, I_{DS} = 250\ \mu\text{A}$	1			2.1			V
$Z_{DS(on)}^{(1)}$	Effective AC on-impedance	$V_{IN} = 12\text{ V}, V_{GS} = 5\text{ V},$ $V_{OUT} = 1.3\text{ V}, I_{OUT} = 20\text{ A},$ $f_{SW} = 500\text{ kHz},$ $L_{OUT} = 0.3\ \mu\text{H}$	5			1.2			$\text{m}\Omega$
$g_{fs}$	Transconductance	$V_{DS} = 15\text{ V}, I_{DS} = 20\text{ A}$	97			157			S
<b>DYNAMIC CHARACTERISTICS</b>									
$C_{ISS}$	Input capacitance	$V_{GS} = 0\text{ V}, V_{DS} = 15\text{ V},$ $f = 1\text{ MHz}$	1360 1770			2950 3835			pF
$C_{OSS}$	Output capacitance		565 735			1300 1690			pF
$C_{RSS}$	Reverse transfer capacitance		19 25			50 65			pF
$R_G$	Series gate resistance		1.3 3			0.8 2			$\Omega$
$Q_g$	Gate charge total (4.5 V)		8.4 10.9			20 26			nC
$Q_{gd}$	Gate charge gate-to-drain	$V_{DS} = 15\text{ V},$ $I_{DS} = 20\text{ A}$	1.6			3.6			nC
$Q_{gs}$	Gate charge gate-to-source		2.6			4.3			nC
$Q_{g(th)}$	Gate charge at $V_{th}$		1.6			2.3			nC
$Q_{OSS}$	Output charge	$V_{DS} = 17\text{ V}, V_{GS} = 0\text{ V}$	9.7			28			nC
$t_{d(on)}$	Turnon delay time		7			8			ns
$t_r$	Rise time	$V_{DS} = 15\text{ V}, V_{GS} = 4.5\text{ V},$ $I_{DS} = 20\text{ A}, R_G = 2\ \Omega$	17			10			ns
$t_{d(off)}$	Turnoff delay time		13			33			ns
$t_f$	Fall time		2.3			4.7			ns
<b>DIODE CHARACTERISTICS</b>									
$V_{SD}$	Diode forward voltage	$I_{DS} = 20\text{ A}, V_{GS} = 0\text{ V}$	0.85 1			0.77 1			V
$Q_{rr}$	Reverse recovery charge	$V_{dd} = 17\text{ V}, I_F = 20\text{ A},$ $di/dt = 300\text{ A}/\mu\text{s}$	12.5			32			nC
$t_{rr}$	Reverse recovery time		22			28			ns

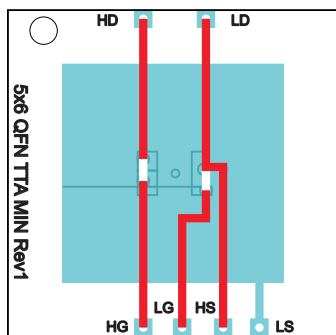
 (1) Equivalent based on application testing. See [Equivalent System Performance](#) section for details.

Max  $R_{\theta JA} = 50^\circ\text{C}/\text{W}$   
when mounted on 1 in<sup>2</sup>  
(6.45 cm<sup>2</sup>) of  
2-oz (0.071-mm) thick  
Cu.

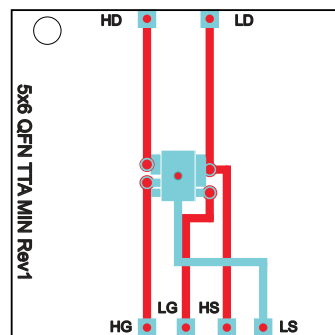

Max  $R_{\theta JA} = 102^\circ\text{C}/\text{W}$   
when mounted on  
minimum pad area of  
2-oz (0.071-mm) thick  
Cu.

### 5.6 Typical Power Block Device Characteristics

$T_J = 125^\circ\text{C}$ , unless stated otherwise. The typical power block system characteristic curves [Figure 3](#), [Figure 4](#), and [Figure 5](#) are based on measurements made on a PCB design with dimensions of 4 in (W) × 3.5 in (L) × 0.062 in (H) and 6 copper layers of 1-oz copper thickness. See [Application and Implementation](#) for detailed explanation.

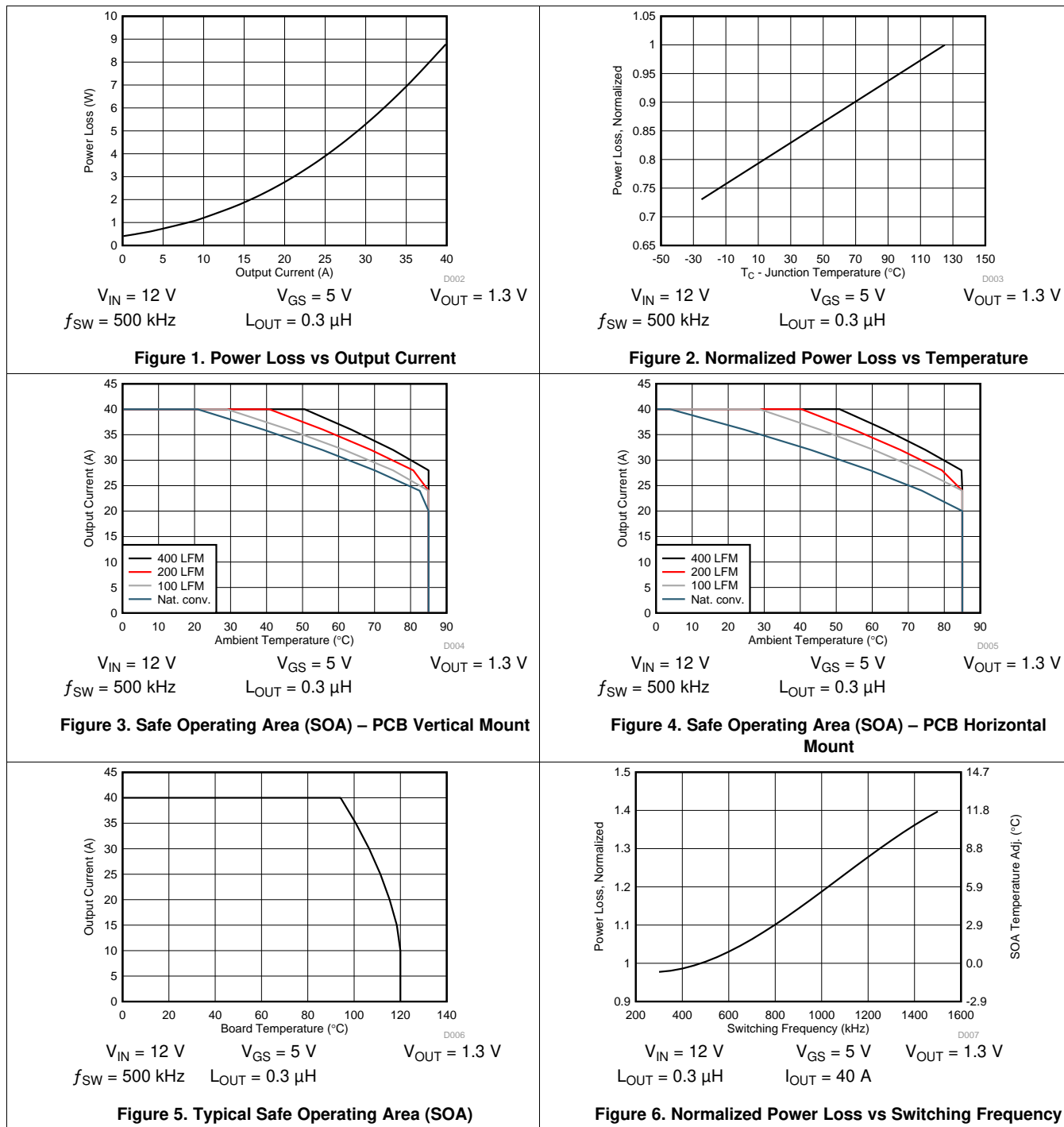

### Typical Power Block Device Characteristics (continued)

$T_J = 125^\circ\text{C}$ , unless stated otherwise. The typical power block system characteristic curves [Figure 3](#), [Figure 4](#), and [Figure 5](#) are based on measurements made on a PCB design with dimensions of 4 in (W) × 3.5 in (L) × 0.062 in (H) and 6 copper layers of 1-oz copper thickness. See [Application and Implementation](#) for detailed explanation.

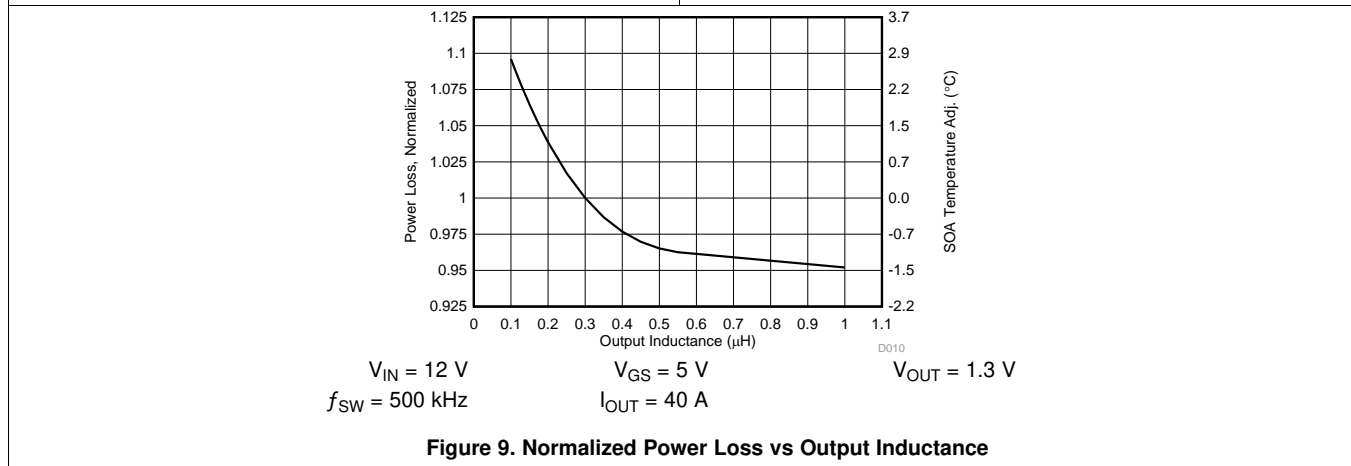
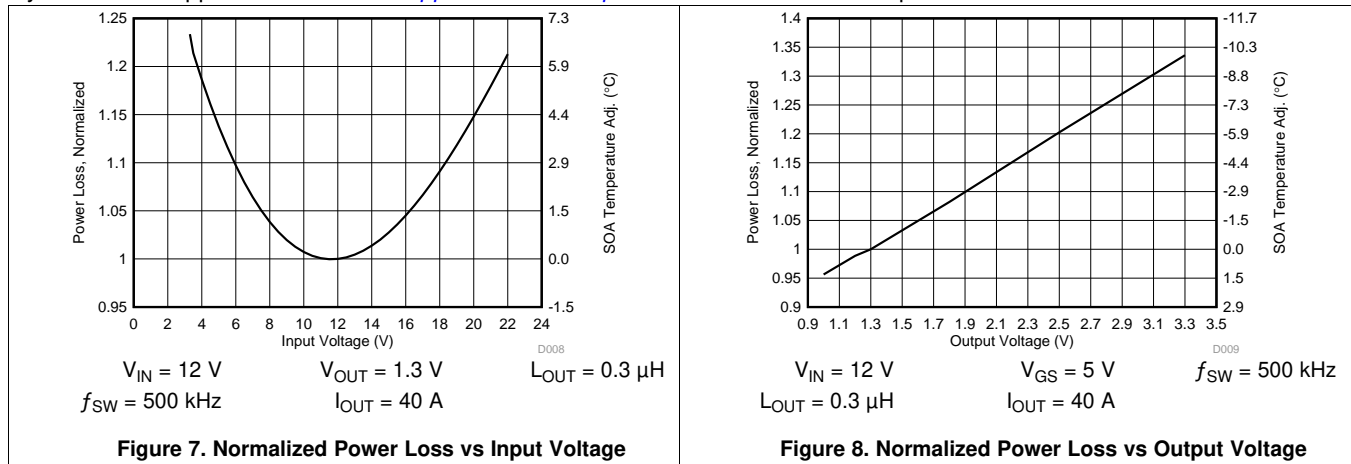

## 5.7 Typical Power Block MOSFET Characteristics

$T_A = 25^\circ\text{C}$ , unless stated otherwise.

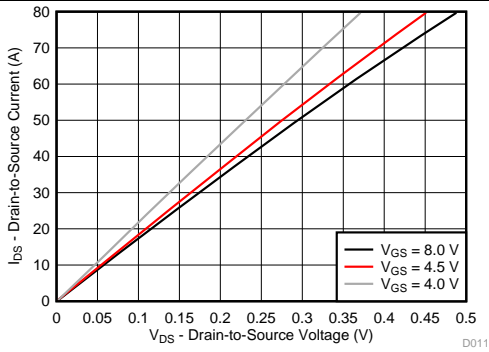

Figure 10. Control MOSFET Saturation

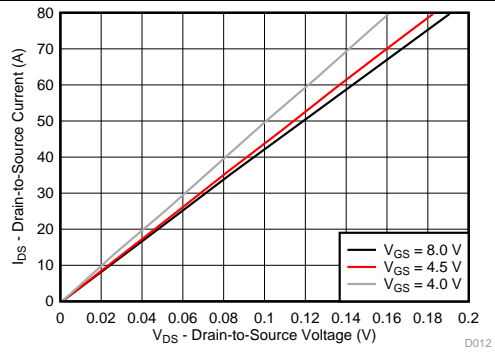

Figure 11. Sync MOSFET Saturation

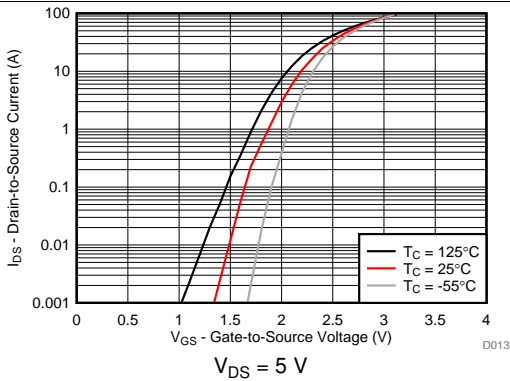

Figure 12. Control MOSFET Transfer

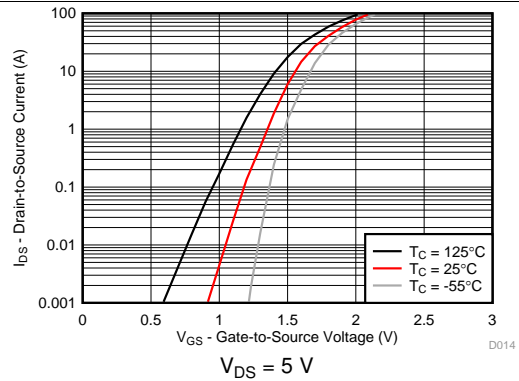

Figure 13. Sync MOSFET Transfer

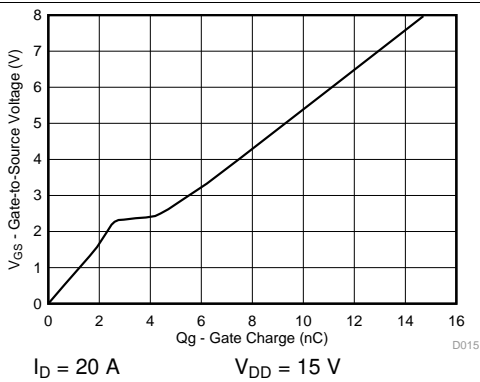

Figure 14. Control MOSFET Gate Charge

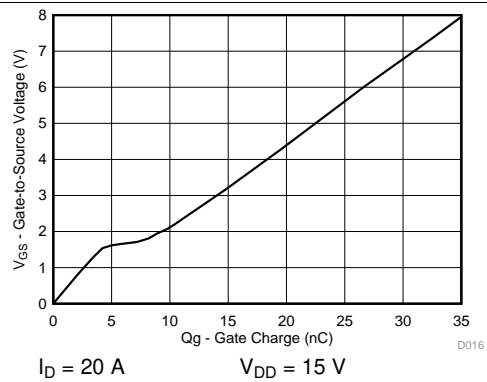

Figure 15. Sync MOSFET Gate Charge

Typical Power Block MOSFET Characteristics (continued)

$T_A = 25^\circ\text{C}$ , unless stated otherwise.

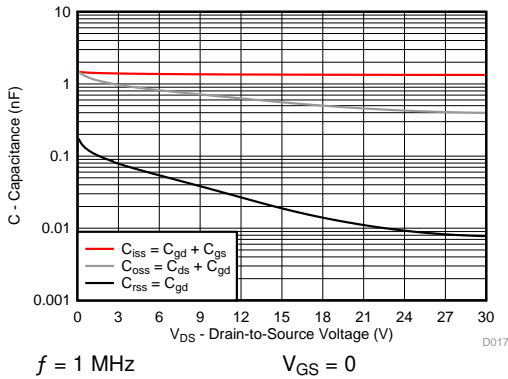

Figure 16. Control MOSFET Capacitance

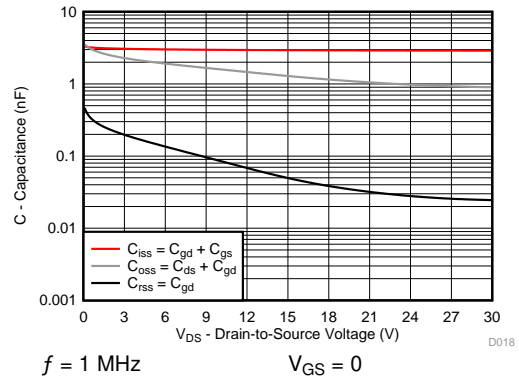

Figure 17. Sync MOSFET Capacitance

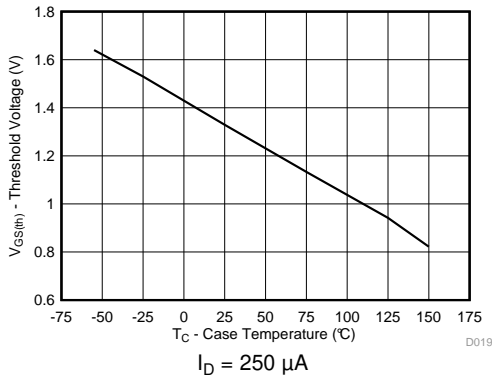

Figure 18. Control MOSFET  $V_{GS(th)}$

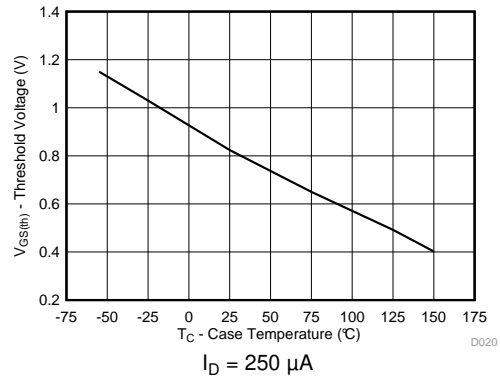

Figure 19. Sync MOSFET  $V_{GS(th)}$

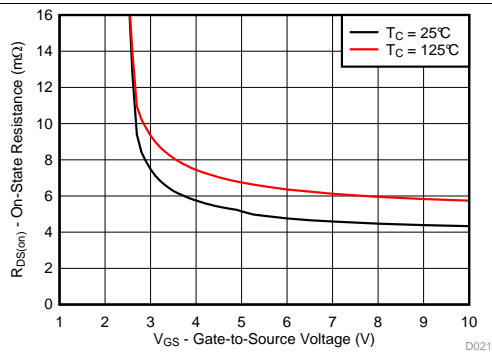

Figure 20. Control MOSFET  $R_{DS(on)}$  vs  $V_{GS}$

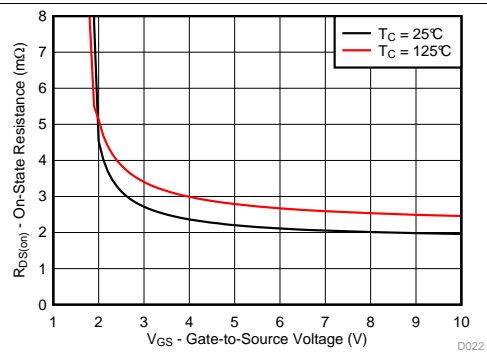

Figure 21. Sync MOSFET  $R_{DS(on)}$  vs  $V_{GS}$



Typical Power Block MOSFET Characteristics (continued)

$T_A = 25^\circ\text{C}$ , unless stated otherwise.

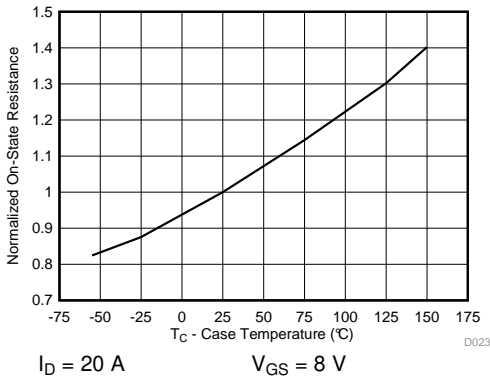

Figure 22. Control MOSFET Normalized  $R_{DS(on)}$

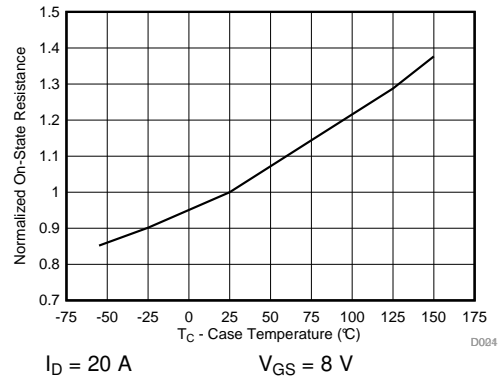

Figure 23. Sync MOSFET Normalized  $R_{DS(on)}$

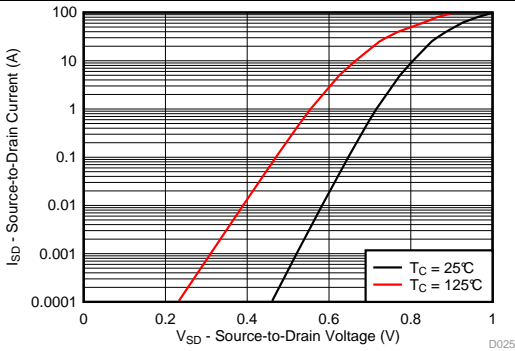

Figure 24. Control MOSFET Body Diode

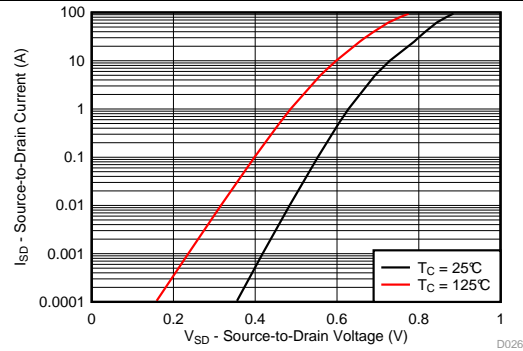

Figure 25. Sync MOSFET Body Diode

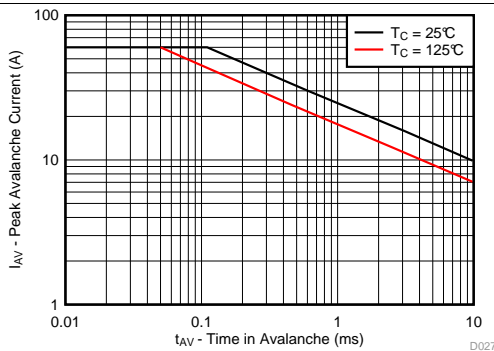

Figure 26. Control MOSFET Unclamped Inductive Switching

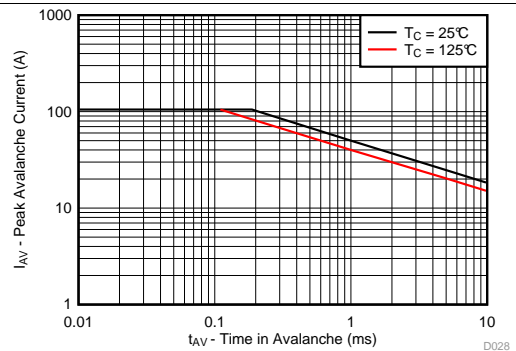

Figure 27. Sync MOSFET Unclamped Inductive Switching

## 6 Application and Implementation

### NOTE

Information in the following applications sections is not part of the TI component specification, and TI does not warrant its accuracy or completeness. TI's customers are responsible for determining suitability of components for their purposes. Customers should validate and test their design implementation to confirm system functionality.

### 6.1 Application Information

The CSD87350Q5D NexFET power block is an optimized design for synchronous buck applications using 5-V gate drive. The control FET and sync FET silicon are parametrically tuned to yield the lowest power loss and highest system efficiency. As a result, a new rating method is needed which is tailored towards a more systems-centric environment. System-level performance curves such as power loss, Safe Operating Area (SOA), and normalized graphs allow engineers to predict the product performance in the actual application.

#### 6.1.1 Equivalent System Performance

Many of today's high-performance computing systems require low-power consumption in an effort to reduce system operating temperatures and improve overall system efficiency. This has created a major emphasis on improving the conversion efficiency of today's synchronous buck topology. In particular, there has been an emphasis in improving the performance of the critical power semiconductor in the power stage of this application (see [Figure 28](#)). As such, optimization of the power semiconductors in these applications, needs to go beyond simply reducing  $R_{DS(ON)}$ .

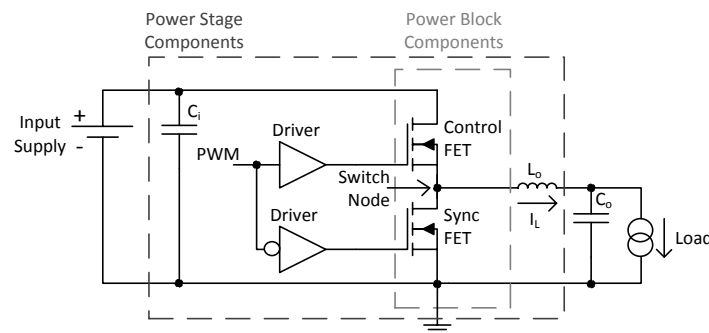

**Figure 28. Equivalent System Schematic**

The CSD87350Q5D is part of TI's power block product family which is a highly optimized product for use in a synchronous buck topology requiring high current, high efficiency, and high frequency. It incorporates TI's latest generation silicon which has been optimized for switching performance, as well as minimizing losses associated with  $Q_{GD}$ ,  $Q_{GS}$ , and  $Q_{RR}$ . Furthermore, TI's patented packaging technology has minimized losses by nearly eliminating parasitic elements between the control FET and sync FET connections (see [Figure 29](#)). A key challenge solved by TI's patented packaging technology is the system level impact of Common Source Inductance (CSI). CSI greatly impedes the switching characteristics of any MOSFET which in turn increases switching losses and reduces system efficiency. As a result, the effects of CSI need to be considered during the MOSFET selection process. In addition, standard MOSFET switching loss equations used to predict system efficiency need to be modified in order to account for the effects of CSI. Further details behind the effects of CSI and modification of switching loss equations are outlined in [Power Loss Calculation With Common Source Inductance Consideration for Synchronous Buck Converters](#) (SLPA009).

Application Information (continued)

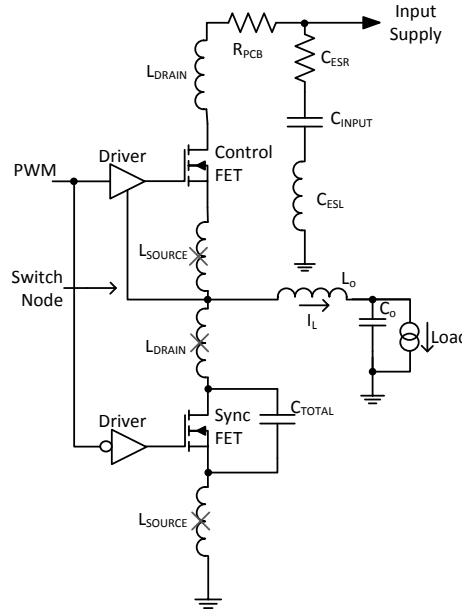
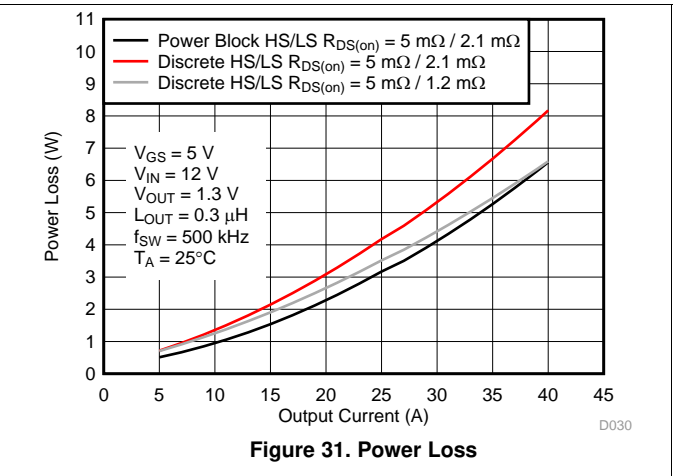
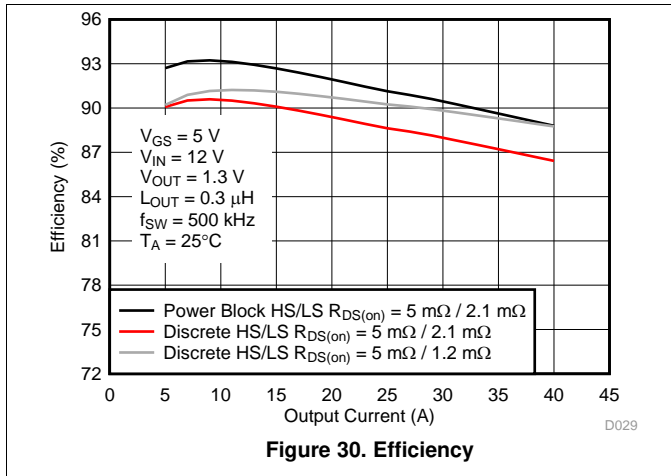

Figure 29. Elimination of Parasitic Inductances

The combination of TI's latest generation silicon and optimized packaging technology has created a benchmarking solution that outperforms industry standard MOSFET chipsets of similar  $R_{DS(ON)}$  and MOSFET chipsets with lower  $R_{DS(ON)}$ . Figure 30 and Figure 31 compare the efficiency and power loss performance of the CSD87350Q5D versus industry standard MOSFET chipsets commonly used in this type of application. This comparison purely focuses on the efficiency and generated loss of the power semiconductors only. The performance of CSD87350Q5D clearly highlights the importance of considering the Effective AC On-Impedance ( $Z_{DS(ON)}$ ) during the MOSFET selection process of any new design. Simply normalizing to traditional MOSFET  $R_{DS(ON)}$  specifications is not an indicator of the actual in-circuit performance when using TI's power block technology.



## Application Information (continued)

**Table 1** compares the traditional DC measured  $R_{DS(ON)}$  of CSD87350Q5D versus its  $Z_{DS(ON)}$ . This comparison takes into account the improved efficiency associated with TI's patented packaging technology. As such, when comparing TI's power block products to individually packaged discrete MOSFETs or dual MOSFETs in a standard package, the in-circuit switching performance of the solution must be considered. In this example, individually packaged discrete MOSFETs or dual MOSFETs in a standard package would need to have DC measured  $R_{DS(ON)}$  values that are equivalent to CSD87350Q5D's  $Z_{DS(ON)}$  value in order to have the same efficiency performance at full load. Mid- to light-load efficiency will still be lower with individually packaged discrete MOSFETs or dual MOSFETs in a standard package.

**Table 1. Comparison of  $R_{DS(ON)}$  vs  $Z_{DS(ON)}$**

PARAMETER	HS		LS		UNIT
	TYP	MAX	TYP	MAX	
Effective AC on-impedance $Z_{DS(ON)}$ ( $V_{GS} = 5\text{ V}$ )	5	–	1.2	–	mΩ
DC measured $R_{DS(ON)}$ ( $V_{GS} = 4.5\text{ V}$ )	5	6.8	2.1	2.8	

### 6.1.2 Power Loss Curves

MOSFET centric parameters such as  $R_{DS(ON)}$  and  $Q_{gd}$  are needed to estimate the loss generated by the devices. In an effort to simplify the design process for engineers, Texas Instruments has provided measured power loss performance curves. **Figure 1** plots the power loss of the CSD87350Q5D as a function of load current. This curve is measured by configuring and running the CSD87350Q5D as it would be in the final application (see **Figure 32**). The measured power loss is the CSD87350Q5D loss and consists of both input conversion loss and gate drive loss. **Equation 1** is used to generate the power loss curve.

$$(V_{IN} \times I_{IN}) + (V_{DD} \times I_{DD}) - (V_{SW\_AVG} \times I_{OUT}) = \text{power loss} \quad (1)$$

The power loss curve in **Figure 1** is measured at the maximum recommended junction temperatures of 125°C under isothermal test conditions.

### 6.1.3 Safe Operating Area (SOA) Curves

The SOA curves in the CSD87350Q5D data sheet provides guidance on the temperature boundaries within an operating system by incorporating the thermal resistance and system power loss. **Figure 3** to **Figure 5** outline the temperature and airflow conditions required for a given load current. The area under the curve dictates the safe operating area. All the curves are based on measurements made on a PCB design with dimensions of 4 in (W) × 3.5 in (L) × 0.062 in (T) and 6 copper layers of 1-oz copper thickness.

### 6.1.4 Normalized Curves

The normalized curves in the CSD87350Q5D data sheet provides guidance on the power loss and SOA adjustments based on their application specific needs. These curves show how the power loss and SOA boundaries will adjust for a given set of system conditions. The primary Y-axis is the normalized change in power loss and the secondary Y-axis is the change in system temperature required in order to comply with the SOA curve. The change in power loss is a multiplier for the power loss curve and the change in temperature is subtracted from the SOA curve.

## 6.2 Typical Application

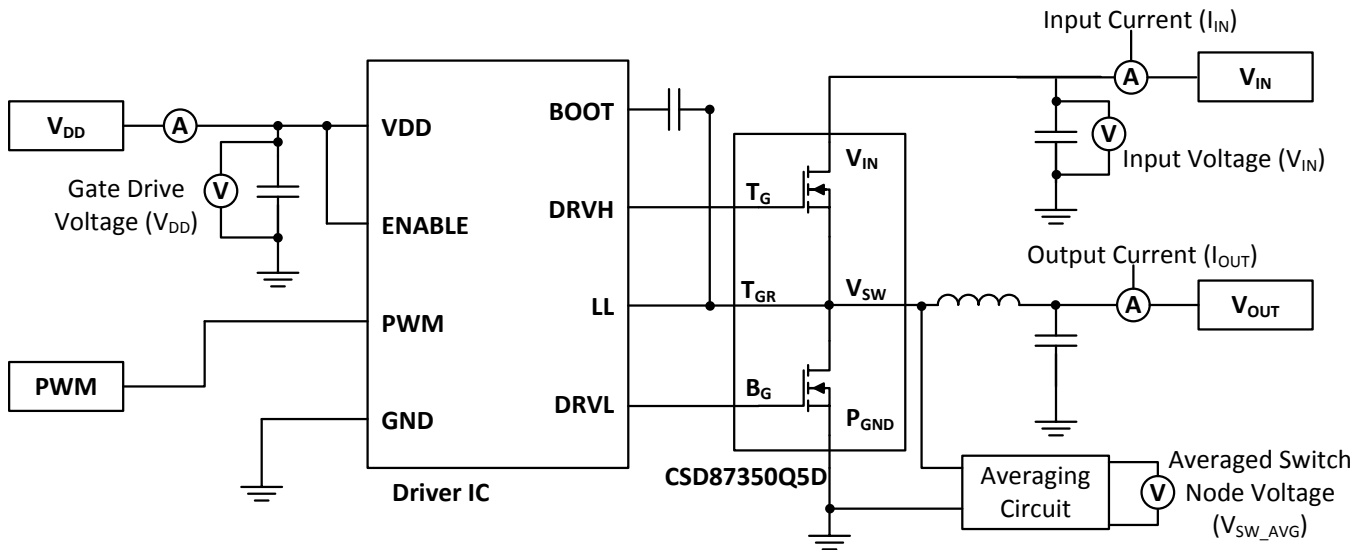

Figure 32.

### 6.2.1 Design Example: Calculating Power Loss and SOA

The user can estimate product loss and SOA boundaries by arithmetic means (see [Operating Conditions](#)). Though the power loss and SOA curves in this data sheet are taken for a specific set of test conditions, the following procedure will outline the steps the user should take to predict product performance for any set of system conditions.

#### 6.2.2 Operating Conditions

- Output current = 25 A
- Input voltage = 7 V
- Output voltage = 1 V
- Switching frequency = 800 kHz
- Inductor = 0.2  $\mu$ H

##### 6.2.2.1 Calculating Power Loss

- Power Loss at 25 A = 3.5 W ([Figure 1](#))
- Normalized Power Loss for input voltage  $\approx 1.07$  ([Figure 7](#))
- Normalized Power Loss for output voltage  $\approx 0.95$  ([Figure 8](#))
- Normalized Power Loss for switching frequency  $\approx 1.11$  ([Figure 6](#))
- Normalized Power Loss for output inductor  $\approx 1.07$  ([Figure 9](#))
- **Final calculated Power Loss = 3.5 W  $\times$  1.07  $\times$  0.95  $\times$  1.11  $\times$  1.07  $\approx$  4.23 W**

##### 6.2.2.2 Calculating SOA Adjustments

- SOA adjustment for input voltage  $\approx 2^\circ\text{C}$  ([Figure 7](#))
- SOA adjustment for output voltage  $\approx -1.3^\circ\text{C}$  ([Figure 8](#))
- SOA adjustment for switching frequency  $\approx 2.8^\circ\text{C}$  ([Figure 6](#))
- SOA adjustment for output inductor  $\approx 1.6^\circ\text{C}$  ([Figure 9](#))
- **Final calculated SOA adjustment = 2 + (-1.3) + 2.8 + 1.6  $\approx$  5.1 $^\circ\text{C}$**

In the previous design example, the estimated power loss of the CSD87350Q5D would increase to 4.23 W. In addition, the maximum allowable board and/or ambient temperature would have to decrease by 5.1 $^\circ\text{C}$ . [Figure 33](#) graphically shows how the SOA curve would be adjusted accordingly.

1. Start by drawing a horizontal line from the application current to the SOA curve.

**Typical Application (continued)**

2. Draw a vertical line from the SOA curve intercept down to the board/ambient temperature.
3. Adjust the SOA board/ambient temperature by subtracting the temperature adjustment value.

In the design example, the SOA temperature adjustment yields a reduction in allowable board/ambient temperature of 5.1°C. In the event the adjustment value is a negative number, subtracting the negative number would yield an increase in allowable board/ambient temperature.

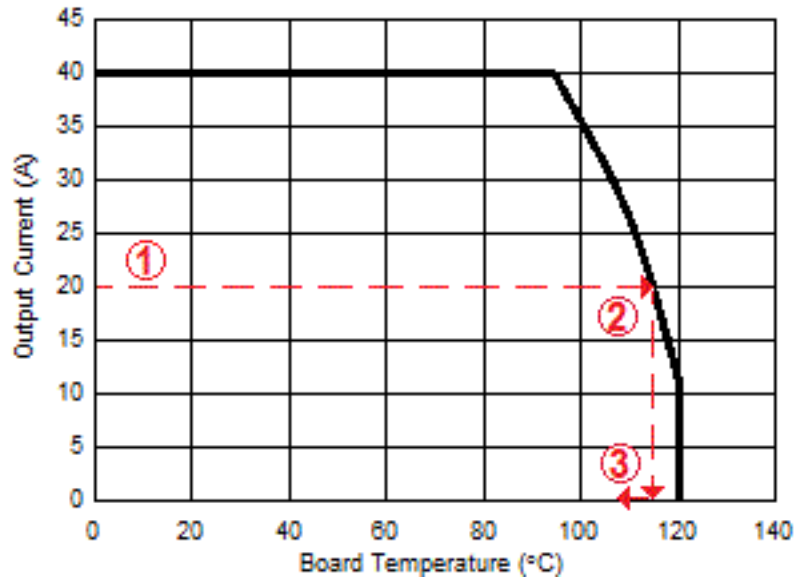

**Figure 33. Power Block SOA**

## 7 Layout

### 7.1 Layout Guidelines

There are two key system-level parameters that can be addressed with a proper PCB design: electrical and thermal performance. Properly optimizing the PCB layout will yield maximum performance in both areas. The following sections provide a brief description on how to address each parameter.

#### 7.1.1 Electrical Performance

The power block has the ability to switch voltages at rates greater than 10kV/μs. Take special care with the PCB layout design and placement of the input capacitors, driver IC, and output inductor.

- The placement of the input capacitors relative to the power block's VIN and PGND pins should have the highest priority during the component placement routine. It is critical to minimize these node lengths. As such, ceramic input capacitors need to be placed as close as possible to the VIN and PGND pins (see [Figure 34](#)). The example in [Figure 34](#) uses 6 × 10-μF ceramic capacitors (TDK Part C3216X5R1C106KT or equivalent). Notice there are ceramic capacitors on both sides of the board with an appropriate amount of vias interconnecting both layers. In terms of priority of placement next to the power block, C5, C7, C19, and C8 should follow in order.
- The driver IC should be placed relatively close to the power block gate pins. T<sub>G</sub> and B<sub>G</sub> should connect to the outputs of the driver IC. The T<sub>GR</sub> pin serves as the return path of the high-side gate drive circuitry and should be connected to the phase pin of the IC (sometimes called LX, LL, SW, PH, etc.). The bootstrap capacitor for the driver IC will also connect to this pin.
- The switching node of the output inductor should be placed relatively close to the power block VSW pins. Minimizing the node length between these two components will reduce the PCB conduction losses and actually reduce the switching noise level.
- In the event the switch node waveform exhibits ringing that reaches undesirable levels, the use of a boost resistor or RC snubber can be an effective way to reduce the peak ring level. The recommended boost resistor value will range between 1 Ω to 4.7 Ω depending on the output characteristics of driver IC used in conjunction with the power block. The RC snubber values can range from 0.5 Ω to 2.2 Ω for the R and 330 pF to 2200 pF for the C. Refer to [Snubber Circuits: Theory, Design and Application](#) (SLUP100) for more details on how to properly tune the RC snubber values. The RC snubber should be placed as close as possible to the Vsw node and PGND see [Figure 34](#). <sup>(1)</sup>

#### 7.1.2 Thermal Considerations

The power block has the ability to use the GND planes as the primary thermal path. As such, the use of thermal vias is an effective way to pull away heat from the device and into the system board. Concerns of solder voids and manufacturability problems can be addressed by the use of three basic tactics to minimize the amount of solder attach that will wick down the via barrel:

- Intentionally space out the vias from each other to avoid a cluster of holes in a given area.
- Use the smallest drill size allowed in your design. The example in [Figure 34](#) uses vias with a 10-mil drill hole and a 16-mil capture pad.
- Tent the opposite side of the via with solder-mask.

In the end, the number and drill size of the thermal vias should align with the end user's PCB design rules and manufacturing capabilities.

(1) Keong W. Kam, David Pommerenke, "EMI Analysis Methods for Synchronous Buck Converter EMI Root Cause Analysis", University of Missouri – Rolla

## 7.2 Layout Example

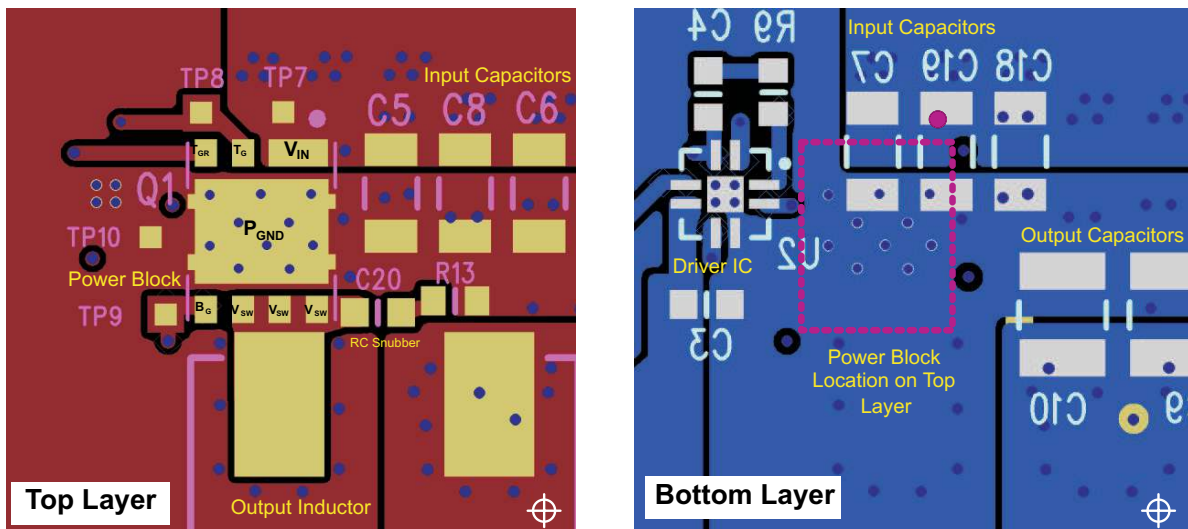

Figure 34. Recommended PCB Layout (Top View)



## 8 Device and Documentation Support

### 8.1 Documentation Support

#### 8.1.1 Related Documentation

For related documentation see the following:

- [Reducing Ringing Through PCB Layout Techniques](#)
- [Power Loss Calculation With Common Source Inductance Consideration for Synchronous Buck Converters](#)
- [Snubber Circuits: Theory , Design and Application](#)

### 8.2 Receiving Notification of Documentation Updates

To receive notification of documentation updates, navigate to the device product folder on ti.com. In the upper right corner, click on *Alert me* to register and receive a weekly digest of any product information that has changed. For change details, review the revision history included in any revised document.

### 8.3 Community Resources

The following links connect to TI community resources. Linked contents are provided "AS IS" by the respective contributors. They do not constitute TI specifications and do not necessarily reflect TI's views; see TI's [Terms of Use](#).

**TI E2E™ Online Community** *TI's Engineer-to-Engineer (E2E) Community*. Created to foster collaboration among engineers. At e2e.ti.com, you can ask questions, share knowledge, explore ideas and help solve problems with fellow engineers.

**Design Support** *TI's Design Support* Quickly find helpful E2E forums along with design support tools and contact information for technical support.

### 8.4 Trademarks

NexFET, E2E are trademarks of Texas Instruments.  
All other trademarks are the property of their respective owners.

### 8.5 Electrostatic Discharge Caution



These devices have limited built-in ESD protection. The leads should be shorted together or the device placed in conductive foam during storage or handling to prevent electrostatic damage to the MOS gates.

### 8.6 Glossary

**SLYZ022** — *TI Glossary*.

This glossary lists and explains terms, acronyms, and definitions.

## 9 Mechanical, Packaging, and Orderable Information

The following pages include mechanical, packaging, and orderable information. This information is the most current data available for the designated devices. This data is subject to change without notice and revision of this document. For browser-based versions of this data sheet, refer to the left-hand navigation.

### 9.1 Q5D Package Dimensions

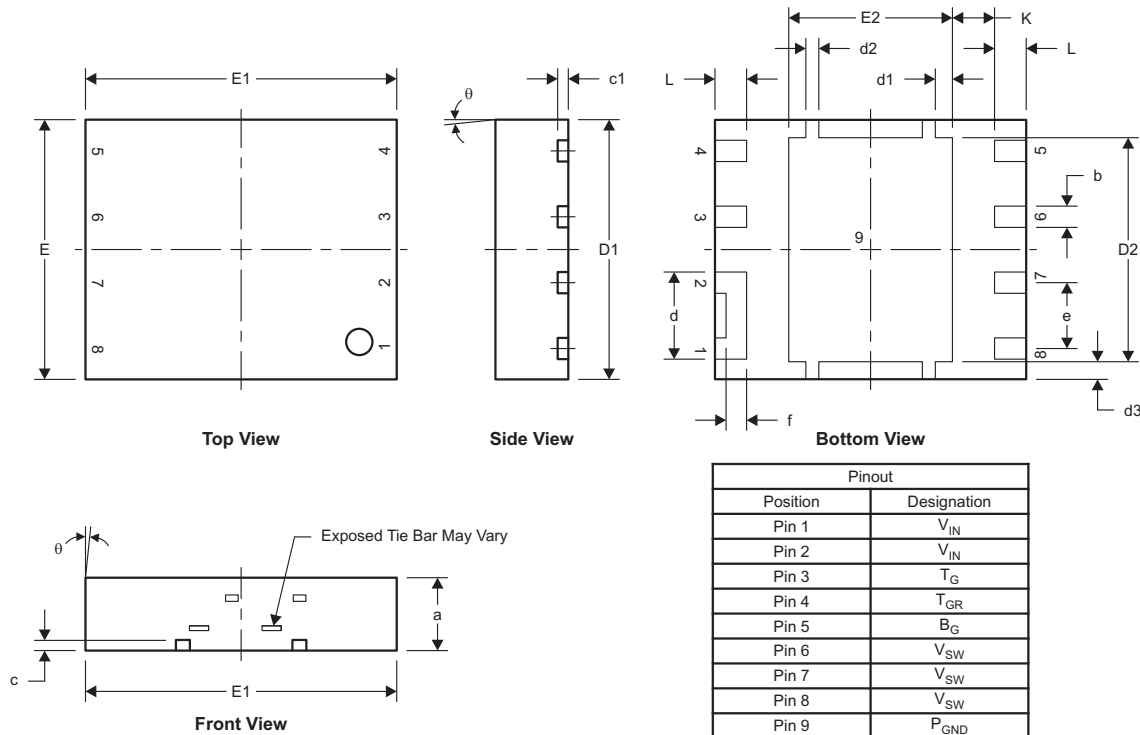

M0187-01

DIM	MILLIMETERS		INCHES	
	MIN	MAX	MIN	MAX
a	1.40	1.5	0.055	0.059
b	0.360	0.460	0.014	0.018
c	0.150	0.250	0.006	0.010
c1	0.150	0.250	0.006	0.010
d	1.630	1.730	0.064	0.068
d1	0.280	0.380	0.011	0.015
d2	0.200	0.300	0.008	0.012
d3	0.291	0.391	0.012	0.015
D1	4.900	5.100	0.193	0.201
D2	4.269	4.369	0.168	0.172
E	4.900	5.100	0.193	0.201
E1	5.900	6.100	0.232	0.240
E2	3.106	3.206	0.122	0.126
e	1.27 TYP		0.050	
f	0.396	0.496	0.016	0.020
L	0.510	0.710	0.020	0.028
theta	0.00		—	
K	0.812		0.032	



## 9.4 Q5D Tape and Reel Information

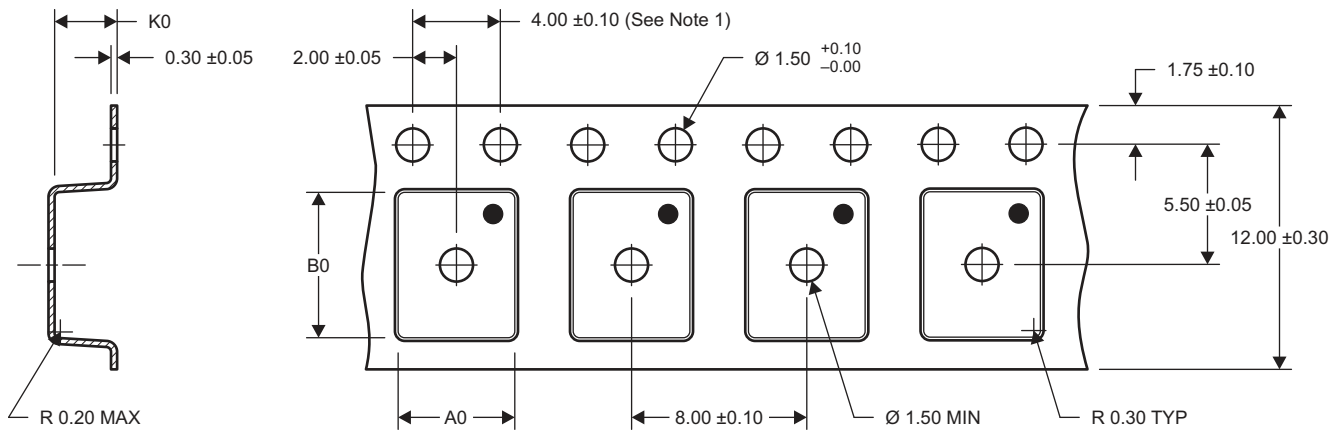

$A0 = 5.30 \pm 0.10$   
 $B0 = 6.50 \pm 0.10$   
 $K0 = 1.90 \pm 0.10$

M0191-01

- NOTES:
1. 10-sprocket hole-pitch cumulative tolerance  $\pm 0.2$ .
  2. Camber not to exceed 1 mm in 100 mm, noncumulative over 250 mm.
  3. Material: black static-dissipative polystyrene.
  4. All dimensions are in mm, unless otherwise specified.
  5. Thickness:  $0.3 \pm 0.05$  mm.
  6. MSL1 260°C (IR and convection) PbF-reflow compatible.

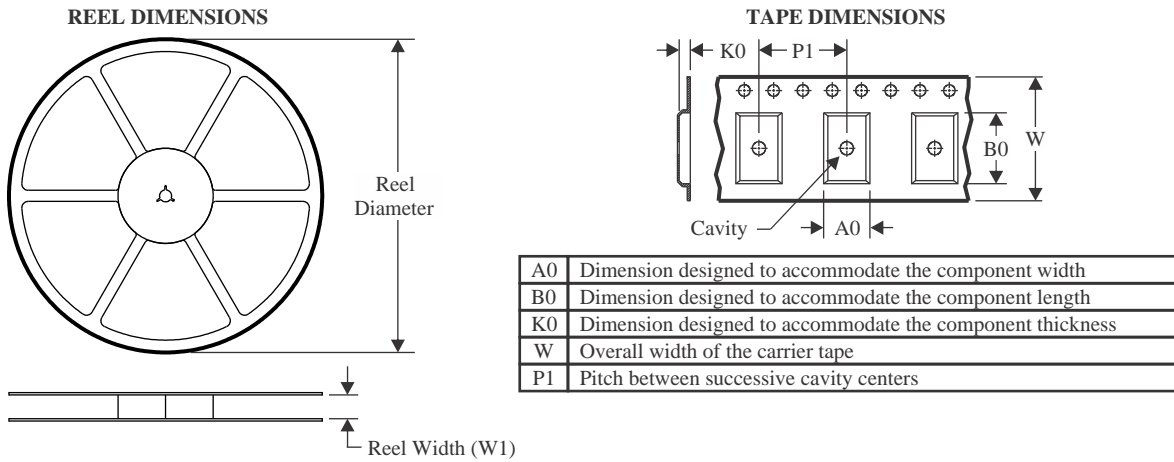
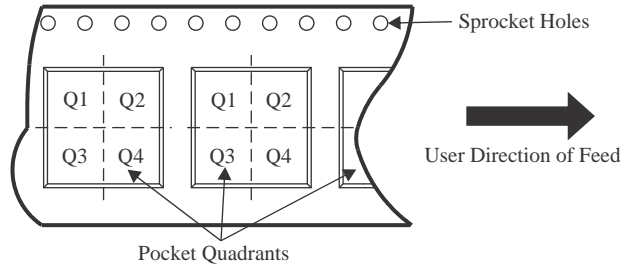
**TAPE AND REEL INFORMATION**

**QUADRANT ASSIGNMENTS FOR PIN 1 ORIENTATION IN TAPE**

\*All dimensions are nominal

Device	Package Type	Package Drawing	Pins	SPQ	Reel Diameter (mm)	Reel Width W1 (mm)	A0 (mm)	B0 (mm)	K0 (mm)	P1 (mm)	W (mm)	Pin1 Quadrant
CSD87350Q5D	LSON-CLIP	DQY	8	2500	330.0	12.4	5.3	6.3	1.8	8.0	12.0	Q2
CSD87350Q5D	LSON-CLIP	DQY	8	2500	330.0	15.4	5.3	6.3	1.8	8.0	12.0	Q2

**TAPE AND REEL BOX DIMENSIONS**

\*All dimensions are nominal

Device	Package Type	Package Drawing	Pins	SPQ	Length (mm)	Width (mm)	Height (mm)
CSD87350Q5D	LSON-CLIP	DQY	8	2500	346.0	346.0	33.0
CSD87350Q5D	LSON-CLIP	DQY	8	2500	335.0	335.0	32.0

## IMPORTANT NOTICE AND DISCLAIMER

TI PROVIDES TECHNICAL AND RELIABILITY DATA (INCLUDING DATA SHEETS), DESIGN RESOURCES (INCLUDING REFERENCE DESIGNS), APPLICATION OR OTHER DESIGN ADVICE, WEB TOOLS, SAFETY INFORMATION, AND OTHER RESOURCES "AS IS" AND WITH ALL FAULTS, AND DISCLAIMS ALL WARRANTIES, EXPRESS AND IMPLIED, INCLUDING WITHOUT LIMITATION ANY IMPLIED WARRANTIES OF MERCHANTABILITY, FITNESS FOR A PARTICULAR PURPOSE OR NON-INFRINGEMENT OF THIRD PARTY INTELLECTUAL PROPERTY RIGHTS.

These resources are intended for skilled developers designing with TI products. You are solely responsible for (1) selecting the appropriate TI products for your application, (2) designing, validating and testing your application, and (3) ensuring your application meets applicable standards, and any other safety, security, regulatory or other requirements.

These resources are subject to change without notice. TI grants you permission to use these resources only for development of an application that uses the TI products described in the resource. Other reproduction and display of these resources is prohibited. No license is granted to any other TI intellectual property right or to any third party intellectual property right. TI disclaims responsibility for, and you will fully indemnify TI and its representatives against, any claims, damages, costs, losses, and liabilities arising out of your use of these resources.

TI's products are provided subject to [TI's Terms of Sale](#) or other applicable terms available either on [ti.com](https://www.ti.com) or provided in conjunction with such TI products. TI's provision of these resources does not expand or otherwise alter TI's applicable warranties or warranty disclaimers for TI products.

TI objects to and rejects any additional or different terms you may have proposed.

Mailing Address: Texas Instruments, Post Office Box 655303, Dallas, Texas 75265  
Copyright © 2023, Texas Instruments Incorporated