

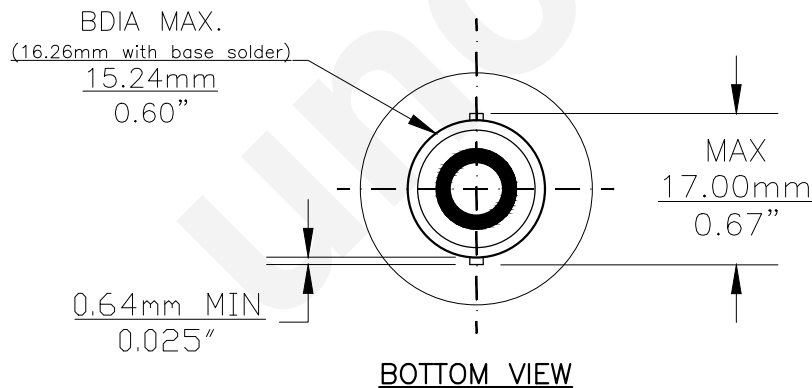

PART NO.	BASE TYPE	DESIGN VOLTS	DESIGN AMPS	MSCD	FILAMENT TYPE	AVERAGE LIFE HOURS	REVISIONS			
							REV #	DESCRIPTION	DATE	APPROVED
CE6	S.C. Bayonet (BA15s) (Nickel)	48.0V	0.20	--	C-5A	300	1	REDRAWN, ADDED 90° AND BOTTOM VIEWS	04/28/2016	R.M.

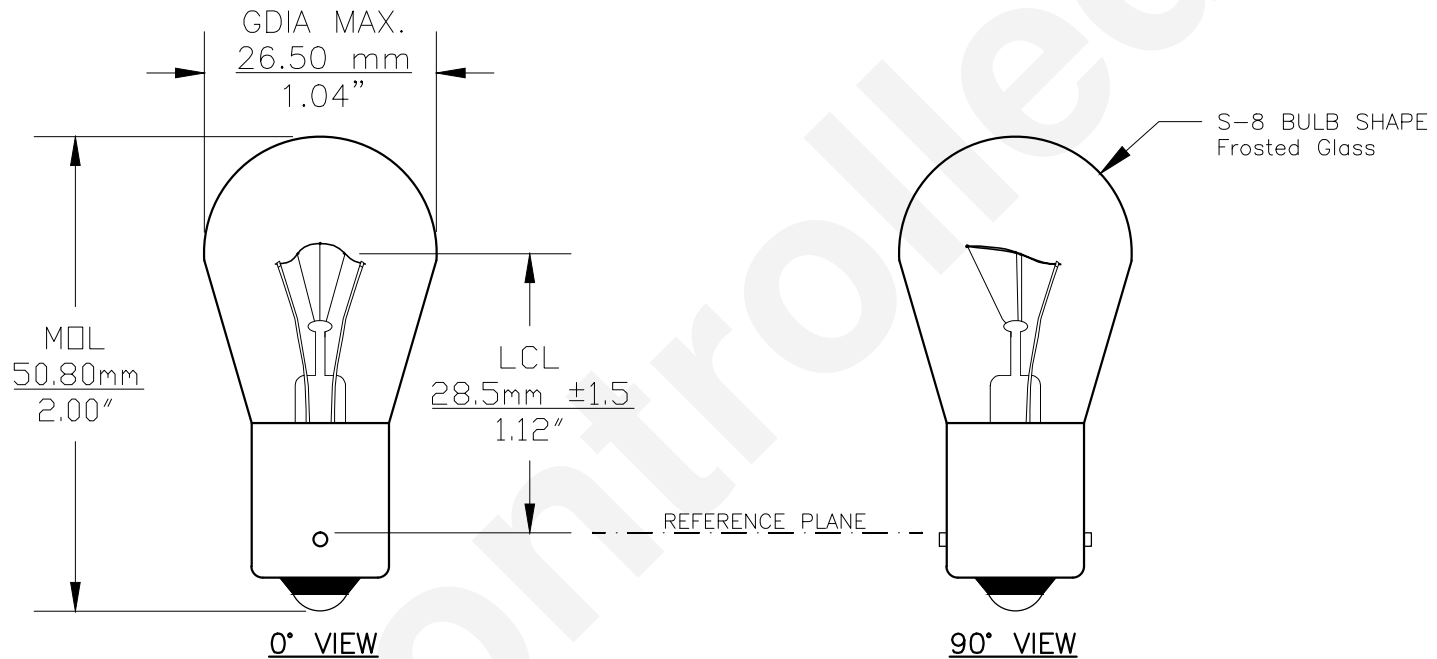

UNLESS OTHERWISE SPECIFIED: DIMENSIONS ARE IN INCHES TOLERANCES		CEC INDUSTRIES LTD			
DECIMALS	ANGULAR	599 BOND STREET		LINCOLNSHIRE, IL 60069	
.XX ± .05	± 0.5°	TITLE LIGHT BULB NO. CE6			
.XXX ± .010		SIZE A	FSCM NO.	DWG NO. CE6	REV 1
FRACTIONAL	± 1/64	SCALE	PLOT SCALE	SHEET 1 OF 1	
DRAWN D. C.		DATE 12/27/2004	MATERIAL		
CHECKED		FILE CE6.pdf	DRAWING NOT TO SCALE		