

APPROVED: _____
 DATE: _____ TITLE: _____

Rev	AWO #	Description	Date	Appr
-		RELEASED	11/1/22	
A		UPDATE SPEC.	11/30/22	WX/RC

Ⓐ Lock Nut

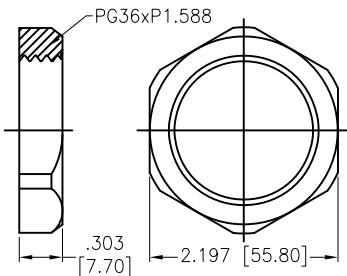

Ⓑ Washer

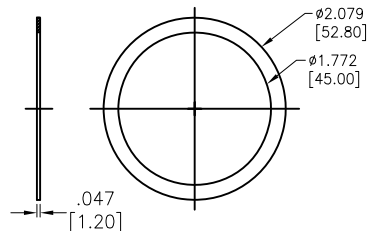

Ⓒ Body

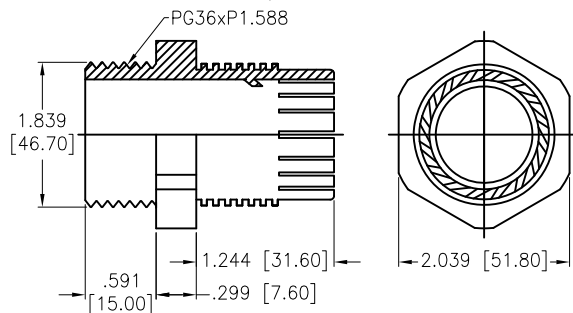

Ⓓ Seal

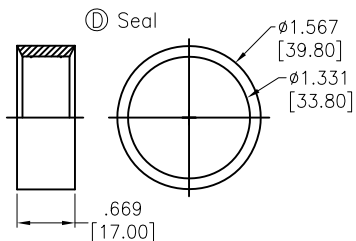

Ⓔ Sealing Nut

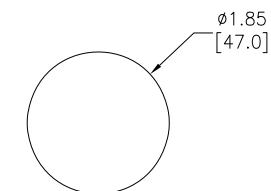
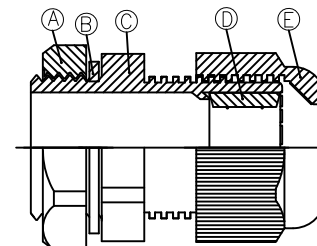
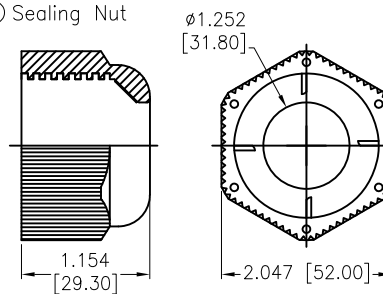

RECOMMENDED
 PANEL CUT-OUT
 (.240 [6.1] MAX PANEL THICKNESS)

SPECIFICATIONS:

Material:
 Lock Nut: PA66, rated UL 94V-2
 Body: PA66, rated UL 94V-2
 Sealing Nut: PA66, rated UL 94V-2
 Washer: Nitrile Butylene
 Seal: Nitrile Butylene
 Mechanical:
 Cable Range O.D.: 23-32 mm
 Thread O.D. L2: 47mm
 Thread Length L2: 15mm
 Spanner Size A&E: 56/52 mm
 Nut Torque: 3.5Nm Max.
 Environmental:
 Waterproof: IP68
 Lead free, RoHS compliant.



UNLESS OTHERWISE SPECIFIED ALL DIMENSIONS ARE INCHES [MM]. TOLERANCES: EXCEPT AS NOTED		
INCHES	HOLES	
.X ± .10	Ø.X ± .10	
.XX ± .020	Ø.XX ± .015	
.XXX ± .015	Ø.XXX ± .010	
DRAWN	JJ	11/1/22
CHECKED	RC	11/1/22
APPROVED		
THIS DRAWING CONTAINS INFORMATION THAT IS PROPRIETARY AND SHOULD NOT BE USED WITHOUT PRIOR WRITTEN PERMISSION FROM ADAM TECH		

	909 Rahway Avenue, Union, NJ 07083 Phone: 908-687-5000 Fax: 908-687-5710	
	TITLE WATERPROOF CONNECTOR, PG36, 1 HOLE, CABLE GLAND, WATERPROOF: IP68	
SIZE X	PART NO. CG-P-36	REV. A
REF: S00211C	SCALE: NTS	SHEET 1 OF 1