



PJQ5468A

60V N-Channel Enhancement Mode MOSFET

Voltage

60 V

Current

25 A

Features

- $R_{DS(ON)}$, $V_{GS}@10V, I_D@15A < 34m\Omega$
- $R_{DS(ON)}$, $V_{GS}@4.5V, I_D@10A < 40m\Omega$
- High switching speed
- Improved dv/dt capability
- Low reverse transfer capacitance
- Lead free in compliance with EU RoHS 2.0
- Green molding compound as per IEC 61249 standard

Mechanical Data

- Case: DFN5060-8L Package
- Terminals: Solderable per MIL-STD-750, Method 2026
- Approx. Weight: 0.0028 ounces, 0.08 grams
- Marking: Q5468A

DFN5060-8L

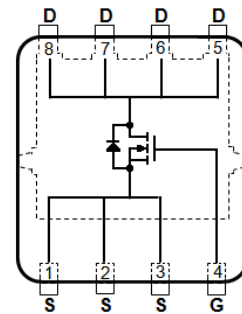
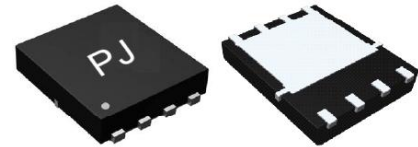

Maximum Ratings and Thermal Characteristics ($T_A=25^\circ\text{C}$ unless otherwise noted)

PARAMETER		SYMBOL	LIMIT	UNITS
Drain-Source Voltage		V_{DS}	60	V
Gate-Source Voltage		V_{GS}	± 20	V
Continuous Drain Current	$T_C=25^\circ\text{C}$	I_D	25	A
	$T_C=100^\circ\text{C}$		16	
Pulsed Drain Current ^(Note 1)	$T_C=25^\circ\text{C}$	I_{DM}	100	
Power Dissipation	$T_C=25^\circ\text{C}$	P_D	40	W
	$T_C=100^\circ\text{C}$		16	
Continuous Drain Current	$T_A=25^\circ\text{C}$	I_D	5.5	A
	$T_A=70^\circ\text{C}$		4.4	A
Power Dissipation	$T_A=25^\circ\text{C}$	P_D	2.0	W
Power Dissipation	$T_A=70^\circ\text{C}$		1.3	
Single Pulse Avalanche Energy ^(Note 6)		E_{AS}	24	mJ
Operating Junction and Storage Temperature Range		T_J, T_{STG}	-55~150	$^\circ\text{C}$
Typical Thermal Resistance ^(Note 4,5)	Junction to Case	$R_{\theta JC}$	3.1	$^\circ\text{C/W}$
	Junction to Ambient	$R_{\theta JA}$	62.5	

- Limited only By Maximum Junction Temperature



PJQ5468A

Electrical Characteristics ($T_A=25^\circ\text{C}$ unless otherwise noted)

PARAMETER	SYMBOL	TEST CONDITION	MIN.	TYP.	MAX.	UNITS
Static						
Drain-Source Breakdown Voltage	BV_{DSS}	$V_{GS}=0V, I_D=250\mu A$	60	-	-	V
Gate Threshold Voltage	$V_{GS(th)}$	$V_{DS}=V_{GS}, I_D=250\mu A$	1.0	1.83	2.5	V
Drain-Source On-State Resistance	$R_{DS(on)}$	$V_{GS}=10V, I_D=15A$	-	28	34	m Ω
		$V_{GS}=4.5V, I_D=10A$	-	33	40	
Zero Gate Voltage Drain Current	I_{DSS}	$V_{DS}=60V, V_{GS}=0V$	-	-	1.0	μA
Gate-Source Leakage Current	I_{GSS}	$V_{GS}=\pm 20V, V_{DS}=0V$	-	-	± 100	nA
Dynamic (Note 7)						
Total Gate Charge	Q_g	$V_{DS}=30V, I_D=20A,$ $V_{GS}=10V$ (Note 1,2)	-	20	-	nC
Gate-Source Charge	Q_{gs}		-	3.8	-	
Gate-Drain Charge	Q_{gd}		-	3.9	-	
Input Capacitance	C_{iss}	$V_{DS}=25V, V_{GS}=0V,$ $f=1.0\text{MHz}$	-	1173	-	pF
Output Capacitance	C_{oss}		-	63	-	
Reverse Transfer Capacitance	C_{rss}		-	44	-	
Turn-On Delay Time	$t_{d(on)}$	$V_{DD}=15V, I_D=1A,$ $V_{GS}=10V, R_G=6\Omega$ (Note 1,2)	-	7.1	-	ns
Turn-On Rise Time	t_r		-	25	-	
Turn-Off Delay Time	$t_{d(off)}$		-	31	-	
Turn-Off Fall Time	t_f		-	20	-	
Drain-Source Diode						
Maximum Continuous Drain-Source Diode Forward Current	I_S	---	-	-	25	A
Diode Forward Voltage	V_{SD}	$I_S=1A, V_{GS}=0V$	-	0.72	1.2	V

NOTES :

1. Pulse width $\leq 300\mu s$, Duty cycle $\leq 2\%$
2. Essentially independent of operating temperature typical characteristics.
3. Repetitive rating, pulse width limited by junction temperature $T_J(\text{MAX})=150^\circ\text{C}$. Ratings are based on low frequency and duty cycles to keep initial $T_J=25^\circ\text{C}$.
4. The maximum current rating is package limited.
5. $R_{\theta JA}$ is the sum of the junction-to-case and case-to-ambient thermal resistance where the case thermal reference is defined as the solder mounting surface of the drain pins. Mounted on a 1 inch² with 2oz. square pad of copper.
6. The test condition is $L=0.1\text{mH}$, $I_{AS}=22A$, $V_{DD}=25V$, $V_{GS}=10V$
7. Guaranteed by design, not subject to production testing.



PJQ5468A

TYPICAL CHARACTERISTIC CURVES

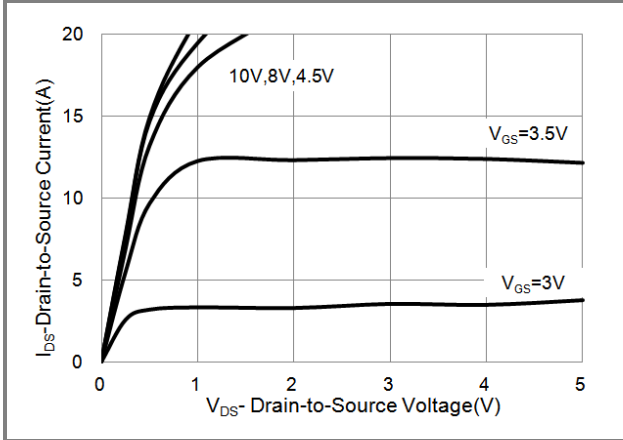

Fig.1 Output Characteristics

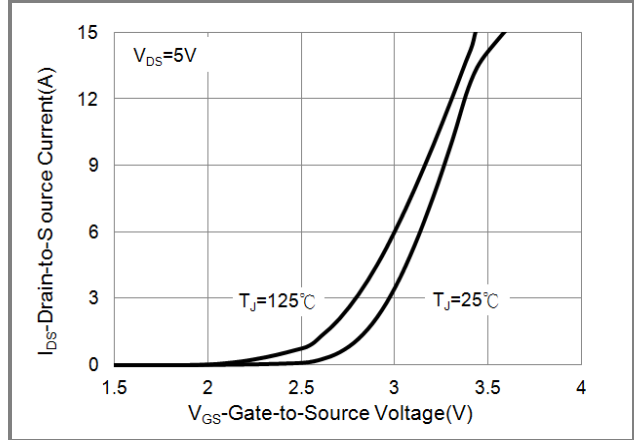

Fig.2 Transfer Characteristics

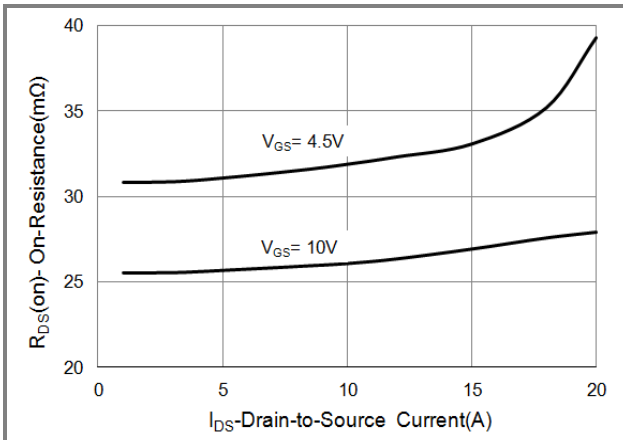

Fig.3 On-Resistance vs. Drain Current

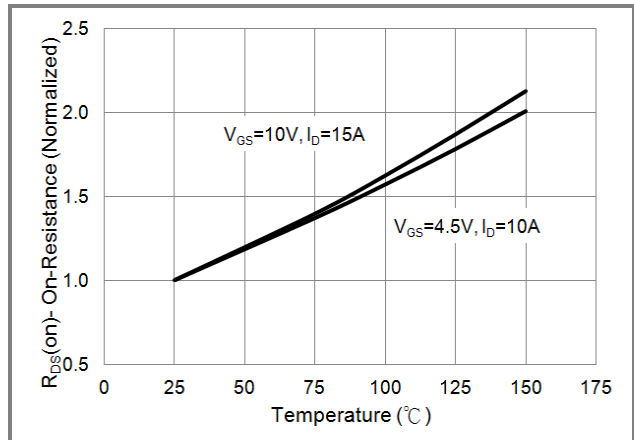

Fig.4 On-Resistance vs. Junction temperature

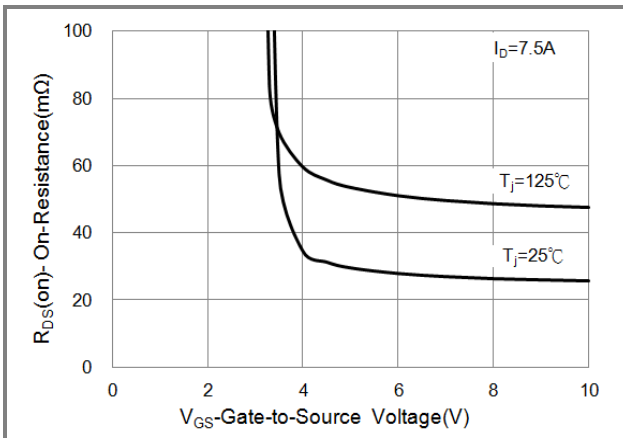

Fig.5 On-Resistance Variation with V_GS.

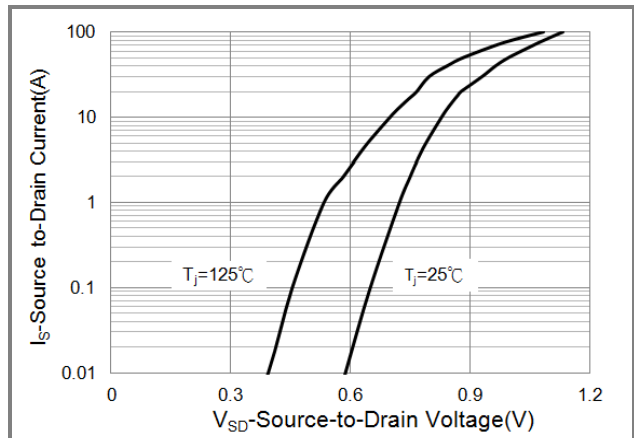

Fig.6 Source-Drain Diode Forward Voltage



PJQ5468A

TYPICAL CHARACTERISTIC CURVES

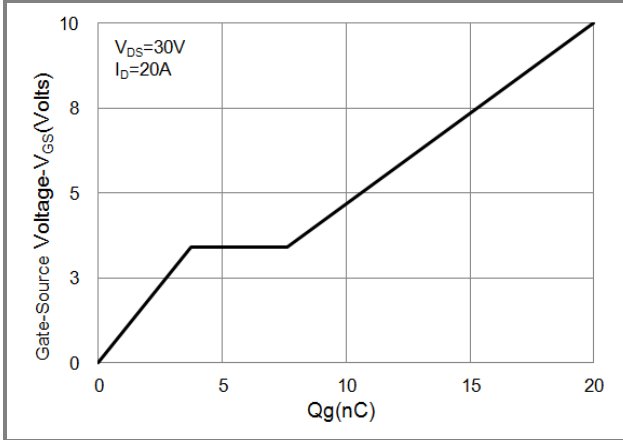

Fig.7 Gate-Charge Characteristics

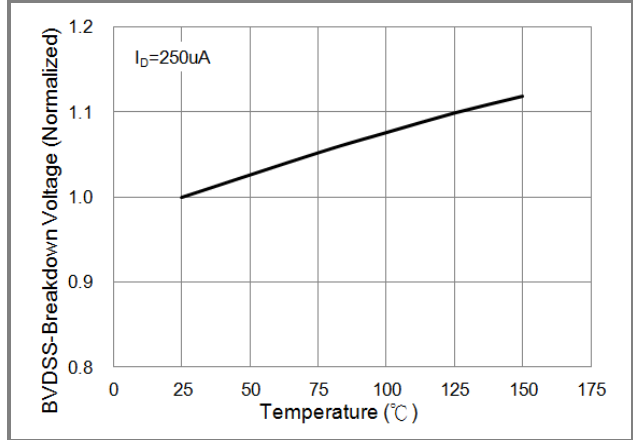

Fig.8 Breakdown Voltage Variation vs. Temperature

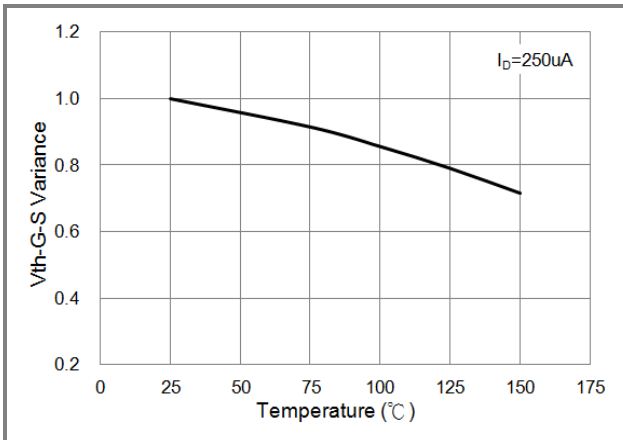

Fig.9 Threshold Voltage Variation with Temperature

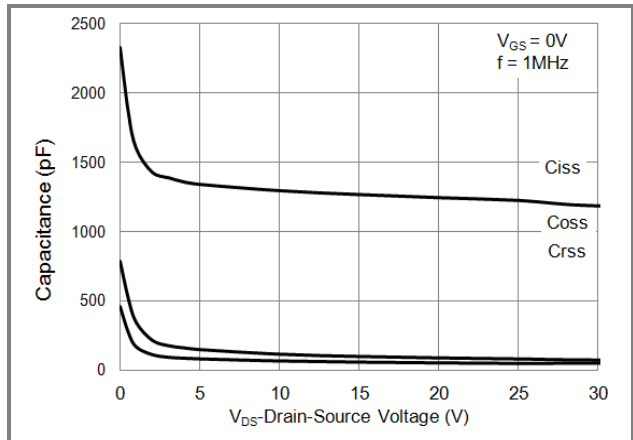

Fig.10 Capacitance vs. Drain-Source Voltage

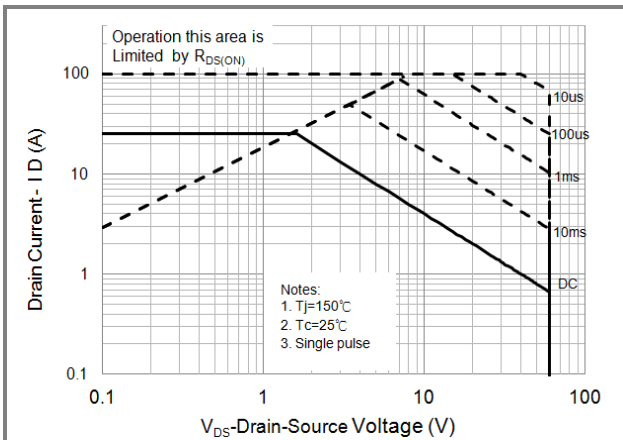

Fig.11 Maximum Safe Operating Area



PJQ5468A

TYPICAL CHARACTERISTIC CURVES

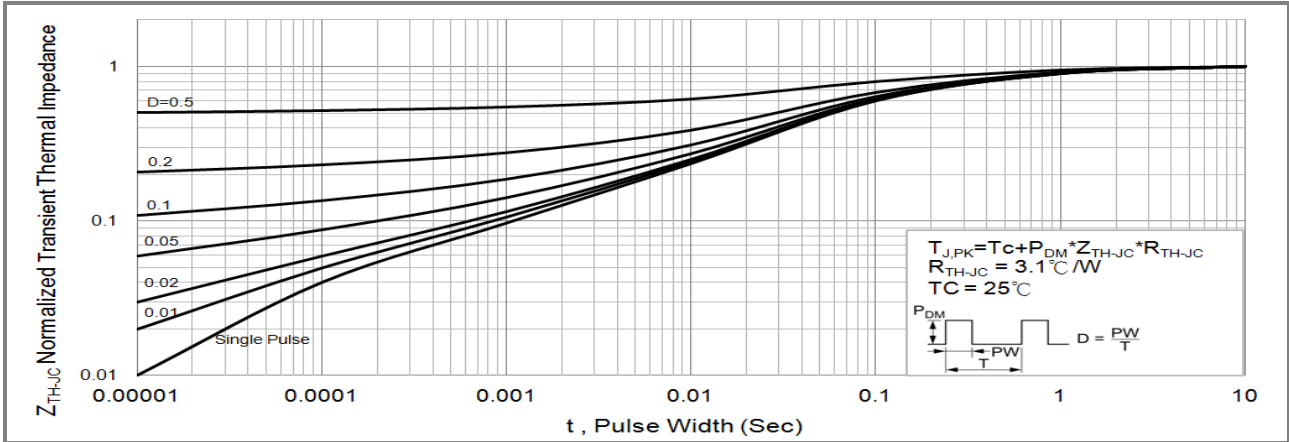

Fig.12 Normalized Transient Thermal Impedance vs. Pulse Width



PJQ5468A

PART NO PACKING CODE VERSION

Part No Packing Code	Package Type	Packing type	Marking	Version
PJQ5468A_R2_00001	DFN5060-8L	3000pcs / 13" reel	Q5468A	Halogen free

Packaging Information & Mounting Pad Layout

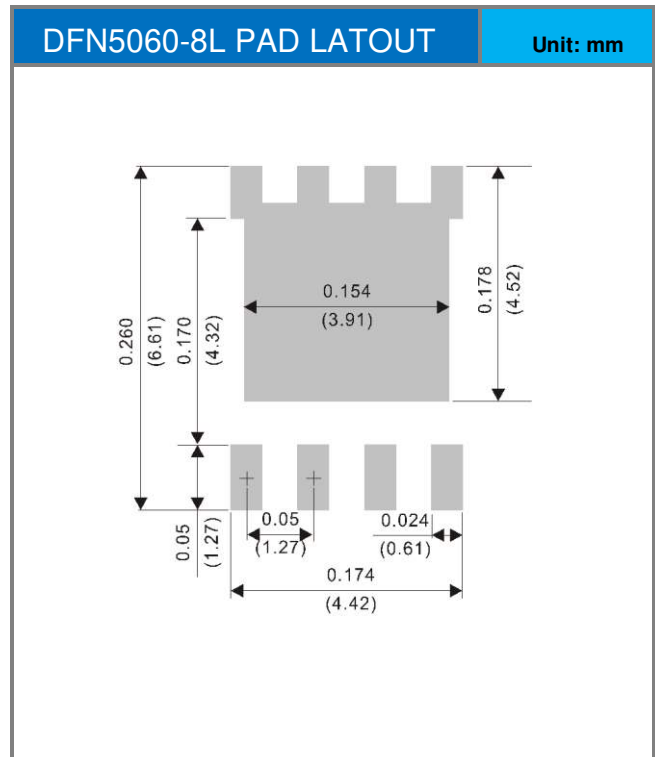
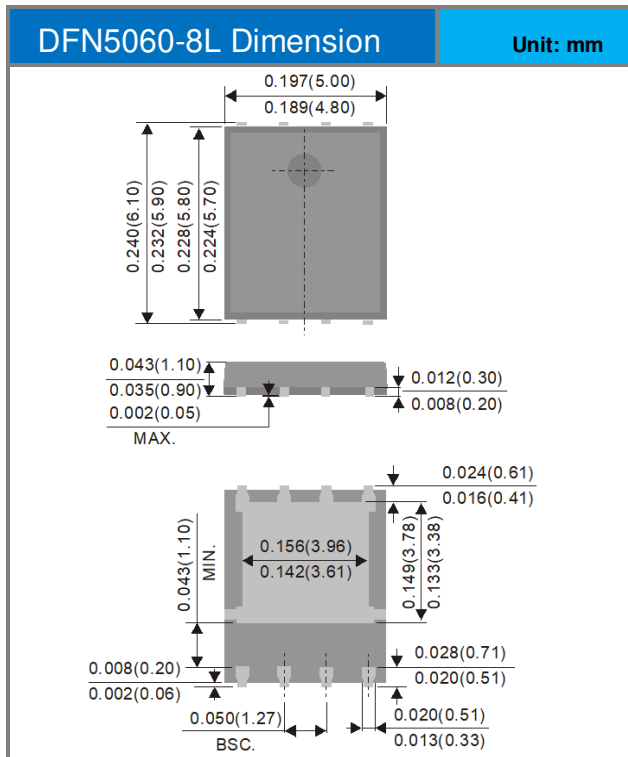



PJQ5468A

Disclaimer

- Reproducing and modifying information of the document is prohibited without permission from Panjit International Inc..
- Panjit International Inc. reserves the rights to make changes of the content herein the document anytime without notification. Please refer to our website for the latest document.
- Panjit International Inc. disclaims any and all liability arising out of the application or use of any product including damages incidentally and consequentially occurred.
- Panjit International Inc. does not assume any and all implied warranties, including warranties of fitness for particular purpose, non-infringement and merchantability.
- Applications shown on the herein document are examples of standard use and operation. Customers are responsible in comprehending the suitable use in particular applications. Panjit International Inc. makes no representation or warranty that such applications will be suitable for the specified use without further testing or modification.
- The products shown herein are not designed and authorized for equipments requiring high level of reliability or relating to human life and for any applications concerning life-saving or life-sustaining, such as medical instruments, transportation equipment, aerospace machinery et cetera. Customers using or selling these products for use in such applications do so at their own risk and agree to fully indemnify Panjit International Inc. for any damages resulting from such improper use or sale.
- Since Panjit uses lot number as the tracking base, please provide the lot number for tracking when complaining.