

KS/KWS/KWD SERIES

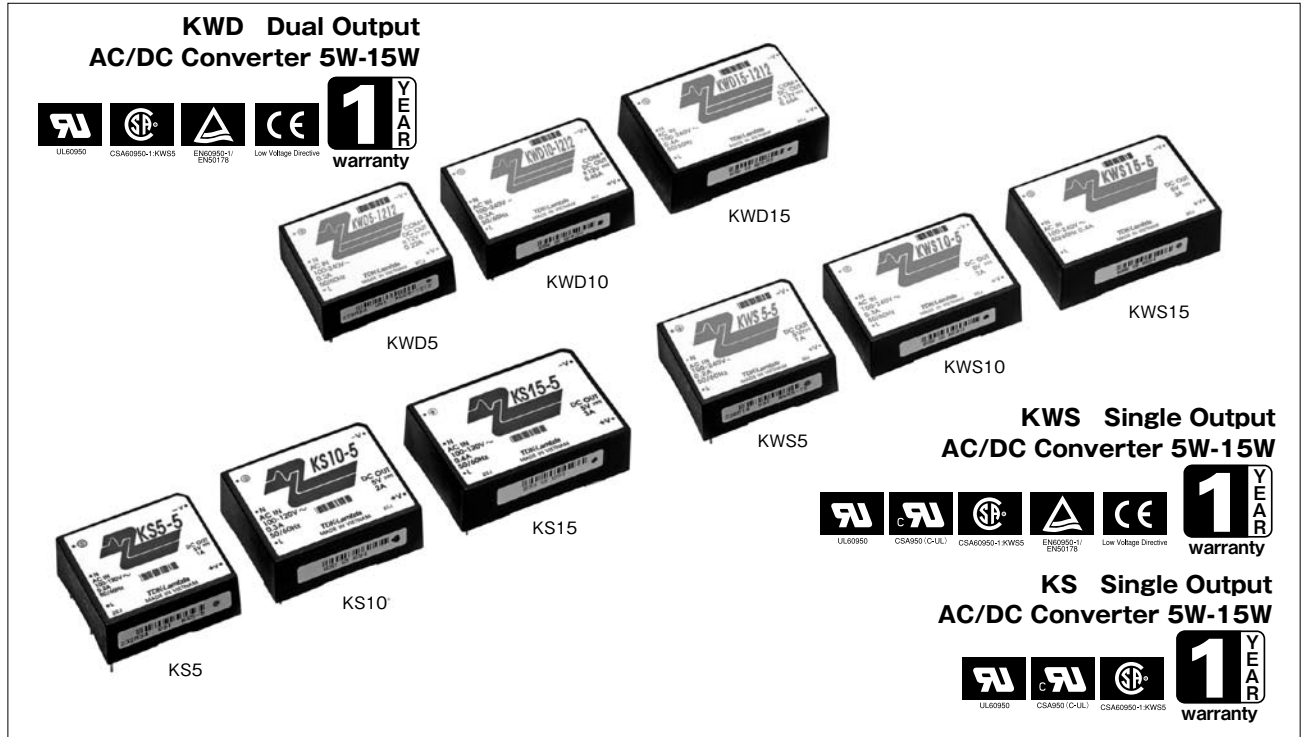

■ Features

- On board type AC/DC converter, making full use of SMT technology, and reduction in size and weight is pursued.
- Functions of over current protection (OCP) and over voltage protection (OVP) equipped.
- AC100Vin and single-output type (KS series)
- Worldwide-applicable input and single output (KWS series)
- Worldwide-applicable input and dual output (KWD series)
- Internal capacitor: Aluminum electrolytic (input smoothing), organic semiconductor electrolytic (output smoothing), ceramic

■ Model naming method

KS 5 - 5

Output voltage 5VDC, 12VDC
 Output power 5W, 10W, 15W
 Series name KS, KWS, KWD

■ Applications

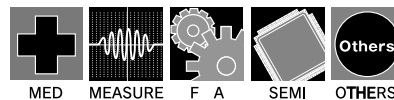

■ Conformity to RoHS Directive

This means that, in conformity with EU Directive 2002/95/EC, lead, cadmium, mercury, hexavalent chromium, and specific bromine-based flame retardants, PBB and PBDE, have not been used, except for exempted applications.

■ Product Line up

KS (Single output, AC100Vin)

Output Voltage	5W		10W		15W	
	Output Current	Model	Output Current	Model	Output Current	Model
5V	1.0A	KS5-5	2.0A	KS10-5	3.0A	KS15-5
12V	0.45A	KS5-12	0.9A	KS10-12	1.3A	KS15-12

KWS (Single output, AC100/200Vin)

Output Voltage	5W		10W		15W	
	Output Current	Model	Output Current	Model	Output Current	Model
5V	1.0A	KWS5-5	2.0A	KWS10-5	3.0A	KWS15-5
12V	0.45A	KWS5-12	0.9A	KWS10-12	1.3A	KWS15-12
15V	0.35A	KWS5-15	0.7A	KWS10-15	1A	KWS15-15

KWD (Dual output, AC100/200Vin)

Output Voltage	5W		10W		15W	
	Output Current	Model	Output Current	Model	Output Current	Model
±12V	0.22A	KWD5-1212	0.45A	KWD10-1212	0.65A	KWD15-1212
±15V	0.18A	KWD5-1515	0.36A	KWD10-1515	0.52A	KWD15-1515

KS5 Specifications

ITEMS/UNITS		MODEL	KS5-5	KS5-12
Input	Voltage Range	(*2) V	AC85 - 132 or DC110 - 175	
	Frequency	(*2) Hz	47 - 440Hz	
	Efficiency (typ)	(*1) %	67	69
	Current (100VAC)(typ)	(*1) A	0.2	
	Inrush Current (100VAC)(typ)	A	15 at Ta = 25°C	
Output	Nominal Voltage	VDC	5	12
	Minimum Current	A	0	
	Maximum Current	A	1.0	0.45
	Maximum Power	W	5.0	5.4
	Voltage Setting Accuracy		Fixed ±5% (Max)	
	Maximum Line Regulation(*3)(*4)	mV	20	48
	Maximum Load Regulation(*3)(*5)	mV	40	96
	Temperature Coefficient(*3)(*6)		50	120
	Maximum Ripple & Noise (*3)	mVp-p	120	150
	Hold-up Time (100VAC)(typ)	ms	17 at 5W, Ta = 25°C	
Function	Over Current Protection (*7)		>105%	
	Over Voltage Protection (*8)		>110%	
	Parallel Operation		No	
	Series Operation		Yes	
Environment	Operating Temperature	°C	-10 to 70 (-10 : 80%, 0 to 50 : 100%, 70 : 25%)	
	Storage Temperature	°C	-30 to 85	
	Operating Humidity	%RH	30 - 90 (No dewdrop)	
	Storage Humidity	%RH	20 - 95 (No dewdrop)	
	Vibration		10 - 55Hz, constant amplitude 1.65mmp-p (Max98.1m/s ²), sweep 1 minute X, Y, Z 1 hour each	
	Shock		Less than 490.3m/s ² for 11±5ms on ±(X, Y, Z) axis each 3 times	
	Cooling		Convection cooling	
Isolation	Withstand Voltage		Input - Output : 2kVAC(20mA), Input - FG : 2kVAC(20mA) Output - FG : 500VAC(100mA) for 1 minute each	
	Isolation Resistance		More than 100MΩ at 25°C and 70%RH, Output - FG 500VDC	
Standards	Safety Standards		Approved by UL60950 - 1 & CSA C22.2 No.60950-1, Built to meet DENAN	
	EMI		Built to meet VCCI - Class A & FCC class B	
Mechanical	Weight	g	70	
	Size (W x H x D)	mm	43 x 19.5 x 48	

KS
KWS
KWD

- (*1) At 100VAC and maximum output power, Ta = 25°C.
- (*2) For cases where conformance to various safety specs (UL, CSA) are required, to be described as 100 - 120VAC, 50/60Hz on name plate.
- (*3) Please refer to Fig. A for measurement determination of line & load regulation and output ripple & noise voltage.
- (*4) From 85 - 132VAC, constant load.
- (*5) From min load - full load (maximum power), constant input voltage.
- (*6) From 0 to 50°C, constant input voltage and load.
- (*7) Current limiting with automatic recovery. Avoid to operate over load or dead short for more than 30 seconds.
- (*8) Over voltage clamping by zener diode.

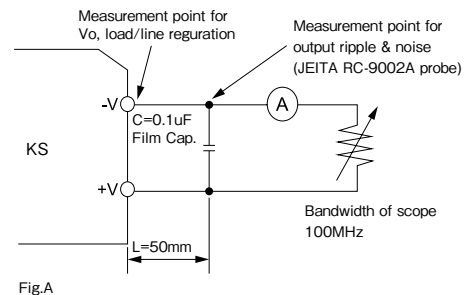

Output Derating

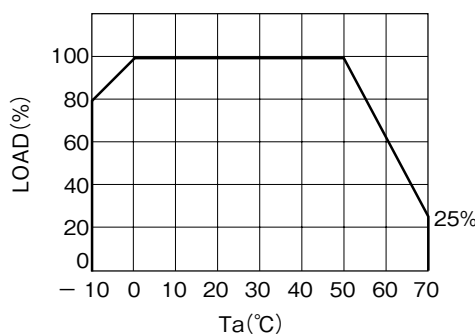

KS10 Specifications

ITEMS/UNITS		MODEL	KS10-5	KS10-12
Input	Voltage Range	(*2) V	AC85 - 132 or DC110 - 175	
	Frequency	(*2) Hz	47 - 440Hz	
	Efficiency (typ)	(*1) %	73	74
	Current (100VAC)(typ)	(*1) A	0.3	
	Inrush Current (100VAC)(typ)	A	10 at Ta = 25°C, cold start	
Output	Nominal Voltage	VDC	5	12
	Minimum Current	A	0	
	Maximum Current	A	2.0	0.9
	Maximum Power	W	10.0	10.8
	Voltage Setting Accuracy	%	Fixed ±5% (Max)	
	Maximum Line Regulation(*3)(*4)	mV	20	48
	Maximum Load Regulation (*3)(*5)	mV	40	96
	Temperature Coefficient(*3)(*6)		50	120
	Maximum Ripple & Noise (*3)	mVp-p	120	150
	Hold-up Time (100VAC)(typ)	ms	17 at 10W, Ta = 25°C	
Function	Over Current Protection (*7)		>105%	
	Over Voltage Protection (*8)		>110%	
	Parallel Operation		No	
	Series Operation		Yes	
Environment	Operating Temperature	°C	-10 to 70 (-10 : 80%, 0 to 50 : 100%, 70 : 25%)	
	Storage Temperature	°C	-30 to 85	
	Operating Humidity	%RH	30 - 90 (No dewdrop)	
	Storage Humidity	%RH	20 - 95 (No dewdrop)	
	Vibration		10 - 55Hz, constant amplitude 1.65mmp-p (max 98.1m/s ²), sweep 1 minute X, Y, Z 1 hour each	
	Shock		Less than 490.3m/s ² for 11±5mS on ±(X, Y, Z) axis each 3 times	
	Cooling		Convection cooling	
Isolation	Withstand Voltage		Input - Output : 2kVAC (20mA), Input - FG : 2kVAC (20mA) Output - FG : 500VAC (100mA) for 1 minute each	
	Isolation Resistance		More than 100MΩ at 25°C and 70%RH Output - FG 500VDC	
Standards	Safety Standards		Approved by UL60950 - 1 & CSA C22.2 No.60950-1, Built to meet DENAN	
	EMI		Built to meet VCCI - Class A & FCC class B	
Mechanical	Weight	g	85	
	Size (W x H x D)	mm	45 x 20.5 x 55	

KS
KWS
KWD

- (*1) At 100VAC and maximum output power, Ta = 25°C.
- (*2) For cases where conformance to various safety specs (UL, CSA) are required, to be described as 100 - 120VAC, 50/60Hz on name plate.
- (*3) Please refer to Fig. A for measurement determination of line & load regulation and output ripple & noise voltage.
- (*4) From 85 - 132VAC, constant load.
- (*5) From min load - full load (maximum power), constant input voltage.
- (*6) From 0 to +50°C, constant input voltage and load.
- (*7) Current limiting with automatic recovery. Avoid to operate over load or dead short for more than 30 seconds.
- (*8) Over voltage clamping by zener diode.

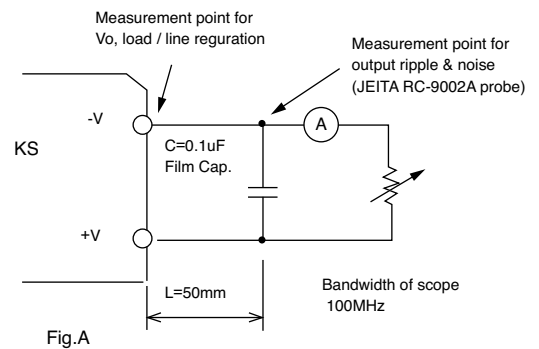

Output Derating

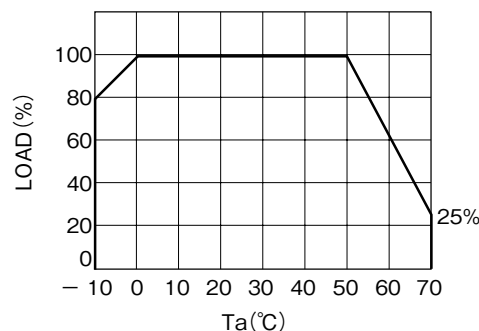

KS15 Specifications

ITEMS/UNITS		MODEL	KS15-5	KS15-12
Input	Voltage Range (*2)	V	AC85 - 132 or DC110 - 175	
	Frequency (*2)	Hz	47 - 440	
	Efficiency (typ)	(%)*1	74	76
	Current (100VAC)(typ)	(A)*1	0.4	
	Inrush Current (100VAC)(typ)	A	10 at Ta = 25°C, cold start	
Output	Nominal Voltage	VDC	5	12
	Minimum Current	A	0	
	Maximum Current	A	3.0	1.3
	Maximum Power	W	15.0	15.6
	Voltage Setting Accuracy	%	Fixed ± 5% (Max)	
	Maximum Line Regulation(*3)(*4)	mV	20	48
	Maximum Load Regulation(*3)(*5)	mV	40	96
	Temperature Coefficient(*3)(*6)	mV	50	120
	Maximum Ripple & Noise (*3)	mVp-p	120	150
	Hold-up Time (100VAC)(typ)	ms	17 at 15W, Ta = 25°C	
Function	Over Current Protection (*7)		>105%	
	Over Voltage Protection (*8)		>110%	
	Parallel Operation		No	
	Series Operation		Yes	
Environment	Operating Temperature (*9)	°C	-10 to 70 (-10 : 80%, 0 to 50 : 100%, 70 : 25%)	
	Storage Temperature	°C	-30 to 85	
	Operating Humidity	%RH	30 - 90 (No dewdrop)	
	Storage Humidity	%RH	20 - 95 (No dewdrop)	
	Vibration (*10)		10 - 55Hz, constant amplitude 1.65mmp-p (Max 98.1m/s ²), sweep 1 minute X, Y, Z 1 hour each	
	Shock		Less than 490.3m/s ² for 11±5mS on ±(X, Y, Z) axis each 3 times	
Isolation	Withstand Voltage		Input - Output : 2kVAC (20mA), Input - FG : 2kVAC (20mA) Output - FG : 500VAC (100mA) for 1minute each	
	Isolation Resistance		More than 100MΩ at 25°C and 70%RH Output - FG 500VDC	
	Safety Standards		Approved by UL60950 - 1 & CSA C22.2 No.60950-1, Built to meet DENAN	
Standards	EMI		Built to meet VCCI-Class A & FCC class B	
	Weight	g	100	
Mechanical	Size (W x H x D)	mm	45 x 20.5 x 64	

KS
KWS
KWD

- (*1) At 100VAC and maximum output power, Ta = 25°C.
- (*2) For cases where conformance to various safety specs (UL, CSA) are required to be described as 100 - 120VAC, 50/60Hz on name plate.
- (*3) Please refer to Fig. A for measurement determination of line & load regulation and output ripple & noise voltage.
- (*4) From 85 - 132VAC or 110 - 175VDC, constant load.
- (*5) From min load - full load (maximum power), constant input voltage.
- (*6) From 0 to +50°C, constant input voltage and load.
- (*7) Current limiting with automatic recovery. Avoid to operate over load or dead short for more than 30 seconds.
- (*8) Over voltage clamping by zener diode.

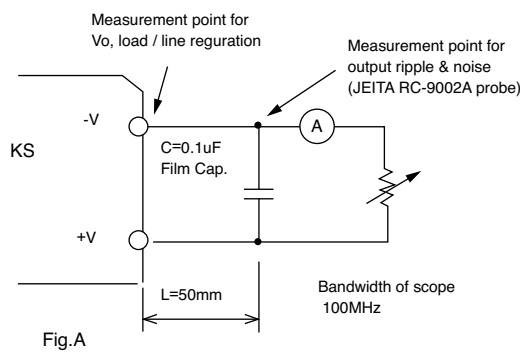

Output Derating

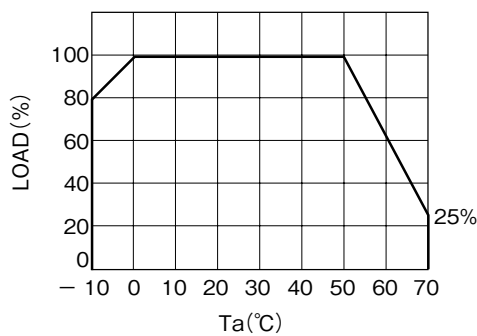

Outline Drawing

[KS5]

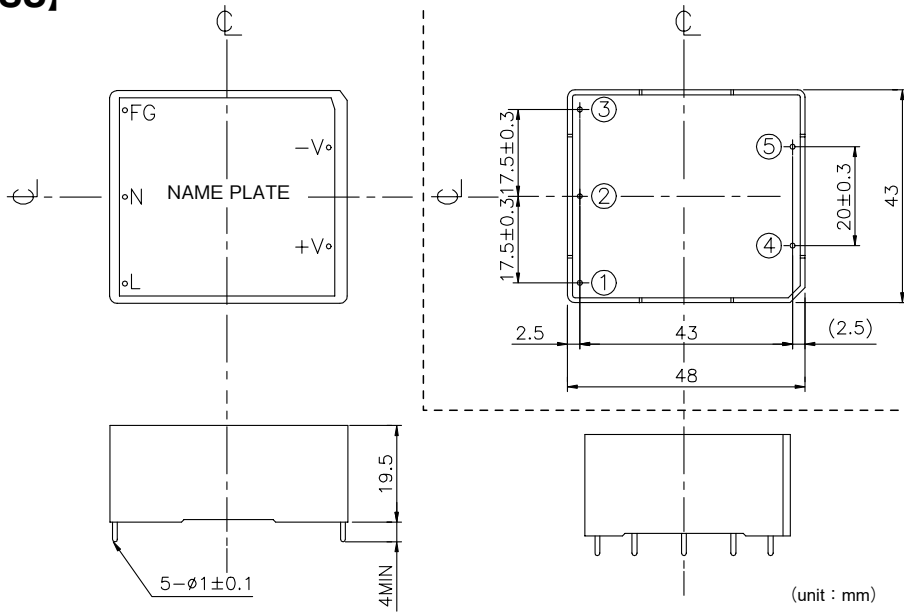

*TERMINAL ASSIGNMENTS

- ①...FG
- ②...AC (N)] INPUT
- ③...AC (L)]
- ④...-V] OUTPUT
- ⑤...+V]

*MATERIAL

CASE : PLASTIC (UL94V-0)

(unit : mm)

KS
KWS
KWD

[KS10]

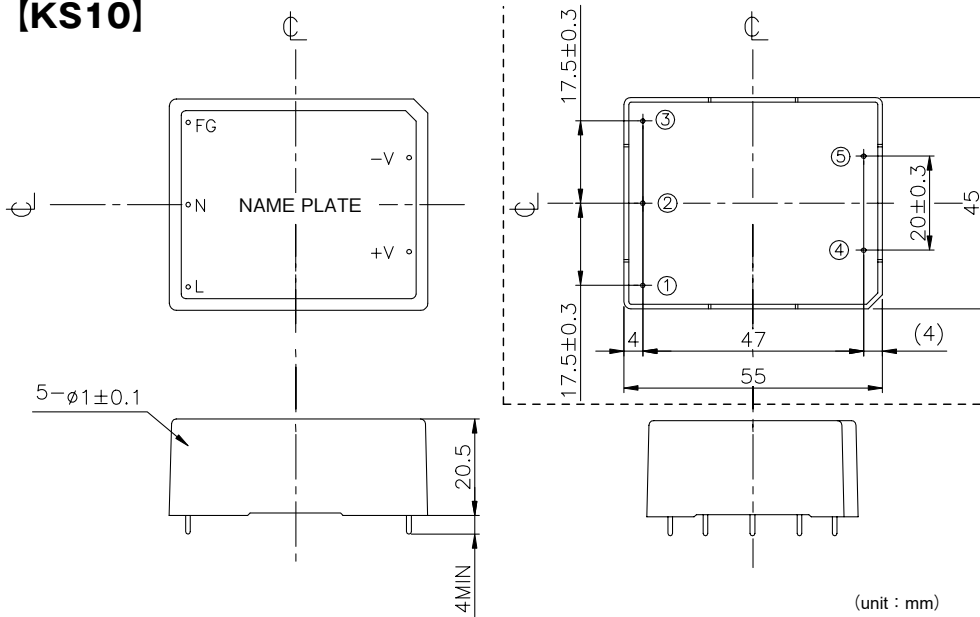

*TERMINAL ASSIGNMENTS

- ①...FG
- ②...AC (N)] INPUT
- ③...AC (L)]
- ④...-V] OUTPUT
- ⑤...+V]

*MATERIAL

CASE : PLASTIC (UL94V-0)

(unit : mm)

[KS15]

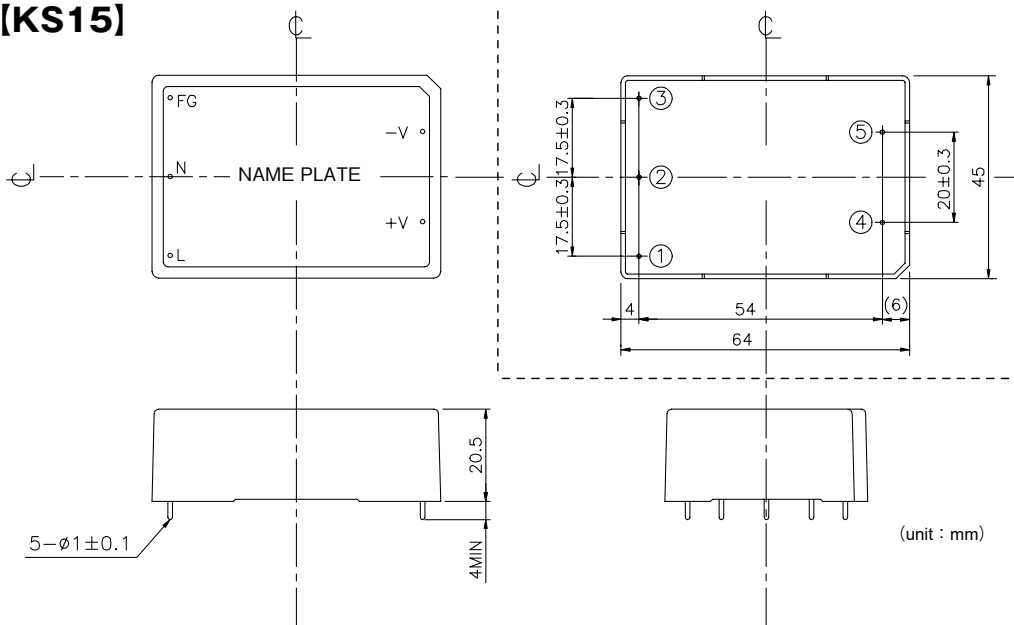

*TERMINAL ASSIGNMENTS

- ①...FG
- ②...AC (N)] INPUT
- ③...AC (L)]
- ④...-V] OUTPUT
- ⑤...+V]

*MATERIAL

CASE : PLASTIC (UL94V-0)

(unit : mm)

KWS5 Specifications

ITEMS/UNITS		MODEL	KWS5-5	KWS5-12	KWS5-15
Input	Voltage Range	(*2) V	AC85 - 265 or DC110 - 340		
	Frequency	(*2) Hz	47 - 440		
	Efficiency (typ)	(*1) %	67	70	
	Current (100VAC)(typ)	(*1) A	0.2		
	Inrush Current (100/200VAC)(typ)	A	15 / 30		
Output	Nominal Voltage	VDC	5	12	15
	Minimum Current	A	0		
	Maximum Current	A	1.0	0.45	0.35
	Maximum Power	W	5.0	5.4	5.25
	Voltage Setting Accuracy	%	Fixed ±5% (Max)		
	Maximum Line Regulation(*3)(*4)	mV	20	48	60
	Maximum Load Regulation(*3)(*5)	mV	40	96	120
	Temperature Coefficient (*3)(*6)	mV	50	120	150
	Maximum Ripple & Noise (*3)	mVp-p	120	150	
	Hold-up Time (100VAC)(typ)	ms	17 at 5W, Ta=25°C		
Function	Over Current Protection (*7)		>105%		
	Over Voltage Protection (*8)		>110%		
	Parallel Operation		No		
	Series Operation		Possible		
Environment	Operating Temperature	°C	-10 to 70 (-10 : 80%, 0 to 50 : 100%, 70 : 25%)		
	Storage Temperature	°C	-30 to 85		
	Operating Humidity	%RH	30 - 90 (No dewdrop)		
	Storage Humidity	%RH	20 - 95 (No dewdrop)		
	Vibration		10 - 55Hz, constant amplitude 1.65mmp-p (Max 98.1m/s ²), sweep 1 minute X, Y, Z 1 hour each		
	Shock		Less than 490.3m/s ² for 11 ± 5ms on ± (X, Y, Z) axis each 3 times		
	Cooling		Convection cooling		
Isolation	Withstand Voltage		Input-Output : 3kVAC (20mA), Input-FG : 2kVAC (20mA) Output-FG : 500VAC (100mA) for 1 minute each		
	Isolation Resistance		More than 100MΩ at 25°C and 70% RH Output-FG 500VDC		
Standards	Safety Standards		Approved by UL60950-1, CSA C22.2 No.60950-1 & EN60950		
	EMI	(*9)	Built to meet VCCI-Class A & FCC class B & VDE class B		
Mechanical	Weight	g	75		
	Size (W x H x D)	mm	45 x 20.5 x 55		

KS
KWS
KWD

- (*1) At 100VAC and maximum output power, Ta=25°C.
- (*2) For cases where conformance to various safety specs (UL, CSA, TUV) are required, to be described as 100 - 240VAC, 50/60Hz on name plate.
- (*3) Please refer to Fig. A for measurement determination of line & load regulation and output ripple & noise voltage.
- (*4) From 85 - 265VAC, constant load.
- (*5) From min load - full load (maximum power), constant input voltage.
- (*6) From 0 to 50°C, constant input voltage and load.
- (*7) Current limiting with automatic recovery. Avoid to operate over load or dead short for more than 30 seconds.
- (*8) Over voltage clamping by zener diode.
- (*9) VDE class-B with external capacitor.

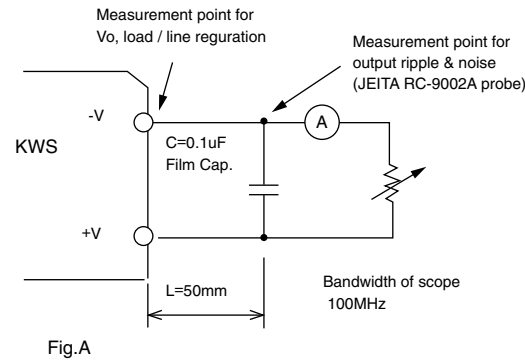

Output Derating

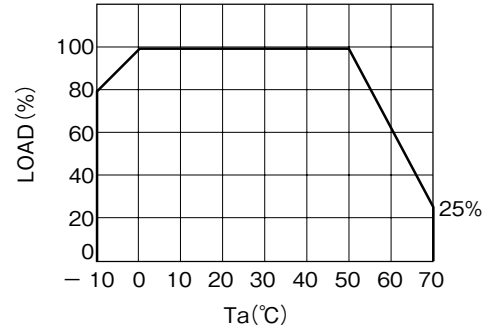

KWS10 Specifications

ITEMS/UNITS		MODEL	KWS10-5	KWS10-12	KWS10-15
Input	Voltage Range	(*2) V	AC85 - 265 or DC110 - 340		
	Frequency	(*2) Hz	47 - 440		
	Efficiency (typ)	(*1) %	73	75	
	Current (100VAC)(typ)	(*1) A	0.3		
	Inrush Current (100/200VAC)(typ)	A	15 / 30		
Output	Nominal Voltage	VDC	5	12	15
	Minimum Current	A	0		
	Maximum Current	A	2.0	0.9	0.7
	Maximum Power	W	10.0	10.8	10.5
	Voltage Setting Accuracy	%	Fixed $\pm 5\%$ (Max)		
	Maximum Line Regulation(*3)(*4)	mV	20	48	60
	Maximum Load Regulation (*3)(*5)	mV	40	96	120
	Temperature Coefficient(*3)(*6)	mV	50	120	150
	Maximum Ripple & Noise (*3)	mVp-p	120	150	
Function	Hold-up Time (100VAC)(typ)	ms	17 at 10W, Ta=25°C		
	Over Current Protection (*7)		>105%		
	Over Voltage Protection (*8)		>110%		
	Parallel Operation		No		
Environment	Series Operation		Possible		
	Operating Temperature	°C	-10 to 70 (-10 : 80%, 0 to 50 : 100%, 70 : 25%)		
	Storage Temperature	°C	-30 to 85		
Mechanical	Operating Humidity	%RH	30 - 90 (No dewdrop)		
	Storage Humidity	%RH	20 - 95 (No dewdrop)		
	Vibration		10 - 55Hz, constant amplitude 1.65mmp-p (Max 98.1m/s ²), sweep 1 minute X, Y, Z 1 hour each		
	Shock		Less than 490.3m/s ² for 11±5ms on \pm (X, Y, Z) axis each 3 times		
	Cooling		Convection cooling		
Isolation	Withstand Voltage		Input-Output : 3kVAC (20mA), Input-FG : 2kVAC (20mA) Output-FG : 500VAC (100mA) for 1 minute each		
	Isolation Resistance		More than 100M Ω at 25°C and 70% RH Output-FG 500VDC		
Standards	Safety Standards		Approved by UL60950-1, CSA C22.2 No.60950-1 & EN60950		
	EMI	(*9)	Built to meet VCCI-Class A & FCC class B & VDE class B		
Mechanical	Weight	g	100		
	Size (W x H x D)	mm	45 x 20.5 x 64		

KS
KWS
KWD

- (*1) At 100VAC and maximum output power, Ta=25°C.
- (*2) For cases where conformance to various safety specs (UL, CSA, TUV) are required, to be described as 100 - 240VAC, 50/60Hz on name plate.
- (*3) Please refer to Fig. A for measurement determination of line & load regulation and output ripple & noise voltage.
- (*4) From 85 - 265VAC, constant load.
- (*5) From min load - full load (maximum power), constant Input voltage.
- (*6) From 0 to +50°C, constant input voltage and load.
- (*7) Current limiting with automatic recovery. Avoid to operate over load or dead short for more than 30 seconds.
- (*8) Over voltage clamping by zener diode.
- (*9) VDE class-B with external capacitor.

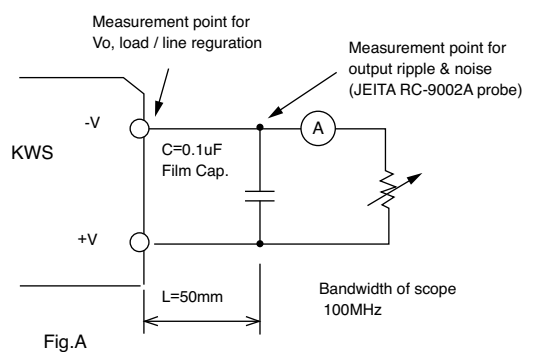

Output Derating

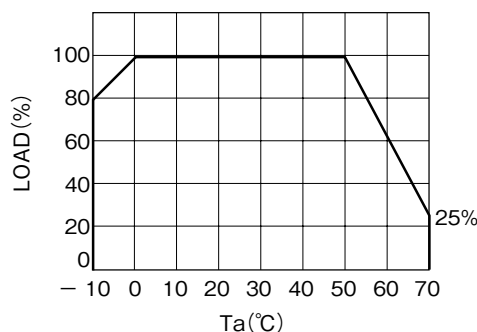

KWS15 Specifications

ITEMS/UNITS		MODEL	KWS15-5	KWS15-12	KWS15-15
Input	Voltage Range (*2)	V	AC85 - 265 or DC110 - 340		
	Frequency (*2)	Hz	47 - 440		
	Efficiency (typ) (*1)	%	74	77	
	Current (100VAC)(typ) (*1)	A	0.4		
	Inrush Current (100/200VAC)(typ)	A	20 / 40		
Output	Nominal Voltage	VDC	5	12	15
	Minimum Current	A	0		
	Maximum Current	A	3	1.3	1.0
	Maximum Power	W	15.0	15.6	15
	Voltage Setting Accuracy	%	Fixed ±5% (Max)		
	Maximum Line Regulation(*3)(*4)	mV	20	48	60
	Maximum Load Regulation(*3)(*5)	mV	40	96	120
	Temperature Coefficient (*3)(*6)	mV	50	120	150
	Maximum Ripple & Noise (*3)	mVp-p	120	150	
	Hold-up Time (100VAC)(typ)	ms	17 at 15W, Ta=25°C		
Function	Over Current Protection (*7)		>105%		
	Over Voltage Protection (*8)		>110%		
	Parallel Operation		No		
	Series Operation		Possible		
Environment	Operating Temperature	°C	-10 to 70 (-10 : 80%, 0 to 50 : 100%, 70 : 25%)		
	Storage Temperature	°C	-30 to 85		
	Operating Humidity	%RH	30 - 90 (No dewdrop)		
	Storage Humidity	%RH	20 - 95 (No dewdrop)		
	Vibration		10 - 55Hz, constant amplitude 1.65mmp-p (Max 98.1m/s ²), sweep 1 minute X, Y, Z 1 hour each		
	Shock		Less than 490.3m/s ² for 11±5ms on ± (X, Y, Z) axis each 3 times		
	Cooling		Convection cooling		
Isolation	Withstand Voltage		Input-Output : 3kVAC (20mA), Input-FG : 2kVAC (20mA) Output-FG : 500VAC (100mA) 1 min		
	Isolation Resistance		More than 100MΩ at 25°C and 70% RH Output-FG 500VDC		
Standards	Safety Standards		Approved by UL60950-1, CSA C22.2 No.60950-1, EN60950		
	EMI (*9)		Built to meet VCCI-Class A & FCC class B & VDE class B		
Mechanical	Weight	g	150		
	Size (W x H x D)	mm	48 x 23.5 x 70		

KS
KWS
KWD

(*1) At 100VAC and maximum output power, Ta=25°C.

(*2) For cases where conformance to various safety specs (UL, CSA, TUV) are required, to be described as 100 - 240VAC, 50/60Hz on name plate.

(*3) Please refer to Fig. A for measurement determination of line & load regulation and output ripple & noise voltage.

(*4) From 85 - 265VAC, constant load.

(*5) From min load - full load (maximum power), constant input voltage.

(*6) From 0 to 50°C, constant input voltage and load.

(*7) Current limiting with automatic recovery. Avoid to operate over load or dead short for more than 30 seconds.

(*8) Over voltage clamping by zener diode.

(*9) VDE class-B with external capacitor.

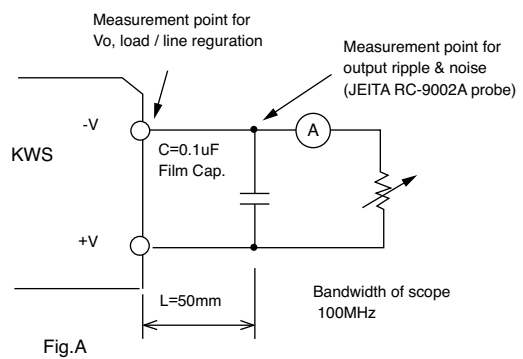

Output Derating

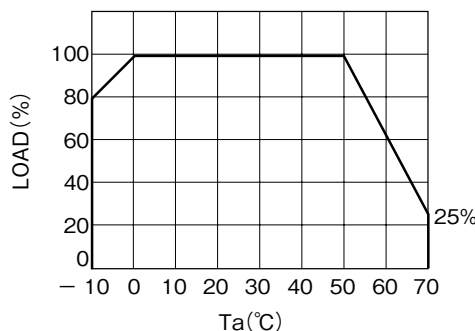

Outline Drawing

[KWS5]

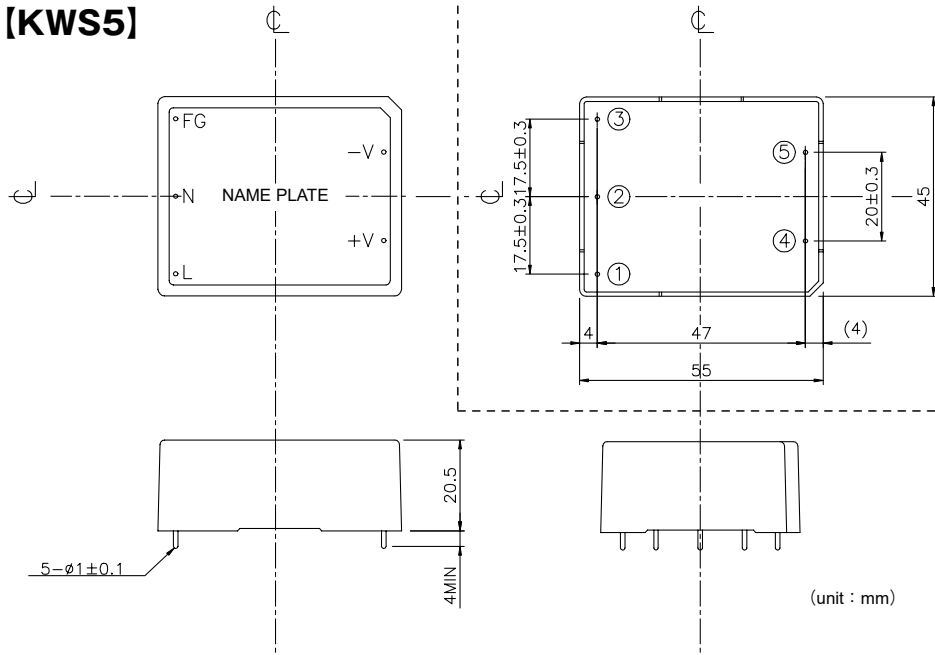

*TERMINAL ASSIGNMENTS

- ①...FG
- ②...AC(N)
- ③...AC(L)] INPUT
- ④...-V
- ⑤...+V] OUTPUT

*MATERIAL

CASE : PLASTIC (UL94V-0)

KS
KWS
KWD

[KWS10]

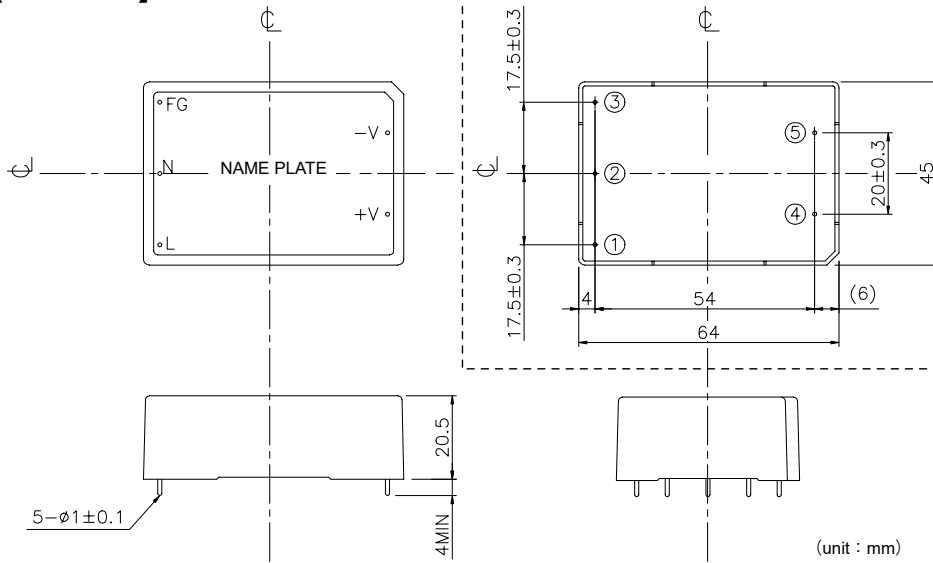

*TERMINAL ASSIGNMENTS

- ①...FG
- ②...AC(N)
- ③...AC(L)] INPUT
- ④...-V
- ⑤...+V] OUTPUT

*MATERIAL

CASE : PLASTIC (UL94V-0)

[KWS15]

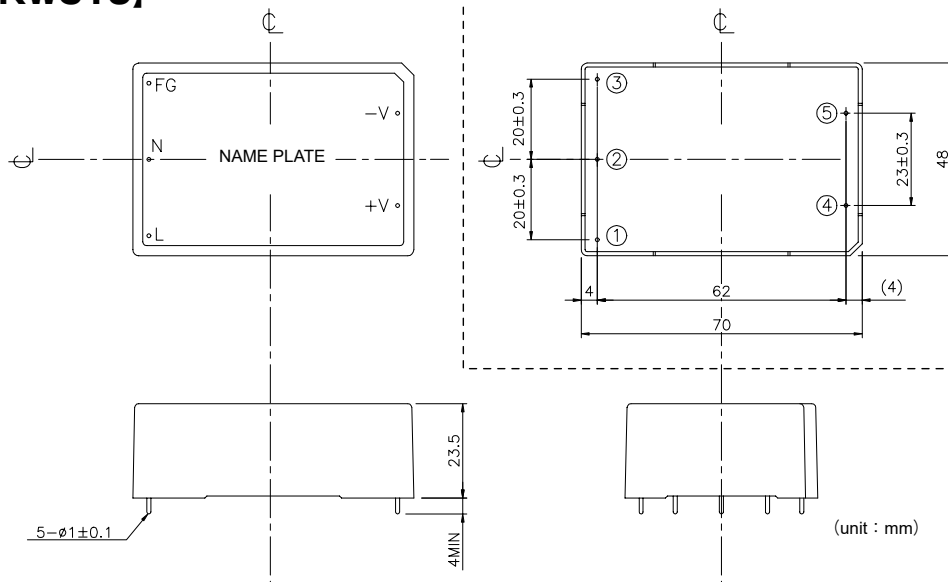

*TERMINAL ASSIGNMENTS

- ①...FG
- ②...AC(N)
- ③...AC(L)] INPUT
- ④...-V
- ⑤...+V] OUTPUT

*MATERIAL

CASE : PLASTIC (UL94V-0)

KWD5 Specifications

ITEMS/UNITS		MODEL	KWD5-1212		KWD5-1515	
		CH	1	2	1	2
Input	Voltage Range	(*2) V	AC85 - 265 or DC110 - 340			
	Frequency	(*2) Hz	47 - 440			
	Efficiency (typ)	(*1) %	69		69	
	Current (100VAC)(typ)	(*1) A	0.2			
	Inrush Current (100/200VAC)(typ)	A	15 / 30 at Ta = 25°C			
Output	Nominal Voltage	VDC	+12	-12	+15	-15
	Minimum Current	A	0	0	0	0
	Maximum Current	A	0.22	0.22	0.18	0.18
	Maximum Power	W	5.3		5.4	
	Voltage Setting Accuracy	%	Fixed ±5% (Max)		Fixed ±5% (Max)	
	Maximum Line Regulation(*3)(*4)	mV	60	60	75	75
	Maximum Load Regulation(*3)(*5)	mV	600	600	750	750
	Temperature Coefficient(*3)(*6)	mV	120	120	150	150
	Maximum Ripple & Noise (*3)	mVp-p	150	150	150	150
	Hold-up Time (100VAC)(typ)	ms	17 at 5W, Ta = 25°C			
Function	Over Current Protection (*7)		>105%			
	Over Voltage Protection (*8)		>110%			
	Parallel Operation		-----			
	Series Operation		Possible			
Environment	Operating Temperature (*9)	°C	-10 to 70 (-10 : 80%, 0 to 50 : 100%, 70 : 25%)			
	Storage Temperature	°C	-30 to 85			
	Operating Humidity	%RH	30 - 90 (No dewdrop)			
	Storage Humidity	%RH	20 - 95 (No dewdrop)			
	Vibration		10 - 55Hz, constant amplitude 1.65mmp-p (Max 98.1m/s ²), sweep 1 minute X, Y, Z 1 hour each			
Isolation	Shock		Less than 490.3m/s ² for 11±5mS on ±(X, Y, Z) axis each 3 times			
	Cooling		Convection cooling			
	Withstand Voltage		Input - Output : 3kVAC (20mA), Input - FG : 2kVAC (20mA), Output - FG : 500VAC (100mA) 1 min			
Standards	Isolation Resistance		More than 100MΩ at 25°C and 70%RH Output - FG 500VDC			
	Safety Standards		Approved by UL60950 - 1, CSA C22.2 No.60950-1 & EN60950			
Mechanical	EMI	(*9)	Built to meet VCCI - Class B, FCC class B, VDE class B			
	Weight	g	75			
	Size (W x H x D)	mm	45 x 20.5 x 55			

KS
KWS
KWD

- (*1) At 100VAC and maximum output power, Ta = 25°C.
- (*2) For cases where conformance to various safety specs (UL, CSA, TUV) are required, to be described as 100 - 240VAC, 50/60Hz on name plate.
- (*3) Please refer to Fig. A for measurement determination of line & load regulation and output ripple & noise voltage.
- (*4) From 85 - 265VAC constant load.
- (*5) From min load - full load (maximum power), constant input voltage.
- (*6) From 0 to 50°C, constant input voltage and load.
- (*7) Current limiting with automatic recovery. Avoid to operate over load or dead short for more than 30 seconds.
- (*8) Over voltage clamping by zener diode (on CH2 only).
- (*9) VDE class B with external capacitor.

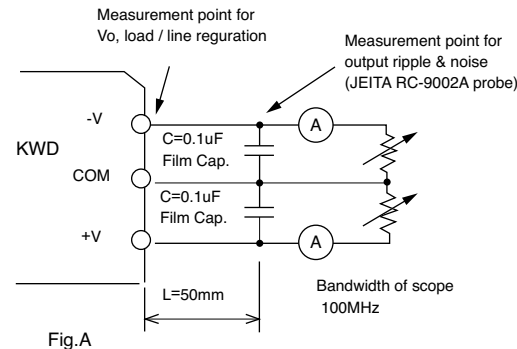

Output Derating

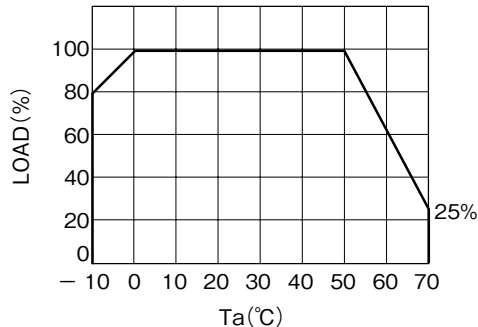

KWD10 Specifications

ITEMS/UNITS		MODEL	KWD10-1212		KWD10-1515	
			1	2	1	2
Input	Voltage Range	(*2) V	AC85 - 265 or DC110 - 340			
	Frequency	(*2) Hz	47 - 440			
	Efficiency (typ)	(*1) %	72			
	Current (100VAC)(typ)	(*1) A	0.3			
	Inrush Current (100/200VAC)(typ)	A	15 / 30 at Ta = 25°C			
Output	Nominal Voltage	VDC	+12	-12	+15	-15
	Minimum Current	A	0	0	0	0
	Maximum Current	A	0.45		0.36	
	Maximum Power	W	10.8		10.8	
	Voltage Setting Accuracy	%	Fixed ±5% (Max)			
	Maximum Line Regulation(*3)(*4)	mV	60	60	75	75
	Maximum Load Regulation (*3)(*5)	mV	600	600	750	750
	Temperature Coefficient(*3)(*6)		120	120	150	150
	Maximum Ripple & Noise (*3)	mVp-p	150	150	150	150
	Hold-up Time (100VAC)(typ)	ms	17 at 5W, Ta = 25°C			
Function	Over Current Protection (*7)		>105%			
	Over Voltage Protection (*8)		>110%			
	Parallel Operation		-----			
	Series Operation		Possible			
Environment	Operating Temperature	°C	-10 to 70 (-10 : 80%, 0 to 50 : 100%, 70 : 25%)			
	Storage Temperature	°C	-30 to 85			
	Operating Humidity	%RH	30 - 90 (No dewdrop)			
	Storage Humidity	%RH	20 - 95 (No dewdrop)			
Mechanical	Vibration		10 - 55Hz, constant amplitude 1.65mmp-p (Max 98.1m/s ²), sweep 1 minute X, Y, Z 1 hour each			
	Shock		Less than 490.3m/s ² for 11±5mS on ±(X, Y, Z) axis each 3 times			
	Cooling		Convection cooling			
Isolation	Withstand Voltage		Input - Output : 3kVAC (20mA), Input - FG : 2kVAC (20mA), Output - FG : 500VAC (100mA) for 1 minute each			
	Isolation Resistance		More than 100MΩ at 25°C and 70%RH Output - FG 500VDC			
Standards	Safety Standards		Approved by UL60950 - 1, CSA C22.2 No.60950-1 & EN60950			
	EMI (*9)		Built to meet VCCI - Class B, FCC class B, VDE class B			
Mechanical	Weight	g	100			
	Size (W x H x D)	mm	45 x 20.5 x 64			

KS
KWS
KWD

- (*1) At 100VAC and maximum output power, Ta = 25°C.
- (*2) For cases where conformance to various safety specs (UL, CSA, TUV) are required, to be described as 100 - 240VAC, 50/60Hz on name plate.
- (*3) Please refer to Fig. A for measurement determination of line & load regulation and output ripple & noise voltage.
- (*4) From 85 - 265VAC, constant load.
- (*5) From min load - full load (maximum power), constant input voltage.
- (*6) From 0 to +50°C, constant input voltage and load.
- (*7) Current limiting with automatic recovery. Avoid to operate over load or dead short for more than 30 seconds.
- (*8) Over voltage clamping by zener diode (on CH2 only).
- (*9) VDE class B with external capacitor.

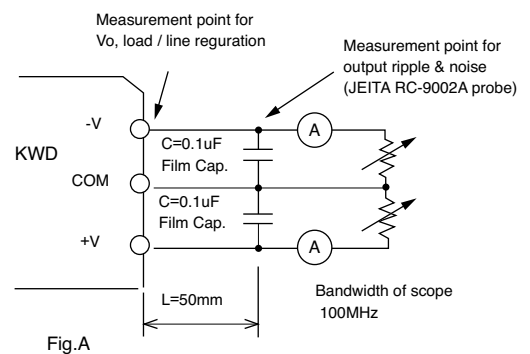

Output Derating

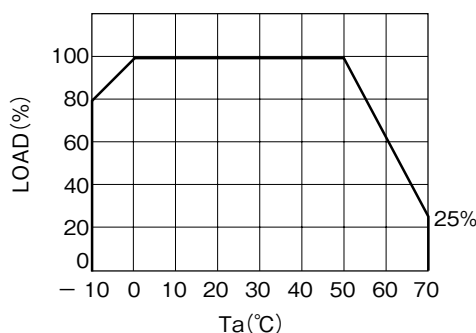

KWD15 Specifications

ITEMS/UNITS	MODEL	KWD15-1212		KWD15-1515	
		1	2	1	2
Input	Voltage Range (*2)	AC85 - 265 or DC110 - 340			
	Frequency (*2)	47 - 440			
	Efficiency (typ) (*1)	75		75	
	Current (100VAC)(typ) (*1)	0.4			
	Inrush Current (100/200VAC)(typ)	20 / 40 at Ta = 25°C			
Output	Nominal Voltage	+12	-12	+15	-15
	Minimum Current	0			
	Maximum Current	0.65		0.52	
	Maximum Power	15.6		15.6	
	Voltage Setting Accuracy	Fixed ±5% (Max)			
	Maximum Line Regulation(*3)(*4)	60	60	75	75
	Maximum Load Regulation(*3)(*5)	600	600	750	750
	Temperature Coefficient(*3)(*6)	120	120	150	150
	Maximum Ripple & Noise (*3)	150	150	150	150
	Hold-up Time (100VAC)(typ)	17 at 5W, Ta = 25°C			
Function	Over Current Protection (*7)	>105%			
	Over Voltage Protection (*8)	>110%			
	Parallel Operation	-----			
	Series Operation	Possible			
Environment	Operating Temperature	-10 to 70 (-10 : 80%, 0 to 50 : 100%, 70 : 25%)			
	Storage Temperature	-30 to 85			
	Operating Humidity	30 - 90 (No dewdrop)			
	Storage Humidity	20 - 95 (No dewdrop)			
	Vibration	10 - 55Hz, constant amplitude 1.65mmp-p (Max 98.1m/s ²), sweep 1 minute X, Y, Z 1 hour each			
	Shock	Less than 490.3m/s ² for 11±5mS on ±(X, Y, Z) axis each 3 times			
Isolation	Withstand Voltage	Input - Output : 3kVAC (20mA), Input - FG : 2kVAC (20mA), Output - FG : 500VAC (100mA) for 1 minute each			
	Isolation Resistance	More than 100MΩ at 25°C and 70%RH Output - FG 500VDC			
	Safety Standards	Approved by UL60950 - 1, CSA C22.2 No.60950-1 & EN60950			
Standards	EMI (*9)	Built to meet VCCI - Class B, ECC Class B, VDE class B			
	Weight	150			
Mechanical	Size (W x H x D)	48 x 23.5 x 70 (Refer to outline drawing)			

KS
KWS
KWD

- (*1) At 100VAC and maximum output power, Ta = 25°C.
- (*2) For cases where conformance to various safety specs (UL, CSA, TUV) are required, to be described as 100 - 240VAC, 50/60Hz on name plate.
- (*3) Please refer to Fig. A for measurement determination of line & load regulation and output ripple & noise voltage.
- (*4) From 85 - 265VAC constant load.
- (*5) From min load - full load (maximum power), constant input voltage.
- (*6) From 0 to 50°C, constant input voltage and load.
- (*7) Current limiting with automatic recovery. Avoid to operate over load or dead short for more than 30 seconds.
- (*8) Over voltage clamping by zener diode (on CH2 only).
- (*9) VDE class B with external capacitor.

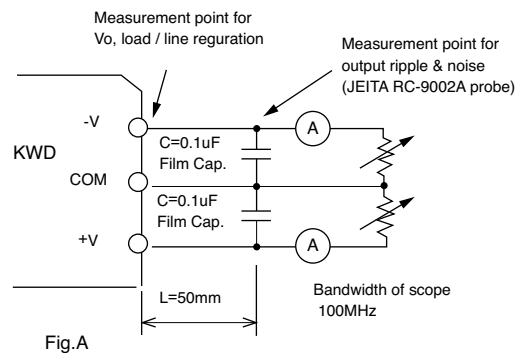

Output Derating

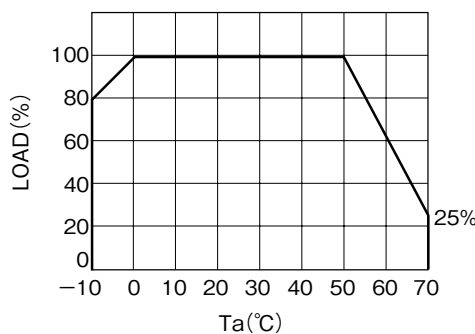

Outline Drawing

[KWD5]

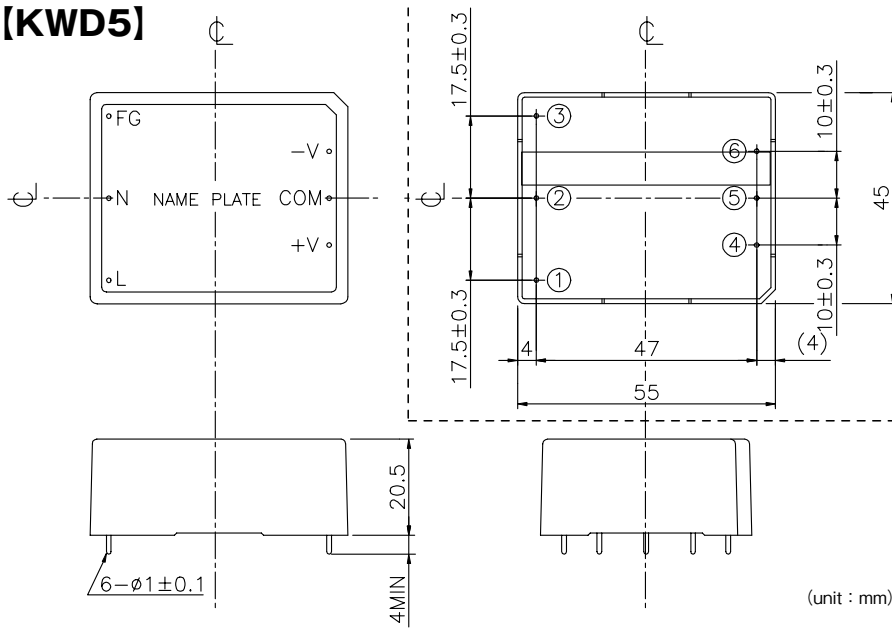

*TERMINAL ASSIGNMRNTS

- ①...FG
 - ②...AC (N)
 - ③...AC (L)
 - ④...-V
 - ⑤...COM
 - ⑥...+V
- INPUT
- OUTPUT

*MATERIAL
CASE : PLASTIC (UL94V-0)

KS
KWS
KWD

[KWD10]

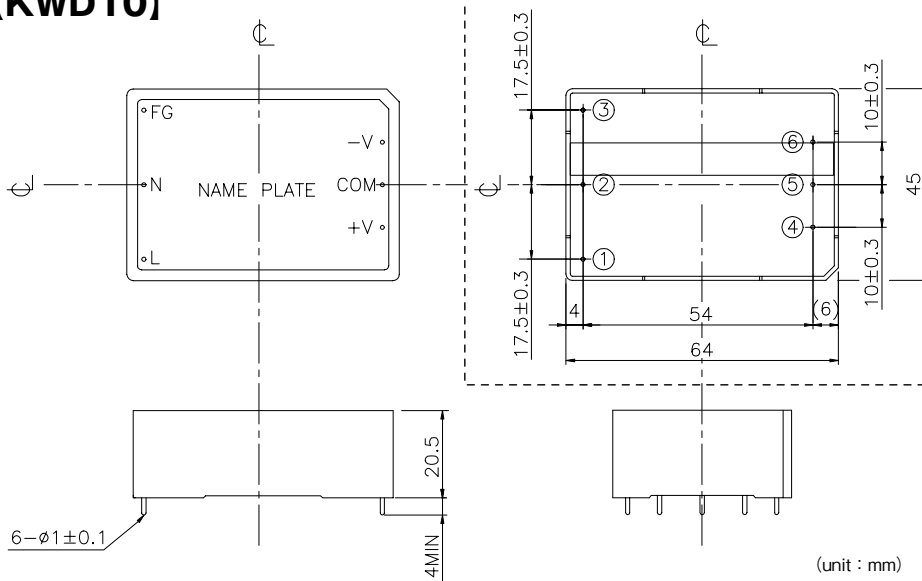

*TERMINAL ASSIGNMRNTS

- ①...FG
 - ②...AC (N)
 - ③...AC (L)
 - ④...-V
 - ⑤...COM
 - ⑥...+V
- INPUT
- OUTPUT

*MATERIAL
CASE : PLASTIC (UL94V-0)

[KWD15]

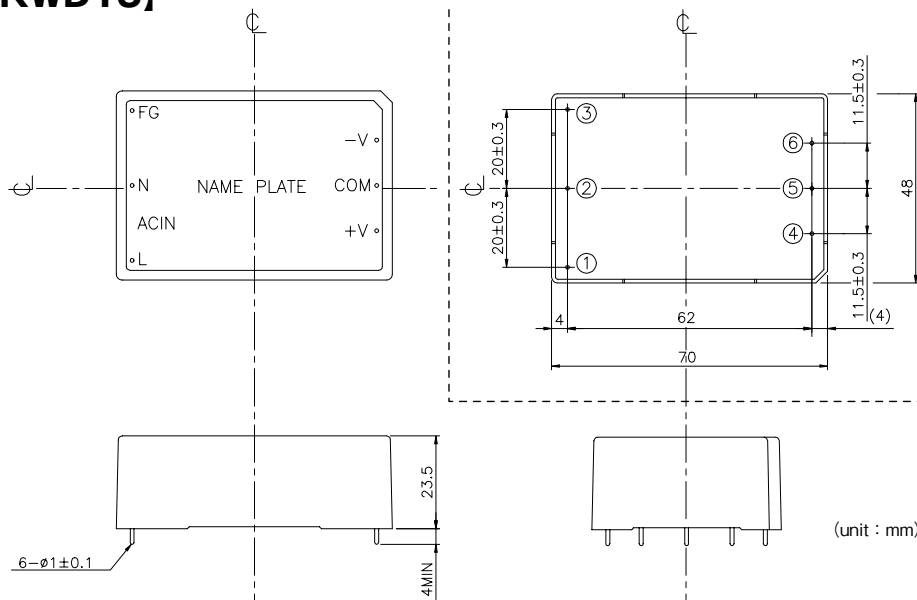

*TERMINAL ASSIGNMRNTS

- ①...FG
 - ②...AC (N)
 - ③...AC (L)
 - ④...-V
 - ⑤...COM
 - ⑥...+V
- INPUT
- OUTPUT

*MATERIAL
CASE : PLASTIC (UL94V-0)

KS/KWS/KWD Series Instruction Manual

BEFORE USING THE POWER SUPPLY UNIT

- Check that input/output terminals are correctly connected according to instruction manual.
- KWS/KWD series are designed for 85-265VAC continuous input. No need to switch operation to 100VAC or 200VAC input voltage.
- KS series is designed for 85-132VAC input. If a 200VAC is input, the power supply unit will be damaged.

1. Terminal Explanation

1 KS/KWS (single output)

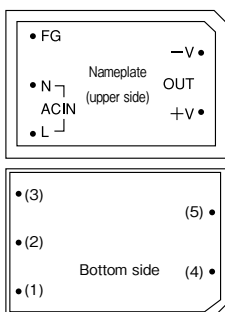

- | | |
|------------------|--|
| (1) FG: | Frame ground terminal for grounding |
| (2) AC IN (N): | AC input terminal (neutral line) |
| (3) AC IN (L): | AC input terminal (live line) fuse in line |
| (4) DC OUT (-V): | DC output terminal ("- " side) |
| (5) DC OUT (+V): | DC output terminal ("+" side) |

KS
KWS
KWD

2 KWD (dual outputs)

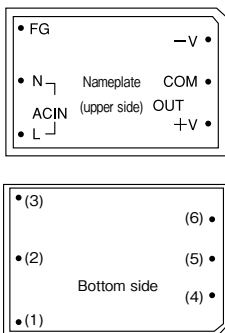

- | | |
|----------------|--|
| (1) FG: | Frame ground terminal for grounding |
| (2) AC IN (N): | AC input terminal (neutral line) |
| (3) AC IN (L): | AC input terminal (live line) fuse in line |
| (4) -V: | CH2 output terminal (-) |
| (5) COM: | Ground terminal of CH1 / CH2 |
| (6) +V: | CH1 output terminal (+) |

2. Terminal Connecting Method

1 KS/KWS (single output)

AC input
KS series: 85-132VAC
KWS series: 85-265VAC
(Continuous input type)

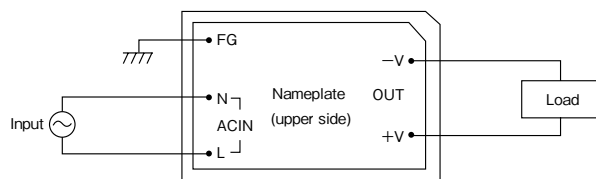

- A fuse in line of the power supply unit (L side of AC IN).
- KS series is designed for 85-132VAC input.
If a 200VAC is input, the unit may be damaged.
- KWS series is designed for 85-256VAC continuous input.
No need to switch.

2 KWD terminal (dual outputs)

AC input
85-265VAC
(Continuous input type)

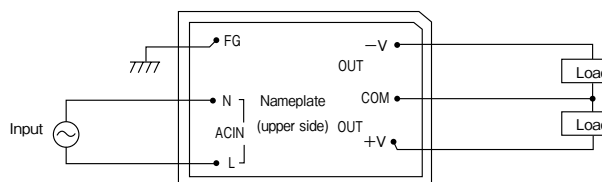

- A fuse in line of the power supply unit (L side of AC IN).
- KWD series is designed for 85-256VAC continuous input and the input switching operation is not necessary.

3. Explanation of Functions and Precautions

1 Over Current Protection (OCP)

OCP type is current limiting with automatic recovery. OCP function operates when the output current exceeds 105% or above of OCP specifications. The output automatically recovers when the over current / shorted conditions is removed. Do not operate under overload or dead short conditions for more than 30 seconds, which could result in damage to the unit.

2 Over Voltage Protection (OVP)

The over voltage protection (OVP) circuit with zener diode clamp system is built in. (In KWD series, OVP circuit is built into CH2 only.) Over 110% of nominal voltage will clamp the output. If the output voltage is lowered due to the over voltage application, the output will not resume. Replacement of the power supply unit is necessary.

3 Ripple

The maximum ripple voltage value in the specifications is measured in the ripple measurement circuit designated by JEITA RC-9131 probe. When the load wire is long, connect a film capacitor, etc., to prevent the ripple at the load terminal from becoming large. Note that the accurate measurement is not possible if the probe ground lead of the oscilloscope is long in measurement.

"Ripple measurement circuit"

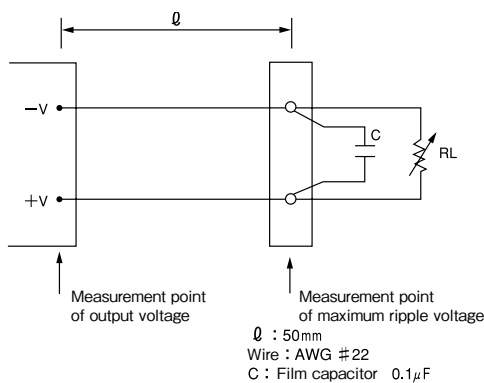

4 EMI

KWS and KWD series are built to meet the VDE Class B standards by adding external capacitor between L and N on the input side.

Refer to the recommended values below.

- KWS5, KWD5: AC250V 0.22 µF
- KWS10, KWD10: AC250V 0.22 µF
- KWS15, KWD15: AC250V 0.33 µF

5 Inrush Current

KS10 and KS15 use power thermistor to protect the circuit from inrush current. In power thermistor, the suppressed current value changes depending on the temperature, and the inrush current may become large in conditions with high temperature or when restarting input soon after stopping it.

6 Series/Parallel Operations

For series operation, either (A) or (B) is possible. Please connect a diode for by-pass when using method (A) of the series operation. Please use the diode whose rated forward current is equal or more than load current and the rated maximum reverse voltage is higher than the output voltage for each power supply.

● KS, KWS series

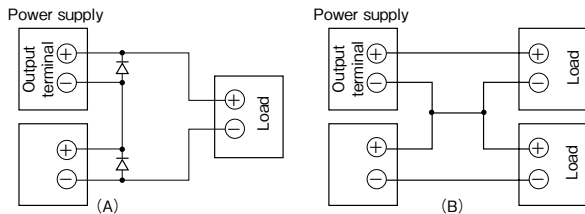

● KWD series

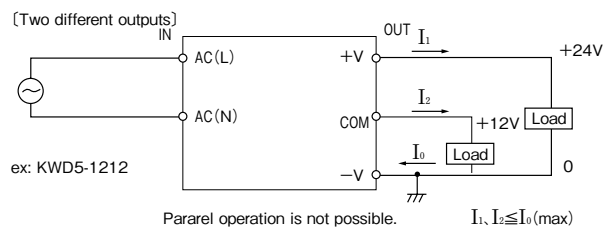
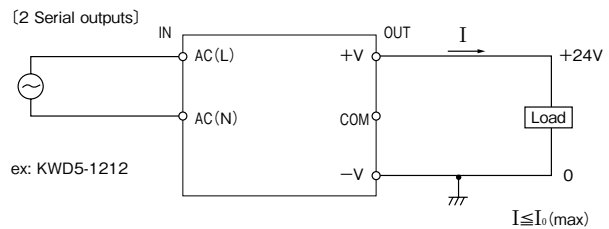
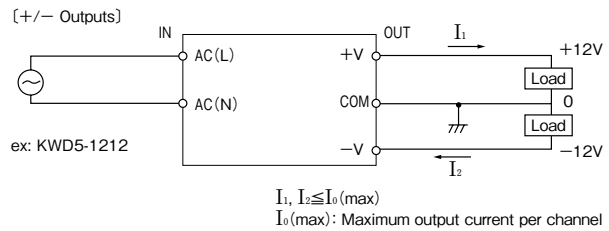

7 Isolation Test

The insulation resistance between output and FG is more than 100MΩ at 500VDC. For safety operation, voltage setting of DC isolation tester must be done before the test. Ensure that it is fully discharged after the test.

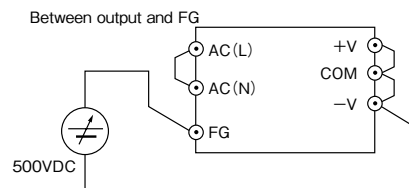

8 Withstand Voltage

This series is designed to withstand 2kVAC for between input and output, 2kVAC between input and FG, and 500VAC between output and FG each for 1 minute. When testing withstand voltage, set current limit or withstand voltage test equipment at 20mA. (Output-FG: 100mA)

The applied voltage must be gradually increased from zero to testing value and then gradually decrease for shut down. When timer is used, the power supply may be damaged by high impulse voltage at timer switch on and off. If a timer is used for measuring the test time, impulsive high voltage may be generated in applying and cutting off the voltage, causing damage to the unit.

* 3kVAC between input and output for KWS/KWD series

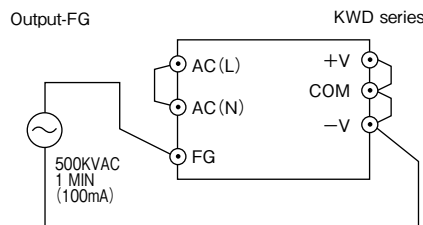
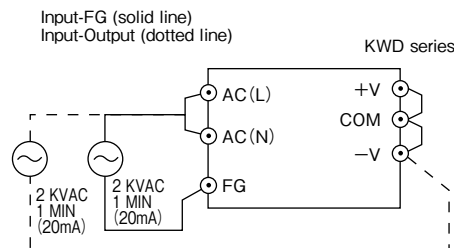

* For KS/KWS series, connect the +V and -V terminals of the output. (KS/KWS series are not equipped with the COM terminal.)

KS
KWS
KWD

4. Output Derating

There is no restriction on mounting direction but there should be enough consideration for airflow so that heat does not accumulate around the power module vicinity. Also note that the output derating is necessary when the ambient temperature is high, as shown in the figure in the right.

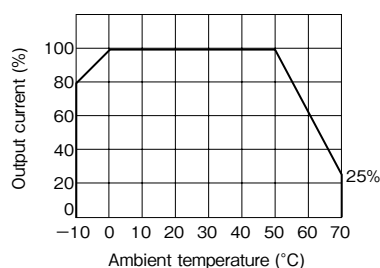

5. Recommended soldering/cleaning

1 Recommended soldering method

The temperature conditions in soldering should be the following.

- Dip condition: 260°C, within 10 seconds
- Pre-heat conditions: 110°C for 30-40 seconds
- Soldering iron: 350°C within 3 seconds

2 Recommended cleaning conditions

Recommended cleaning conditions after soldering are shown below.

- Cleaning solvent
IPA (isopropyl alcohol)
- Cleaning procedure

Cleaning should be conducted with a method that does not cause intrusion of the cleaning fluid into the inside of the power supply unit. (Note that if the cleaning fluid intrudes into inside of the power supply unit, the reliability of the power supply may be impaired.)

Note) Consult us if your cleaning method is other than that recommended above.

6. Before concluding power module damage

Check if the rated input voltage is connected.

Check if the wiring of input and output are correct.

Check if the pattern width connected to input/output is not too narrow.

Ensure that a large capacitor is not connected on the output side.

Please use within maximum capacitance shown below.

- KS5: 5V 100 μ F or lower, 12V 200 μ F or lower
- KS10: 5V 200 μ F or lower, 12V 400 μ F or lower
- KS15: 5V 400 μ F or lower, 12V 1,000 μ F or lower
- KWS5: 5V 2,000 μ F or lower, 12V/15V 200 μ F or lower
- KWS10: 5V 2,000 μ F or lower, 12V/15V 1,000 μ F or lower
- KWS15: 5V 2,000 μ F or lower, 12V/15V 1,000 μ F or lower
- KWD5: 800 μ F or lower
- KWD10: 1212 1,000 μ F or lower, 1515 500 μ F or lower
- KWD15: 1212 1,000 μ F or lower, 1515 1,000 μ F or lower

TDK-Lambda