

# ATV212HD22M3X

variable speed drive ATV212 - 22kW - 30hp -  
240V - 3ph - wo EMC - IP21



## Main

Device short name	ATV212
Product destination	Asynchronous motors
Phase	3 phase
Motor power kW	22 kW
Maximum Horse Power Rating	30 hp
Supply voltage limits	170...264 V
Supply frequency	50...60 Hz - 5...5 %
Line current	66.4 A 240 V 80.4 A 200 V
Range of Product	Altivar 212
Product or Component Type	Variable speed drive
Product Specific Application	Pumps and fans in HVAC
Communication Port Protocol	APOGEE FLN Modbus LonWorks BACnet METASYS N2
[Us] rated supply voltage	200...240 V - 15...10 %
EMC filter	Without EMC filter
IP degree of protection	IP21

## Complementary

Apparent power	33.5 kVA 240 V
Continuous output current	88 A 230 V
Maximum transient current	96.8 A 60 s
Speed drive output frequency	0.5...200 Hz
Speed range	1...10
Speed accuracy	+/- 10 % of nominal slip 0.2 Tn to Tn
Local signalling	For DC bus energized 1 LED (red)
Output voltage	<= power supply voltage
Isolation	Electrical between power and control
Type of cable	Without mounting kit 1 IEC cable 113 °F (45 °C), copper 90 °C / XLPE/EPR Without mounting kit 1 IEC cable 113 °F (45 °C), copper 70 °C / PVC With UL Type 1 kit 3 UL 508 cable 104 °F (40 °C), copper 75 °C / PVC
Electrical connection	VIA, VIB, FM, FLA, FLB, FLC, RY, RC, F, R, RES terminal 0.00 in <sup>2</sup> (2.5 mm <sup>2</sup> ) / AWG 14 L1/R, L2/S, L3/T terminal 0.08 in <sup>2</sup> (50 mm <sup>2</sup> ) / AWG 1/0
Tightening torque	5.31 Lbf.in (0.6 N.m) VIA, VIB, FM, FLA, FLB, FLC, RY, RC, F, R, RES) 212.42 lbf.in (24 N.m), 212 lb.in L1/R, L2/S, L3/T)
Supply	Internal supply for reference potentiometer (1 to 10 kOhm) 10.5 V DC +/- 5 %, <10 A overload and short-circuit protection Internal supply 24 V DC 21...27 V), <200 A overload and short-circuit protection
Sampling duration	2 Ms +/- 0.5 ms F discrete 2 Ms +/- 0.5 ms R discrete 2 Ms +/- 0.5 ms RES discrete 3.5 Ms +/- 0.5 ms VIA analog 22 ms +/- 0.5 ms VIB analog

The information provided in this documentation contains general descriptions and/or technical characteristics of the performance of the products contained herein. This documentation is not intended as a substitute for and is not to be used for determining suitability or reliability of these products for specific user applications. It is the duty of any such user or integrator to perform the appropriate and complete risk analysis, evaluation and testing of the products with respect to the relevant specific application or use thereof. Neither Schneider Electric Industries SAS nor any of its affiliates or subsidiaries shall be responsible or liable for misuse of the information contained herein.

Response time	FM 2 ms +/- 0.5 ms analog FLA, FLC 7 ms +/- 0.5 ms discrete FLB, FLC 7 ms +/- 0.5 ms discrete RY, RC 7 ms +/- 0.5 ms discrete
Accuracy	+/- 0.6 % (VIA) for a temperature variation 60 °C +/- 0.6 % (VIB) for a temperature variation 60 °C +/- 1 % (FM) for a temperature variation 60 °C
Linearity error	VIA +/- 0.15 % of maximum value input VIB +/- 0.15 % of maximum value input FM +/- 0.2 % output
Analogue output type	FM switch-configurable voltage 0...10 V DC 7620 Ohm 10 bits FM switch-configurable current 0...20 mA 970 Ohm 10 bits
Discrete output type	Configurable relay logic FLA, FLC) NO - 100000 cycles Configurable relay logic FLB, FLC) NC - 100000 cycles Configurable relay logic RY, RC) NO - 100000 cycles
Minimum switching current	3 mA 24 V DC configurable relay logic
Maximum switching current	5 A 250 V AC resistive cos phi = 1 L/R = 0 ms FL, R) 5 A 30 V DC resistive cos phi = 1 L/R = 0 ms FL, R) 2 A 250 V AC inductive cos phi = 0.4 L/R = 7 ms FL, R) 2 A 30 V DC inductive cos phi = 0.4 L/R = 7 ms FL, R)
Discrete input type	F programmable 24 V DC level 1 PLC 4700 Ohm R programmable 24 V DC level 1 PLC 4700 Ohm RES programmable 24 V DC level 1 PLC 4700 Ohm
Discrete input logic	Positive logic (source) F, R, RES), <= 5 V, >= 11 V Negative logic (sink) F, R, RES), >= 16 V, <= 10 V
Dielectric strength	2830 V DC between earth and power terminals 4230 V DC between control and power terminals
Insulation resistance	>= 1 mOhm 500 V DC for 1 minute
Frequency resolution	Display unit 0.1 Hz Analog input 0.024/50 Hz
Communication Service	Write multiple registers (16) 2 words maximum Time out setting from 0.1 to 100 s Write single register (06) Monitoring inhabitable Read device identification (43) Read holding registers (03) 2 words maximum
Option card	Communication card LonWorks
Power dissipation in W	763 W
Air flow	68950.14 Gal/hr(US) (261 m3/h)
Specific application	HVAC
Variable speed drive application selection	Building - HVAC Compressor for scroll Building - HVAC Fan Building - HVAC Pump
Motor power range AC-3	15...25 kW 200...240 V 3 phase
Motor starter type	Variable speed drive
Discrete output number	2
Analogue input number	2
Analogue input type	VIA switch-configurable voltage 0...10 V DC 24 V max 30000 Ohm 10 bits VIB configurable voltage 0...10 V DC 24 V max 30000 Ohm 10 bits VIB configurable PTC probe 0...6 probes 1500 Ohm VIA switch-configurable current 0...20 mA 250 Ohm 10 bits
Analogue output number	1
Physical interface	2-wire RS 485
Connector type	1 open style 1 RJ45
Transmission Rate	9600 bps or 19200 bps
Transmission frame	RTU
Number of addresses	1...247
Data format	8 bits, 1 stop, odd even or no configurable parity
Type of polarization	No impedance
Asynchronous motor control profile	Voltage/Frequency ratio, automatic IR compensation (U/f + automatic Uo) Voltage/Frequency ratio, 5 points Flux vector control without sensor, standard Voltage/Frequency ratio, 2 points Voltage/frequency ratio - Energy Saving, quadratic U/f
Torque accuracy	+/- 15 %

Transient overtorque	120 % of nominal motor torque +/- 10 % 60 s
Acceleration and deceleration ramps	Automatic based on the load Linear adjustable separately from 0.01 to 3200 s
Motor slip compensation	Automatic whatever the load Adjustable Not available in voltage/frequency ratio motor control
Switching frequency	6...16 kHz adjustable 8...16 kHz with derating factor
Nominal switching frequency	8 kHz
Braking to standstill	By DC injection
Network Frequency	47.5...63 Hz
Prospective line Isc	22 kA
Protection type	Overheating protection drive Thermal power stage drive Short-circuit between motor phases drive Input phase breaks drive Overcurrent between output phases and earth drive Overvoltages on the DC bus drive Break on the control circuit drive Against exceeding limit speed drive Line supply overvoltage and undervoltage drive Line supply undervoltage drive Against input phase loss drive Thermal protection motor Motor phase break motor With PTC probes motor
Width	9.45 in (240 mm)
Height	16.54 in (420 mm)
Depth	8.43 in (214 mm)
Net Weight	60.41 lb(US) (27.4 kg)

## Environment

Pollution degree	3 IEC 61800-5-1
IP degree of protection	IP20 on upper part without blanking plate on cover EN/IEC 61800-5-1 IP20 on upper part without blanking plate on cover EN/IEC 60529 IP21 EN/IEC 61800-5-1 IP21 EN/IEC 60529 IP41 on upper part EN/IEC 61800-5-1 IP41 on upper part EN/IEC 60529
Vibration resistance	1.5 mm 3...13 Hz)EN/IEC 60068-2-6 1 gn 13...200 Hz)EN/IEC 60068-2-8
Shock resistance	15 gn 11 ms IEC 60068-2-27
Environmental characteristic	Classes 3C1 IEC 60721-3-3 Classes 3S2 IEC 60721-3-3
Noise level	59.9 dB 86/188/EEC
Operating altitude	3280.84...9842.52 ft (1000...3000 m) limited to 2000 m for the Corner Grounded distribution network with current derating 1 % per 100 m <= 3280.84 ft (1000 m) without derating
Relative humidity	5...95 % without condensation IEC 60068-2-3 5...95 % without dripping water IEC 60068-2-3
Ambient air temperature for operation	14...104 °F (-10...40 °C) without derating) 104...122 °F (40...50 °C) with derating factor)
Operating position	Vertical +/- 10 degree
Product Certifications	NOM 117 UL C-tick CSA
Marking	CE

Standards	EN 61800-3 environments 2 category C1 IEC 61800-3 environments 2 category C1 EN 61800-3 environments 1 category C1 IEC 61800-5-1 IEC 61800-3 environments 2 category C2 EN 61800-5-1 EN 61800-3 environments 1 category C2 IEC 61800-3 environments 1 category C2 EN 61800-3 environments 2 category C3 IEC 61800-3 environments 2 category C3 IEC 61800-3 EN 61800-3 environments 1 category C3 EN 61800-3 IEC 61800-3 environments 1 category C3 UL Type 1 EN 61800-3 environments 2 category C2 IEC 61800-3 environments 1 category C1
Assembly style	With heat sink
Electromagnetic compatibility	Electrostatic discharge immunity test level 3 IEC 61000-4-2 Radiated radio-frequency electromagnetic field immunity test level 3 IEC 61000-4-3 Electrical fast transient/burst immunity test level 4 IEC 61000-4-4 1.2/50 µs - 8/20 µs surge immunity test level 3 IEC 61000-4-5 Conducted radio-frequency immunity test level 3 IEC 61000-4-6 Voltage dips and interruptions immunity test IEC 61000-4-11
Regulation loop	Adjustable PI regulator
Ambient Air Temperature for Storage	-13...158 °F (-25...70 °C)

## Ordering and shipping details

Category	22156 - ATV212 30 - 40 HP 230 VOLT
Discount Schedule	CP4D
GTIN	3606480322426
Nbr. of units in pkg.	1
Package weight(Lbs)	55.12 lb(US) (25 kg)
Returnability	Yes
Country of origin	FR

## Packing Units

Unit Type of Package 1	PCE
Package 1 Height	14.37 in (36.5 cm)
Package 1 width	15.55 in (39.5 cm)
Package 1 Length	23.62 in (60 cm)

## Offer Sustainability

Sustainable offer status	Green Premium product
California proposition 65	WARNING: This product can expose you to chemicals including: Lead and lead compounds, which is known to the State of California to cause cancer and birth defects or other reproductive harm. For more information go to <a href="http://www.P65Warnings.ca.gov">www.P65Warnings.ca.gov</a>
REACH Regulation	<a href="#">REACH Declaration</a>
EU RoHS Directive	Pro-active compliance (Product out of EU RoHS legal scope) <a href="#">EU RoHS Declaration</a>
Mercury free	Yes
RoHS exemption information	<a href="#">Yes</a>
China RoHS Regulation	<a href="#">China RoHS Declaration</a>
Environmental Disclosure	<a href="#">Product Environmental Profile</a>
Circularity Profile	<a href="#">End Of Life Information</a>
WEEE	The product must be disposed on European Union markets following specific waste collection and never end up in rubbish bins.

## Contractual warranty

---

Warranty	18 months
----------	-----------

---

Dimensions

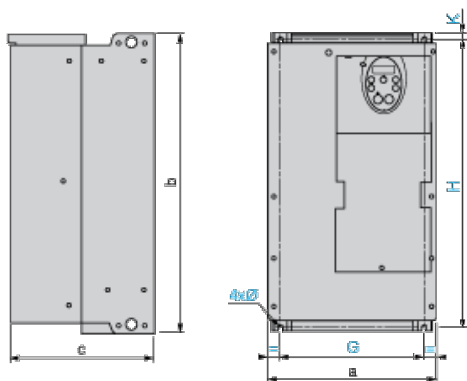

Dimensions in mm

ATV212H	a	b	c	G	H	K	Ø
D22M3X D22N4, D30N4	240	420	214	206	403	10	6
D37N4, D45N4	240	550	244	206	529	10	6

Dimensions in in.

ATV212H	a	b	c	G	H	K	Ø
D22M3X D22N4, D30N4	9.45	16.54	8.43	8.11	15.87	0.39	0.24
D37N4, D45N4	9.45	21.65	9.60	8.11	20.83	0.39	0.24

EMC mounting plate (supplied with drive)

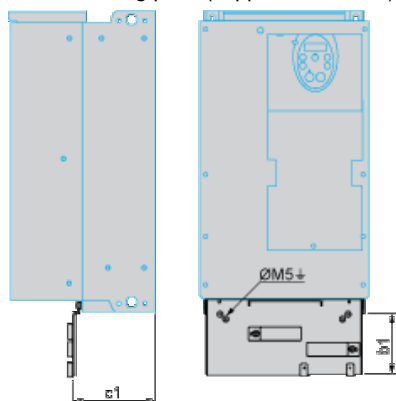

Dimensions in mm

ATV212H	b1	c1
D22M3X D22N4, D30N4	122	120
D37N4, D45N4	113	127

Dimensions in in.

ATV212H	b1	c1
D22M3X D22N4, D30N4	4.80	4.72
D37N4, D45N4	4.45	5.00

## Mounting Recommendations

### Clearance

Depending on the conditions in which the drive is to be used, its installation will require certain precautions and the use of appropriate accessories.

Install the unit vertically:

- Do not place it close to heating elements.
- Leave sufficient free space to ensure that the air required for cooling purposes can circulate from bottom to the top of the unit.

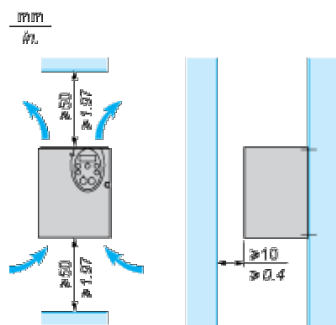

### Mounting Types

Type A mounting

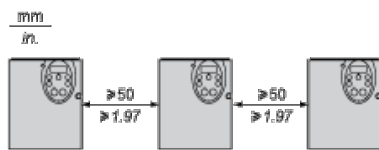

Type B mounting

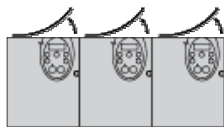

Type C mounting

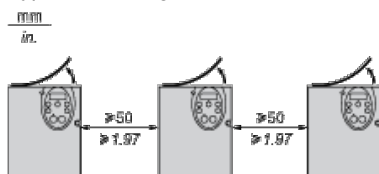

By removing the protective blanking cover from the top of the drive, the degree of protection for the drive becomes IP21. The protective blanking cover may vary according to the drive model, see opposite.

### Specific Recommendations for Mounting in an Enclosure

To help ensure proper air circulation in the drive:

- Fit ventilation grilles.
- Check that there is sufficient ventilation. If there is not, install a forced ventilation unit with a filter. The openings and/or fans must provide a flow rate at least equal to that of the drive fans (refer to the product characteristics).

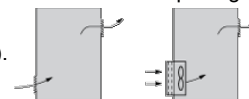

- Use special filters with UL Type 12/IP54 protection.
- Remove the blanking cover from the top of the drive.

### Sealed Metal Enclosure (IP54 Degree of Protection)

The drive must be mounted in a dust and damp proof enclosure in certain environmental conditions, such as dust, corrosive gases, high humidity with risk of condensation and dripping water, splashing liquid, etc. This enables the drive to be used in an enclosure where the maximum internal temperature reaches 50°C.



Recommended Wiring Diagram

3-Phase Power Supply

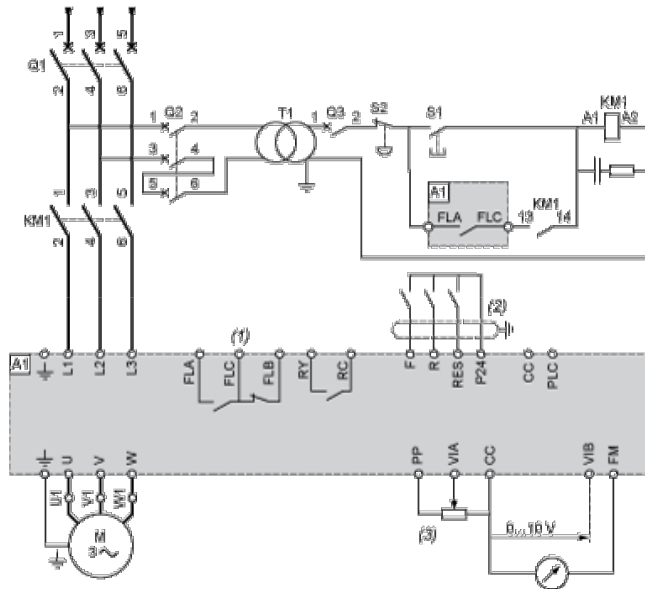

- A1: ATV 212 drive
- KM1: Contactor
- Q1: Circuit breaker
- Q2: GV2 L rated at twice the nominal primary current of T1
- Q3: GB2CB05
- S1, XB4 B or XB5 A pushbuttons
- S2:
- T1: 100 VA transformer 220 V secondary
- (1) Fault relay contacts for remote signalling of the drive status
- (2) Connection of the common for the logic inputs depends on the positioning of the switch (Source, PLC, Sink)
- (3) Reference potentiometer SZ1RV1202

NOTE: All terminals are located at the bottom of the drive. Install interference suppressors on all inductive circuits near the drive or connected on the same circuit, such as relays, contactors, solenoid valves, fluorescent lighting, etc.

Switches (Factory Settings)

Voltage/current selection for analog I/O (VIA and VIB)



Voltage/current selection for analog I/O (FM)



Selection of logic type



- (1) negative logic
- (2) positive logic

Other Possible Wiring Diagrams

## Logic Inputs According to the Position of the Logic Type Switch

“Source” position

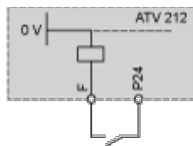

“Sink” position

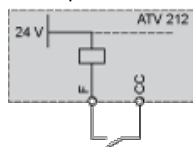

“PLC” position with PLC transistor outputs	
<p>(1) PLC</p>	<p>(1) PLC</p>

2-wire control

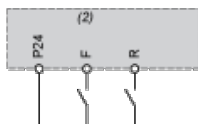

F: Forward

R: Preset speed

(2) ATV 212 control terminals

3-wire control

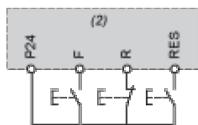

F: Forward

R: Stop

RES: Reverse

(2) ATV 212 control terminals

PTC probe

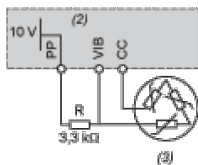

(2) ATV 212 control terminals

(3) Motor

## Analog Inputs

Voltage analog inputs

External +10 V	
<p>(2) ATV 212 control terminals (4) Speed reference potentiometer 2.2 to 10 kΩ</p>	<p>(2) ATV 212 control terminals</p>

Analog input configured for current: 0-20 mA, 4-20 mA, X-Y mA

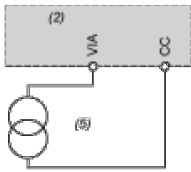

(2) ATV 212 control terminals

(5) Source 0-20 mA, 4-20 mA, X-Y mA

Analog input VIA configured as positive logic input ("Source" position)



(2) ATV 212 control terminals

Analog input VIA configured as negative logic input ("Sink" position)

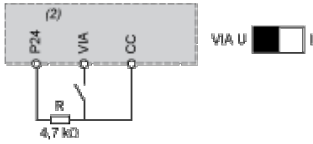

(2) ATV 212 control terminals

Derating Curves

The derating curves for the drive nominal current ( $I_n$ ) depend on the temperature, the switching frequency and the mounting type (A, B or C). For intermediate temperatures (45°C for example), interpolate between 2 curves.

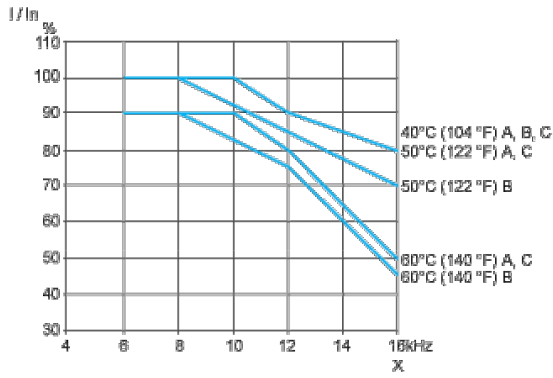

X Switching frequency