

PART NAME

UTILIBOX (STYLE L)

PART No.

CU-1937-MB

REVISION DATE

1-3-11

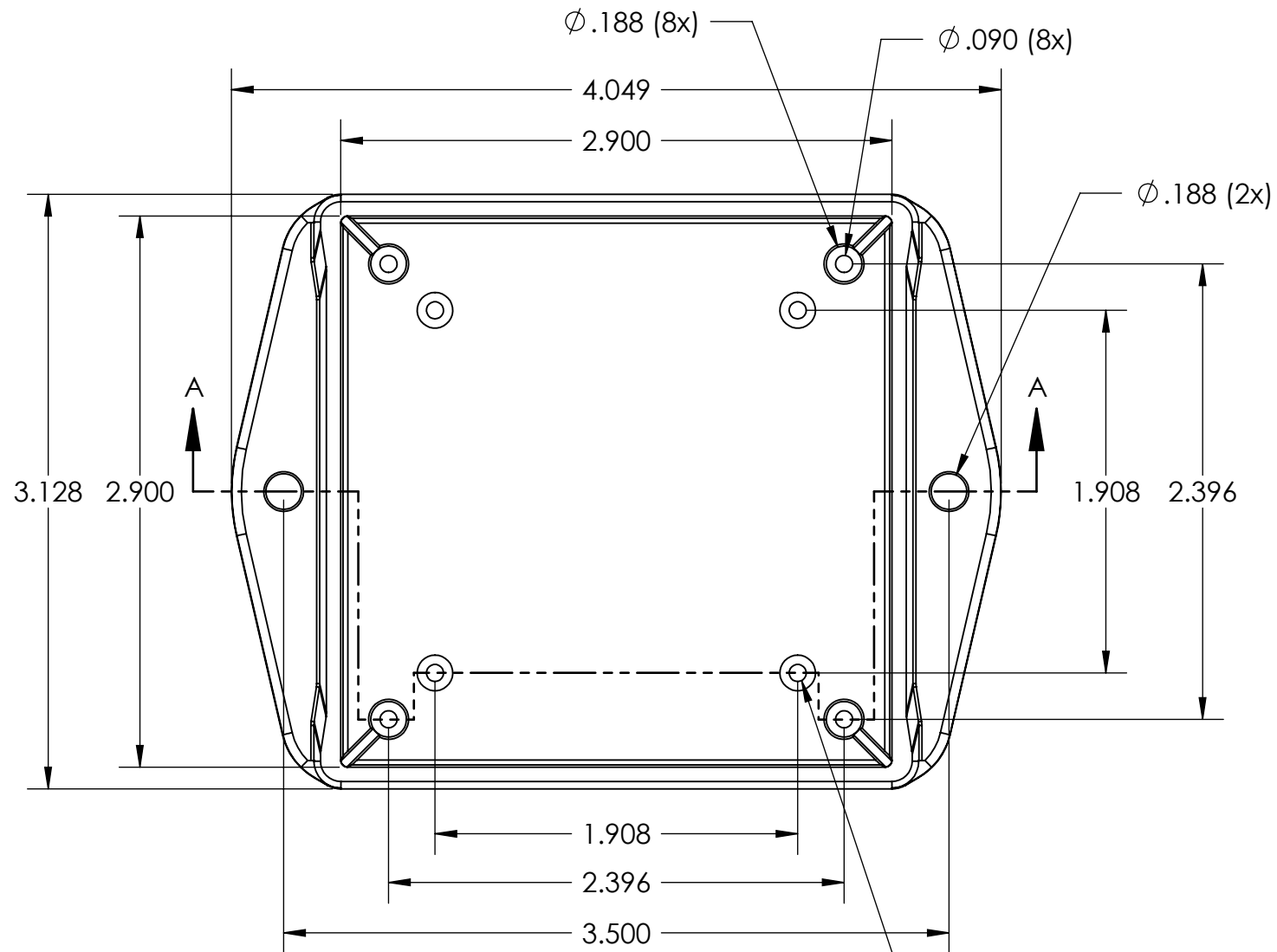

**COVER NOT SHOWN
THIS VIEW ONLY**

PC BOARD MOUNTING BOSSES
ACCEPT #4 x 1/4" LG
THREAD FORMING SCREWS
(NOT SUPPLIED)

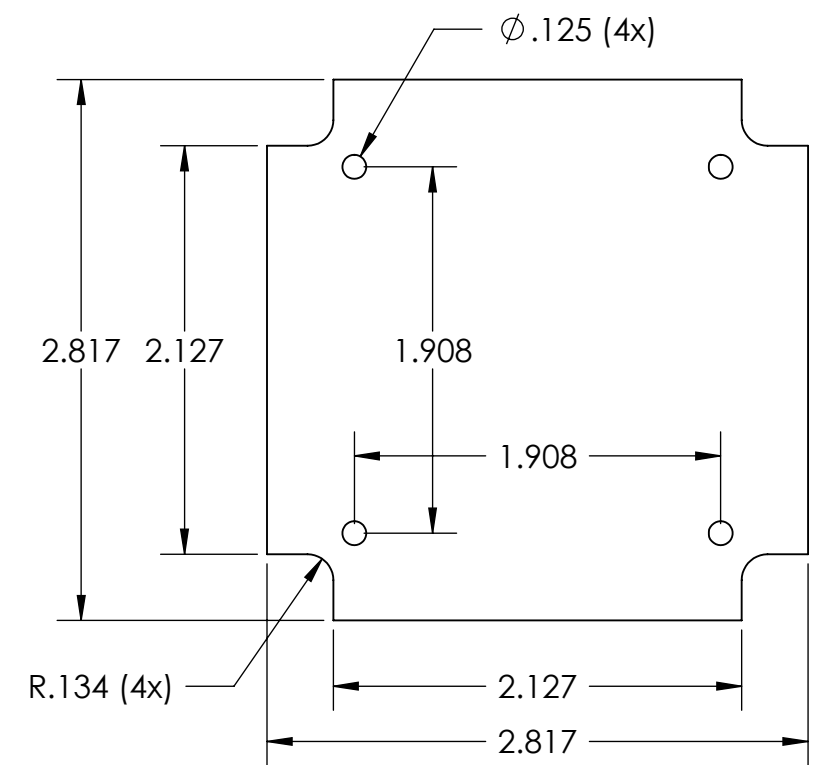
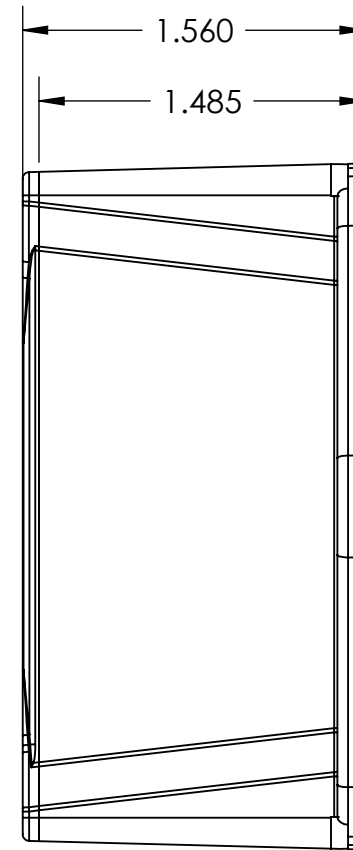

**SUGGESTED PC BOARD
LAYOUT**

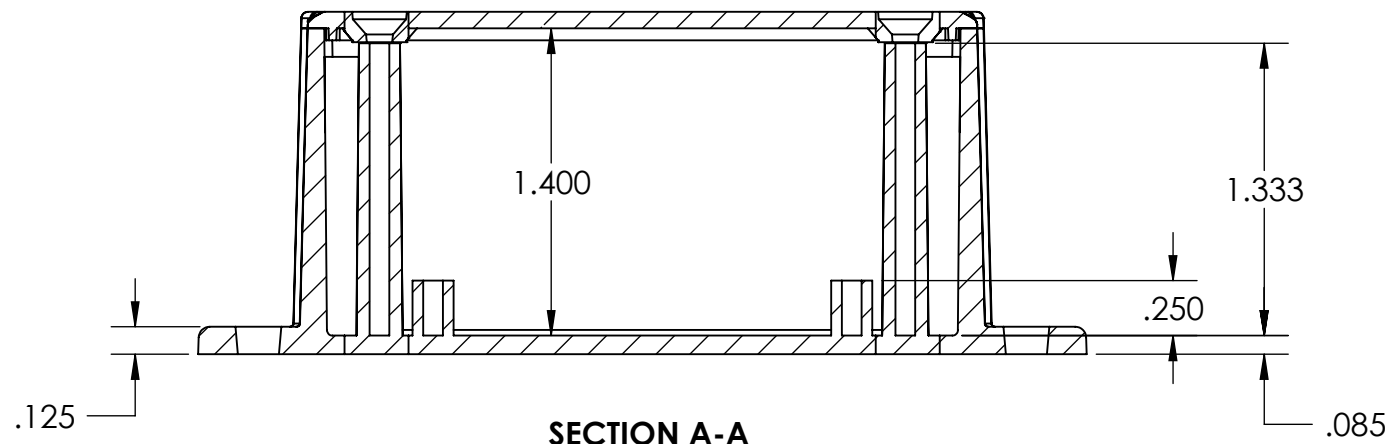

SECTION A-A

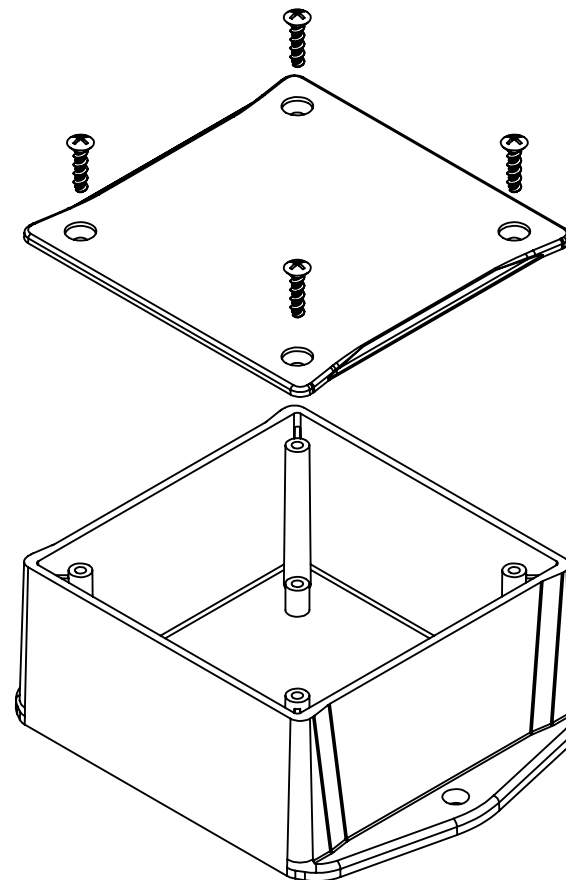

MATERIAL: ABS UL94V-0, BLACK

NOTES:

- 1.) FOUR (4) #4-24 x 1/2" LG. THREAD FORMING SCREWS SUPPLIED FOR ASSEMBLY OF COVER TO BODY.
- 2.) ALL DIMENSIONS HAVE $\pm .015$ TOLERANCE
- 3.) ALL OUTSIDE AND INSIDE DRAFT ANGLE: $.5^\circ \pm .5^\circ$