

TOSHIBA CMOS Linear Integrated Circuit Silicon Monolithic

TCK42xG Series

Over Voltage Protection MOSFET Gate Driver IC

1. Description

TCK42xG series is Over Voltage Protection Gate Driver IC for External N-channel MOSFET. This product support to MOSFET operating in wide voltage line from 2.7 V to 28 V with various Over Voltage Lock Out lineups. And this features low standby current, less than 1 μA , built in charge pump circuit and MOSFET gate-source protection circuit. Package is very small and thin WCSP6G (1.2 mm x 0.8 mm (typ.), t: 0.35 mm (max)). Thus this is suitable for mobile, wearable system and power management circuit such as load switch application.

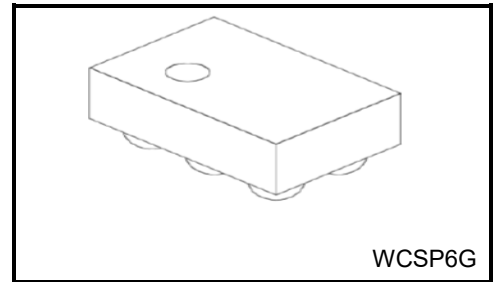

Weight : 0.61 mg (typ.)

2. Applications

Load switch circuit for mobile, wearable, and IoT equipment

3. Features

- Gate driver for N-channel Common Drain MOSFET
- Gate driver for N-channel Single High side MOSFET
- High maximum input voltage: $V_{\text{IN max}} = 40 \text{ V}$
- Wide input voltage operation: $V_{\text{IN}} = 2.7 \text{ to } 28 \text{ V}$
- Gate-Source protection circuit
- Over Voltage Lock Out : $V_{\text{IN_OVLO}} = 6.31 \text{ V}, 10.83 \text{ V}, 14.29 \text{ V}, 23.26 \text{ V}$ and 27.73 V typ
- Under Voltage Lock Out : $V_{\text{IN_UVLO}} = 2.0 \text{ V typ}$
- Built in Charge pump circuit: Gate source voltage $V_{\text{GS}} = 5.6 \text{ V}$ and 10 V typ
- Low standby current : $I_{\text{Q(OFF)}} = 0.9 \mu\text{A max}$ at $V_{\text{IN}} = 12 \text{ V}$ (Except TCK424G, TCK425G)

Start of commercial production
2021-11

4. Absolute Maximum Ratings (Note)

Characteristics	Symbol	Rating	Unit
Input voltage	V _{IN}	-0.3 to 40	V
Output voltage	V _{OUT}	-0.3 to 40	V
Control voltage	V _{CT}	-0.3 to 6	V
Output GATE voltage	V _{GATE1,2}	-0.3 to 40	V
Power dissipation	P _D	800 (Note 1)	mW
Operating temperature range	T _{opr}	-40 to 85	°C
Junction temperature	T _j	150	°C
Storage temperature	T _{stg}	-55 to 150	°C

Note: Using continuously under heavy loads (e.g. the application of high temperature/current/voltage and the significant change in temperature, etc.) may cause this product to decrease in the reliability significantly even if the operating conditions (i.e. operating temperature/current/voltage, etc.) are within the absolute maximum ratings. Please design the appropriate reliability upon reviewing the Toshiba Semiconductor Reliability Handbook (“Handling Precautions”/“Derating Concept and Methods”) and individual reliability data (i.e. reliability test report and estimated failure rate, etc).

Note1: Rating at mounting on a board: FR4 board. (40 mm × 40 mm × 1.6 mm, Cu 4 layer)

5. Top Marking, Pin Assignment (top view)

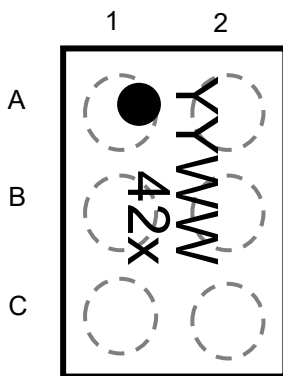

A1: VGATE1
 B1: VGATE2
 C1: VOUT
 A2: VIN
 B2: GND
 C2: VCT

YYWW: Lot No.

42x: Device name code
 420: TCK420G
 421: TCK421G
 422: TCK422G
 423: TCK423G
 424: TCK424G
 425: TCK425G

6. Operating Ranges

Characteristics	Symbol	Min.	Typ.	Max.	Unit
Input operation voltage	V_{IN_opr} (Note 2)	2.7	—	28	V
CONTROL High-level input voltage	V_{IH}	1.2	—	5.5	V
CONTROL Low-level input voltage	V_{IL}	—	—	0.4	V

Note 2: $V_{IN_opr} < V_{IN_OVLO\ Max}$ of each product

7. List of Products Number, OVLO and VGS

Product number	OVLO threshold, falling typ (V)	External MOSFET Gate-Source voltage (Control ON) typ (V)
TCK420G	27.73	10
TCK421G	23.26	10
TCK422G	14.29	10
TCK423G	14.29	5.6
TCK424G	10.83	5.6
TCK425G	6.31	5.6

8. Block Diagram

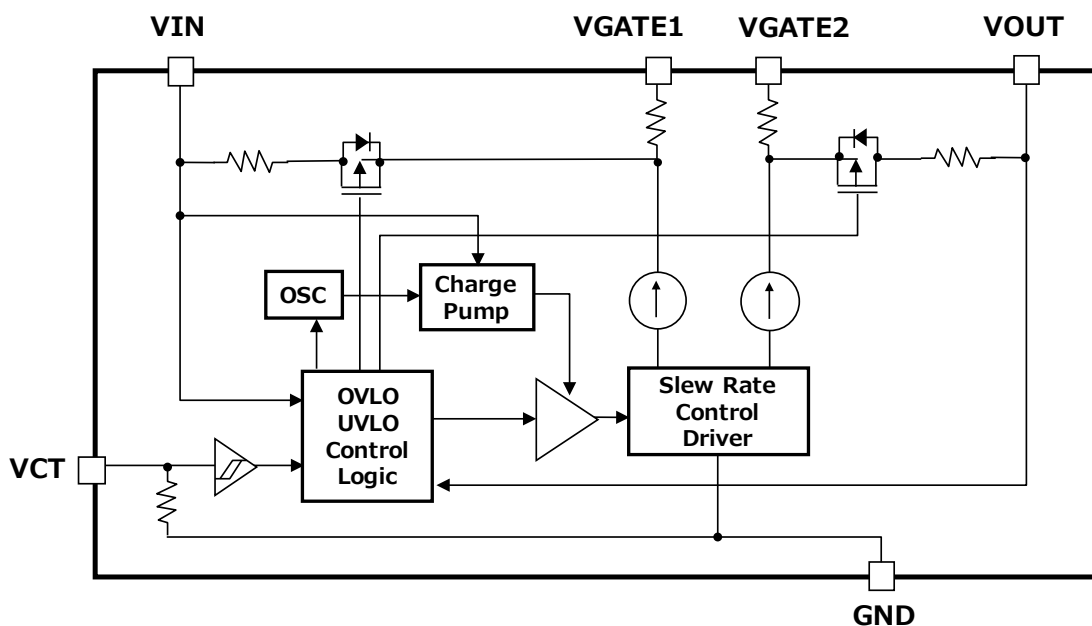

9. PIN Description

PIN	Name	Description
A1	VGATE1	Gate Driver Output for Gate 1 Or OPEN state (Non connection) for Single MOSFET use case
B1	VGATE2	Gate Driver Output for Gate 2
C1	VOUT	Monitoring Output voltage Connecting Output (Source 2) of Common Drain MOSFET Or Connecting Output (Source) of single MOSFET use case
A2	VIN	Input power supply voltage Connecting Output (Source 1) of Common Drain MOSFET Or Connecting Output (Drain) of single MOSFET use case
B2	GND	Ground
C2	VCT	Mode control input terminal VCT=High turn the external MOSFETs ON, VCT=Low, turn the external MOSFETs OFF

10. Operation Table

$2.7V \leq V_{IN} \leq 28 V$ ($T_a = -40$ to $85^\circ C$)

VCT	VGATE1, VGATE2
High	Driver ON mode
Open	Driver OFF mode
Low	

11. Electrical Characteristics

11.1. DC Characteristics (Ta = -40 to 85°C)

Characteristics	Symbol	Test Condition	Ta = 25°C			Ta = -40 to 85°C (Note 3)		Unit			
			Min.	Typ.	Max.	Min.	Max.				
VIN UVLO threshold, VOUT falling	VIN_UVLO	—	—	2.0	—	—	2.5	V			
VIN UVLO hysteresis	VIN_UVhyst	—	—	0.2	—	—	—	V			
VIN OVLO threshold, VOUT falling	TCK420G	VIN_OVLO	—	27.73	—	26.50	28.50	V			
	TCK421G		—	23.26	—	22.34	24.05	V			
	TCK422G TCK423G		—	14.29	—	13.61	14.91	V			
	TCK424G		—	10.83	—	10.35	11.47	V			
	TCK425G		—	6.31	—	5.76	6.87	V			
VIN OVLO hysteresis	TCK420G	VIN_OVhyst	—	0.17	—	—	—	V			
	TCK421G TCK422G TCK423G TCK424G TCK425G		—	0.12	—	—	—	V			
	Input quiescent current (ON state)		TCK420G TCK421G TCK422G	IQ(ON)	VCT: High, VIN = 2.7 V	—	140	—	—	200	μA
					VCT: High, VIN = 4 V	—	130	—	—	420	μA
					VCT: High, VIN = 5 V	—	140	—	—	300	μA
VCT: High, VIN = 9 V		—			170	—	—	460	μA		
VCT: High, VIN = 12 V		—			185	—	—	490	μA		
VCT: High, VIN = 20 V (Except TCK422G)		—	220		—	—	560	μA			
TCK423G TCK424G TCK425G		VCT: High, VIN = 2.7 V	—		75	—	—	130	μA		
		VCT: High, VIN = 4 V	—		95	—	—	150	μA		
		VCT: High, VIN = 5 V	—		100	—	—	160	μA		
		VCT: High, VIN = 9 V (Except TCK425G)	—		125	—	—	200	μA		
	VCT: High, VIN = 12 V (TCK423G only)	—	140	—	—	225	μA				
Standby current (OFF state)	IQ(OFF)	VCT: Low, VIN = 2.7 V	—	0.14	—	—	0.3	μA			
		VCT: Low, VIN = 4 V	—	0.25	—	—	0.4	μA			
		VCT: Low, VIN = 5 V	—	0.28	—	—	0.5	μA			
		VCT: Low, VIN = 9 V (Except TCK425G)	—	0.42	—	—	0.7	μA			
		VCT: Low, VIN = 12 V (Except TCK424G, TCK425G)	—	0.52	—	—	0.9	μA			
		VCT: Low, VIN = 20 V (TCK420G and TCK421G)	—	0.80	—	—	1.3	μA			

11.1. DC Characteristics (Ta = -40 to 85°C) (continued)

Characteristics	Symbol	Test Condition	Ta = 25°C			Ta = -40 to 85°C (Note 3)		Unit	
			Min.	Typ.	Max.	Min.	Max.		
GATE Drive voltage (VGATE1-VIN) (VGATE2-VOUT)	TCK420G TCK421G TCK422G	VGS (Note 4)	VIN = 2.7 V	—	9.2	—	8	10	V
			VIN = 5 V	—	10	—	9	11	V
			VIN = 9 V	—	10	—	9	11	V
			VIN = 12 V	—	10	—	9	11	V
			VIN = 20 V (Except TCK422G)	—	10	—	9	11	V
			VIN = 24 V (TCK420G only)	—	10	—	9	11	V
	TCK423G TCK424G TCK425G		VIN = 2.7 V	—	5.6	—	4.9	6.3	V
			VIN = 5 V	—	5.6	—	5.0	6.3	V
			VIN = 9 V (Except TCK425G)	—	5.6	—	5.0	6.3	V
			VIN = 12 V (TCK423G only)	—	5.6	—	5.0	6.3	V
Control pull down resistance	RCT	VCT = 5 V	—	550	—	—	—	kΩ	

Note 3: This parameter is warranted by design

Note 4: VIN is stable power supply condition

11.2. AC Characteristics (Ta = 25°C, VIN = 5 V, CGATE1,2 (Note 5) = 4000 pF)

Characteristics		Symbol	Test Condition (Figure 2,3,4)	Min.	Typ.	Max.	Unit
VGS ON time		tON	Initial startup time VGATE2 - VOUT = 1 V after VCT = High, IOUT = 0 mA	—	2.9	—	ms
VGS OFF time	TCK420G TCK421G TCK422G	tOFF	VGATE2 - VOUT = 1 V, after VCT = Low, IOUT = 0 mA	—	52	—	μs
	TCK423G TCK424G TCK425G			—	23	—	μs

11.3. AC Characteristics (Ta = 25°C, VIN = 12 V, CGATE1,2 (Note 5) = 4000 pF)

Characteristics		Symbol	Test Condition (Figure 2,3,4)	Min.	Typ.	Max.	Unit
VGS ON time		tON	Initial startup time VGATE2 - VOUT = 1 V after VCT = High, IOUT = 0 mA	—	2.9	—	ms
VGS OFF time	TCK420G TCK421G TCK422G	tOFF	VGATE2 - VOUT = 1 V, after VCT = Low, IOUT = 0 mA	—	44	—	μs
	TCK423G			—	16.4	—	μs

TCK420G, TCK421G

11.4. AC Characteristics (Ta = 25°C, VIN = 20 V, CGATE1,2 (Note 5) = 4000 pF)

Characteristics		Symbol	Test Condition (Figure 2,3,4)	Min.	Typ.	Max.	Unit
VGS ON time		tON	Initial startup time VGATE2 - VOUT = 1 V after VCT = High, IOUT = 0 mA	—	2.9	—	ms
VGS OFF time		tOFF	VGATE2 - VOUT = 1 V, after VCT = Low, IOUT = 0 mA	—	36	—	μs

TCK420G

11.5. AC Characteristics (Ta = 25°C, VIN = 24 V, CGATE1,2 (Note 5) = 4000 pF)

Characteristics		Symbol	Test Condition (Figure 2,3,4)	Min.	Typ.	Max.	Unit
VGS ON time		tON	Initial startup time VGATE2 - VOUT = 1 V after VCT = High, IOUT = 0 mA	—	2.9	—	ms
VGS OFF time		tOFF	VGATE2 - VOUT = 1 V, after VCT = Low, IOUT = 0 mA	—	32	—	μs

11.6. AC Characteristics (Ta = 25°C, C_{GATE1,2} (Note 5) = 4000 pF)

Characteristics		Symbol	Test Condition (Figure 5,6)	Min.	Typ.	Max.	Unit
OVLO V _{GS} turn OFF time	TCK420G	t _{OVLP}	V _{IN} = 24 to 29 V, V _{IN} rising = 2 V/μs V _{GS} typ to V _{GS} (V _{GATE2} -V _{IN}) = 1 V I _{OUT} = 0 mA	—	31	—	μs
	TCK421G		V _{IN} = 20 to 25 V, V _{IN} rising = 2 V/μs V _{GS} typ to V _{GS} (V _{GATE2} -V _{IN}) = 1 V I _{OUT} = 0 mA	—	34	—	μs
	TCK422G		V _{IN} = 12 to 15 V, V _{IN} rising = 2 V/μs V _{GS} typ to V _{GS} (V _{GATE2} -V _{IN}) = 1 V I _{OUT} = 0 mA	—	41	—	μs
	TCK423G		V _{IN} = 12 to 15 V, V _{IN} rising = 2 V/μs V _{GS} typ to V _{GS} (V _{GATE2} -V _{IN}) = 1 V I _{OUT} = 0 mA	—	16	—	μs
	TCK424G		V _{IN} = 9 to 12 V, V _{IN} rising = 2 V/μs V _{GS} typ to V _{GS} (V _{GATE2} -V _{IN}) = 1 V I _{OUT} = 0 mA	—	18	—	μs
	TCK425G		V _{IN} = 5 to 8 V, V _{IN} rising = 2 V/μs V _{GS} typ to V _{GS} (V _{GATE2} -V _{IN}) = 1 V I _{OUT} = 0 mA	—	19	—	μs

Note 5: C_{GATE1} and C_{GATE2} are input capacitance connected to each VGATE1 and VGATE2 instead of external MOSFET

11.7. Timing Chart

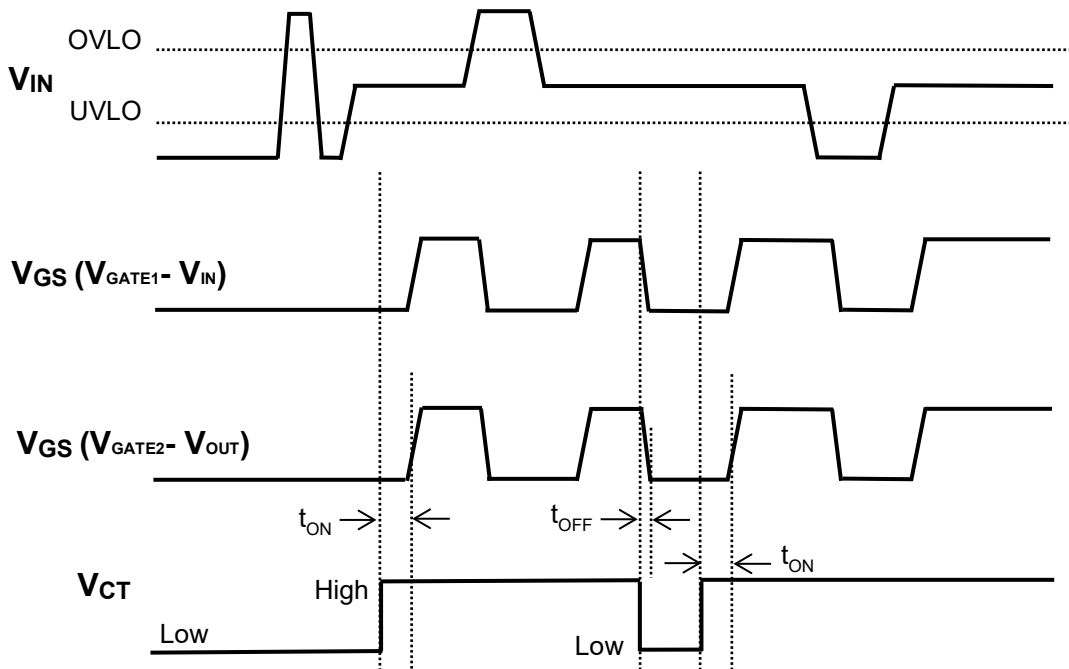

Fig.1 t_{ON}, t_{OFF}

11.8. Switching Waveform and Test circuit

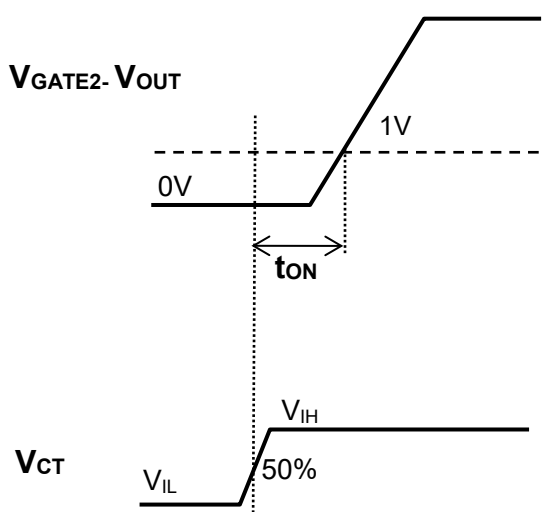

Fig.2 V_{GS} ON time Waveform

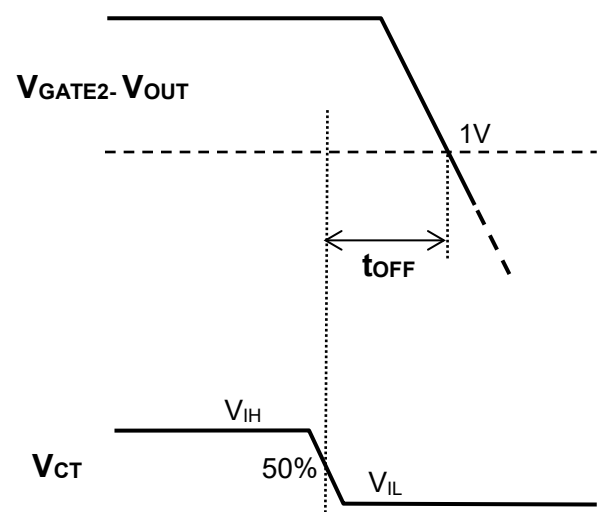

Fig.3 V_{GS} OFF time Waveform

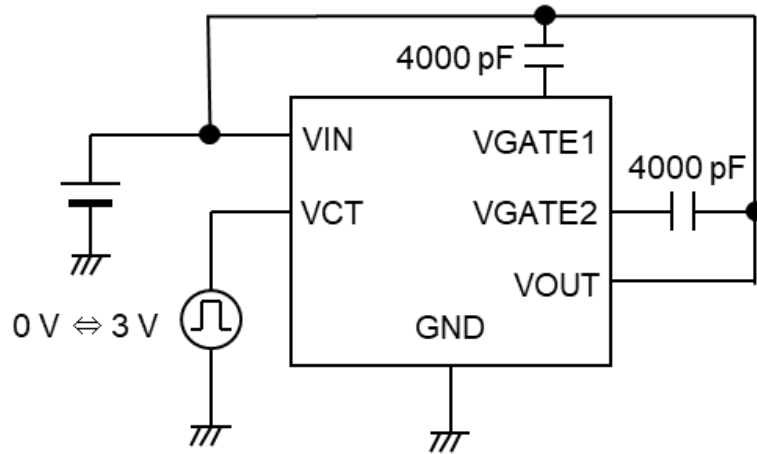

Fig.4 V_{GS} ON and OFF time test circuit

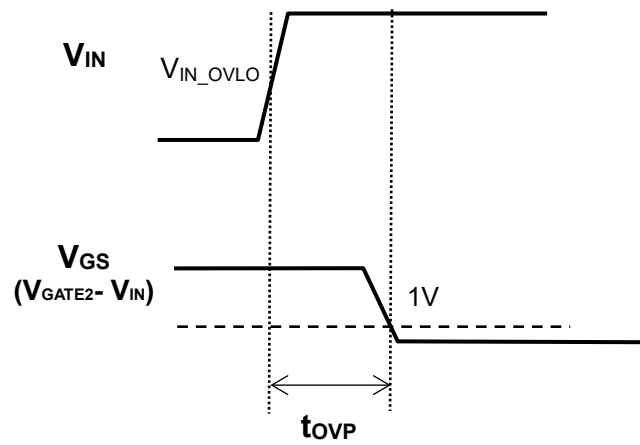

Fig.5 toVP Waveform

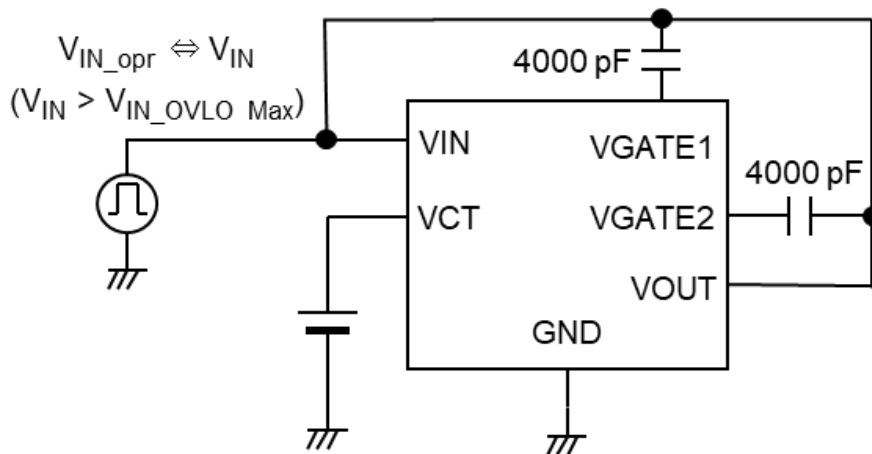
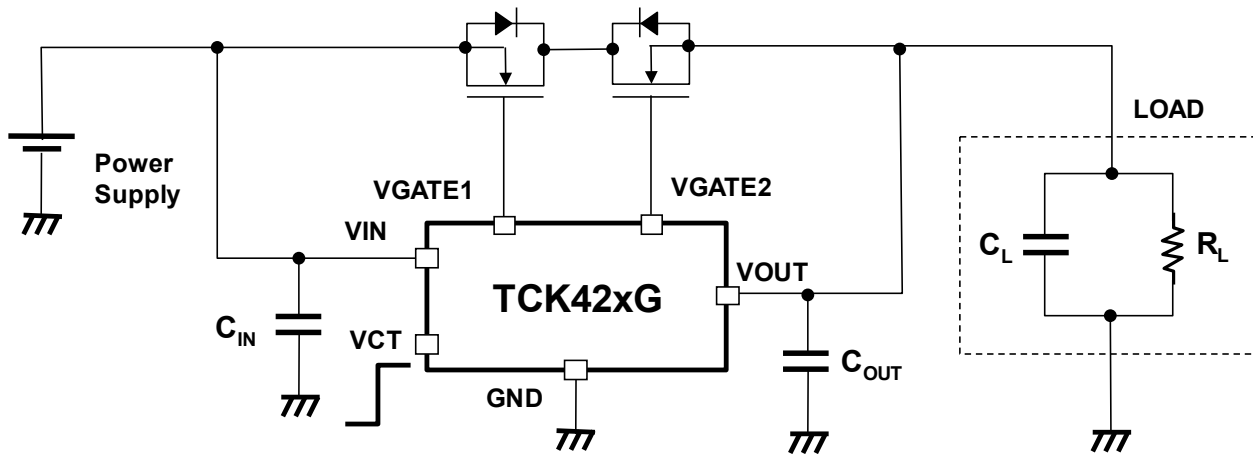

Fig.6 toVP test circuit

12. Application Note

12.1. Common Drain Connection N-channel MOSFET circuit example



1. Input and Output capacitor
An input capacitor (C_{IN}) and an output capacitor (C_{OUT}) are recommended for the stable operation. And it is effective to reduce voltage overshoot or undershoot due to sharp changes in output current and also for improved stability of the power supply. When used, place C_{IN} and C_{OUT} as close to V_{IN} pin and V_{OUT} pin to improve stability of the power supply.
2. VCT pin
VCT pin is pull down connection to GND. VCT High level voltage must be under 5.5V V_{IH} max.
3. VGATE1,2 pin and VOUT pin
VGATE1 pin is connected to Gate of V_{IN} side MOSFET. VGATE2 pin is connected to Gate of V_{OUT} side MOSFET. V_{OUT} pin is connected to Source of V_{OUT} side MOSFET. When the gate driver IC turns off state, VGATE1 terminal voltage is close to V_{IN} voltage dropped by parasitic diode forward voltage. This circuit works to protect over voltage for V_{IN} side MOSFET Gate-Source terminal. V_{OUT} terminal works to protect V_{OUT} side MOSFET as same circuit.
4. Turn on recovery time after Over Voltage Lock Out (OVLO)
Once V_{IN} is in normal voltage range after OVLO, the turn on recovery time is similar V_{GS} ON time (t_{ON}).
5. Under Voltage Lock Out (UVLO) and Over Voltage Lock Out (OVLO)
UVLO and OVLO are designed in these products, but these are not designed to constantly ensure the suppression of the gate driver IC and external MOSFETs within operation limits. Depending on the condition during actual usage, it could affect the electrical characteristic specification and reliability. To select external MOSFETs, please consider enough electrical design margin. When using these products, please read through and understand the concept of dissipation for absolute maximum ratings from the above mention or our 'Semiconductor Reliability Handbook'. Then use these products under absolute maximum ratings in any condition. Furthermore, Toshiba recommends inserting failsafe system into the design.

Common Drain Connection N-channel MOSFET Switching Waveform

Typical switching waveforms with TOSHIBA MOSFETs

OVP Gate Driver IC	MOSFET		Test conditions	
	Part Number	Description	Turn ON and OFF	Over Voltage Lock Out
TCK423G ($V_{GS} = 5.6\text{ V}$)	TPN1R603PL	Single N-channel MOSFET $V_{DSS}: 30\text{ V}$, $V_{GSS}: \pm 20\text{ V}$ $R_{DS(ON)}: 1.2\text{ m}\Omega$ typ at $V_{GS} = 10\text{ V}$ Package: TSON Advance	$V_{IN} = 12\text{ V}$ (TCK423G) $V_{IN} = 20\text{ V}$ (TCK421G) $I_{OUT} = 1\text{ A}, 3\text{ A}$ $C_{IN} = 1\text{ }\mu\text{F}$ $C_{OUT} = 1\text{ }\mu\text{F}$ $V_{CT} = 0\text{ V} \Leftrightarrow 1.2\text{ V}$ $T_a = 25\text{ }^\circ\text{C}$	$V_{IN} = 12\text{ V} \Leftrightarrow 15\text{ V}$ (TCK423G) $V_{IN} = 20\text{ V} \Leftrightarrow 25\text{ V}$ (TCK421G) $I_{OUT} = 1\text{ A}$ $C_{IN} = 1\text{ }\mu\text{F}$ $C_{OUT} = 1\text{ }\mu\text{F}$ $V_{CT} = 1.2\text{ V}$ $T_a = 25\text{ }^\circ\text{C}$
TCK421G ($V_{GS} = 10\text{ V}$)	TPHR6503PL1	Single N-channel MOSFET $V_{DSS}: 30\text{ V}$, $V_{GSS}: \pm 20\text{ V}$ $R_{DS(ON)}: 0.41\text{ m}\Omega$ typ at $V_{GS} = 10\text{ V}$ Package: SOP Advance(N)		

TCK423G + TPN1R603PL x 2pcs

1. Turn ON and OFF ($I_{OUT} = 1\text{ A}$)

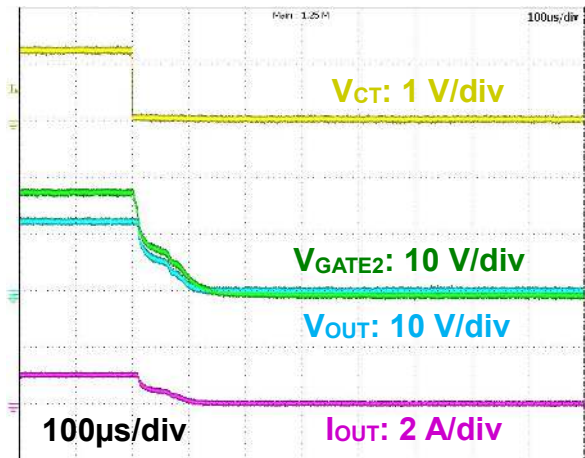
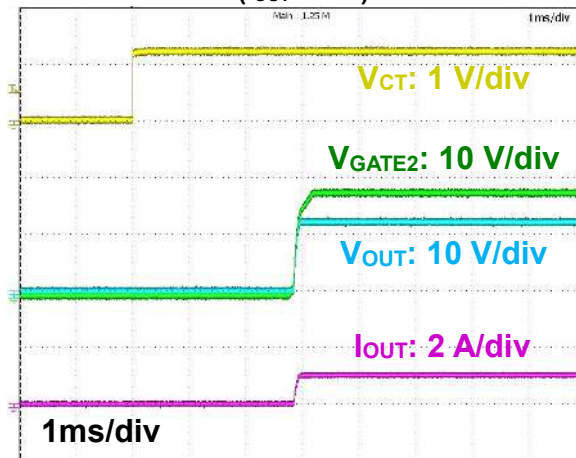

2. Turn ON and OFF ($I_{OUT} = 3\text{ A}$)

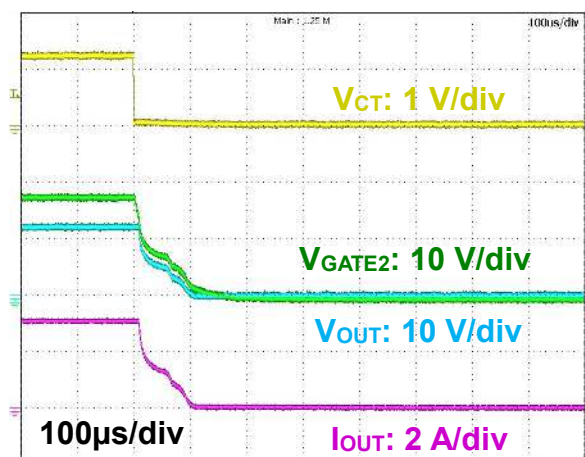
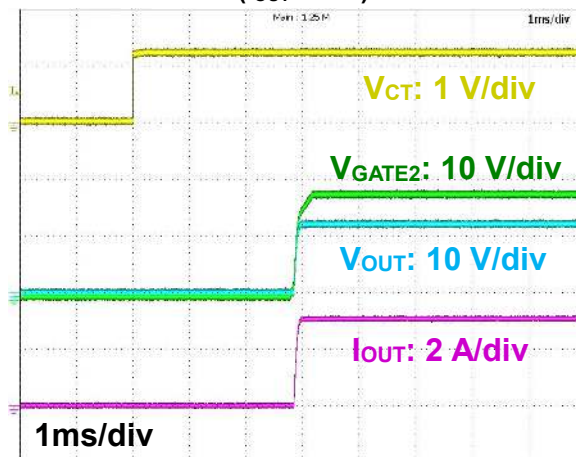

3. Over Voltage Lock Out

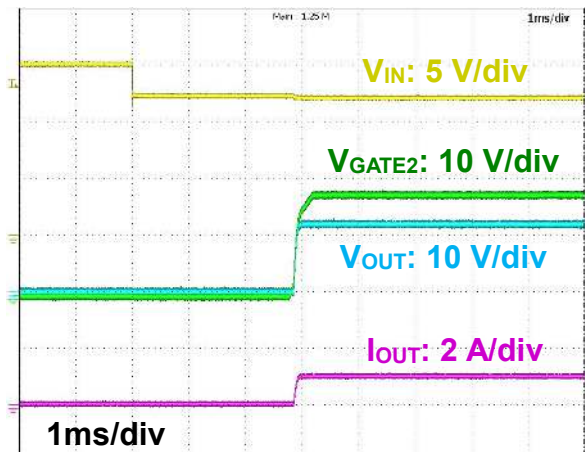
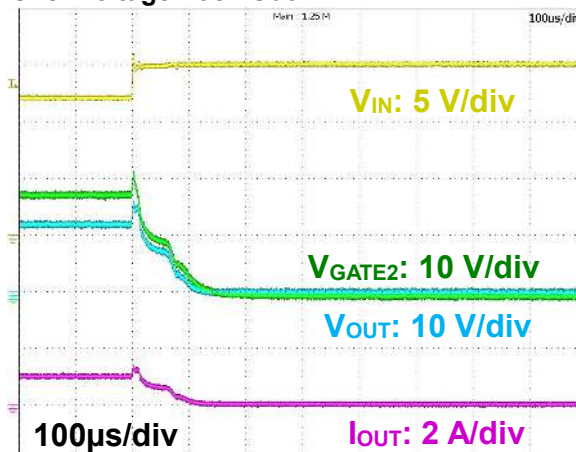

TCK421G + TPHR6503PL1 x 2pcs

1. Turn ON and OFF ($I_{OUT} = 1\text{ A}$)

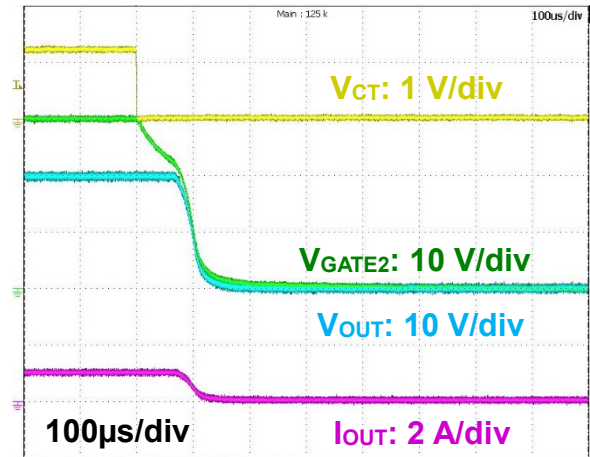
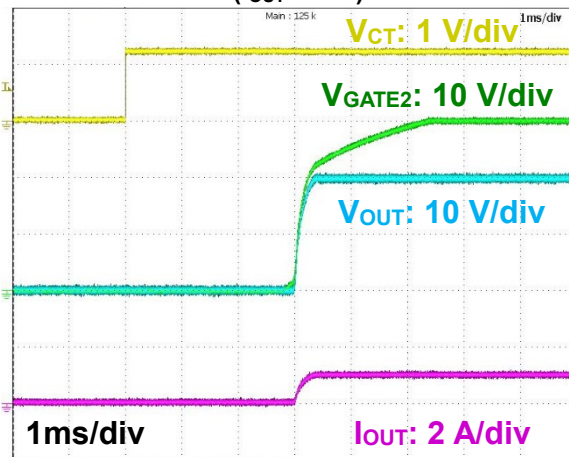

2. Turn ON and OFF ($I_{OUT} = 3\text{ A}$)

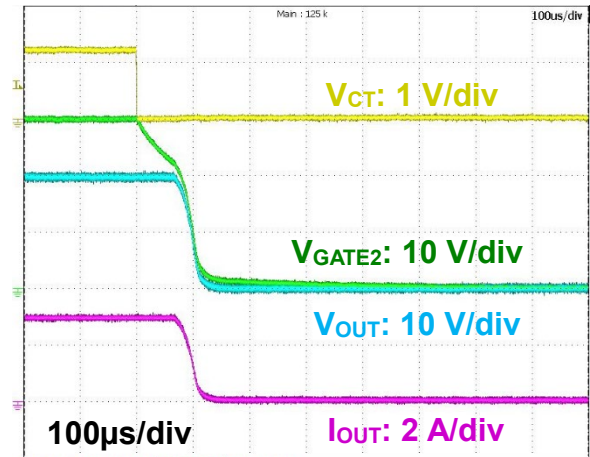
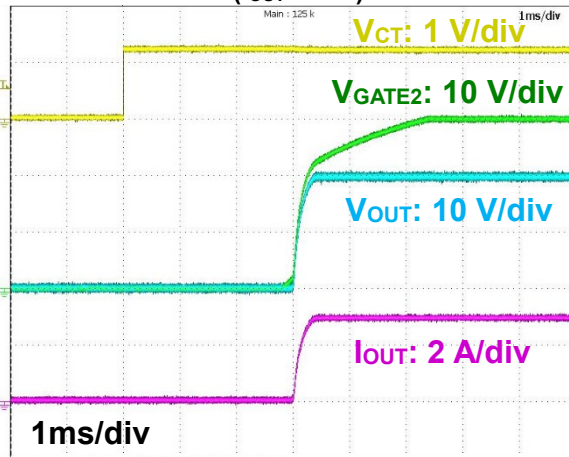

3. Over Voltage Lock Out

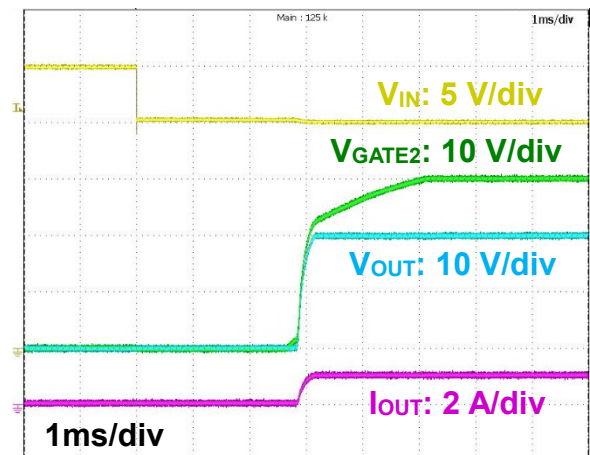
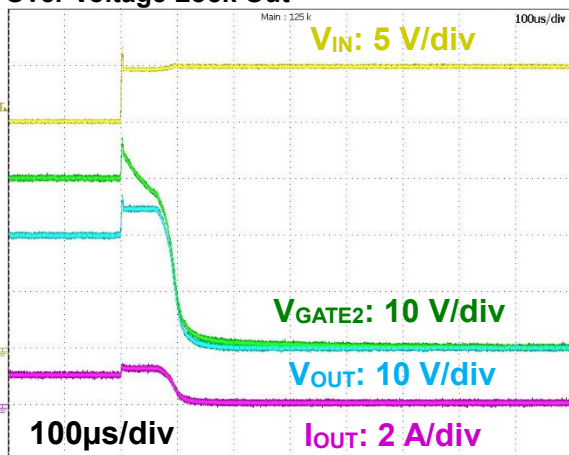

12.2. Single N-channel MOSFET circuit example

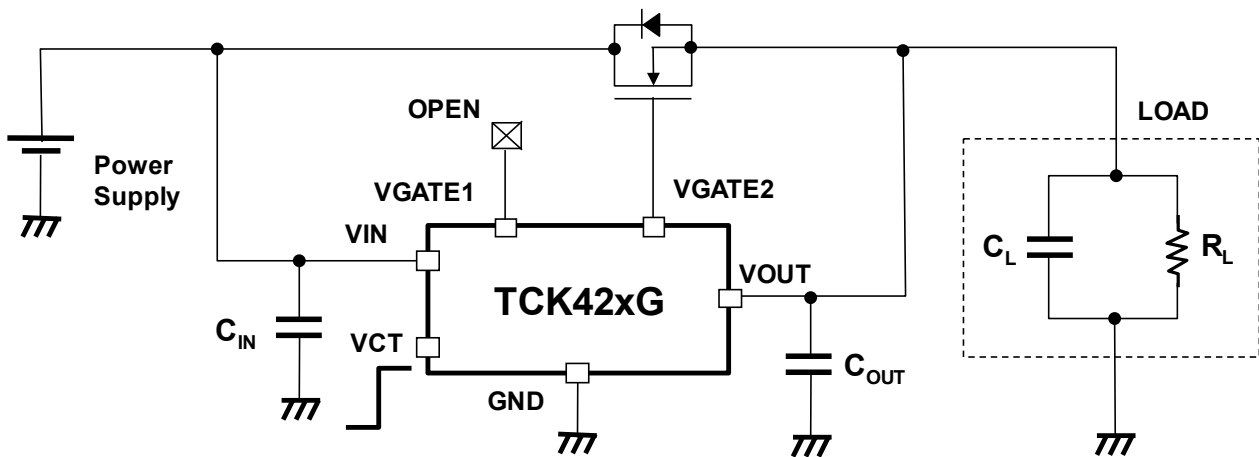

- Input and Output capacitor**
 An input capacitor (C_{IN}) and an output capacitor (C_{OUT}) are recommended for the stable operation. And it is effective to reduce voltage overshoot or undershoot due to sharp changes in output current and also for improved stability of the power supply. When used, place C_{IN} and C_{OUT} as close to V_{IN} pin and V_{OUT} pin to improve stability of the power supply.
- VCT pin**
 VCT pin is pull down connection to GND. VCT High level voltage must be under 5.5V V_{IH} max.
- VGATE1,2 pin and VOUT pin**
 VGATE1 pin is OPEN state/Non connection. VGATE2 pin is connected to Gate of MOSFET. VOUT pin is connected to Source of MOSFET. When the gate driver IC turns off state, VGATE2 terminal voltage is close to VOUT voltage dropped by parasitic diode forward voltage. This circuit works to protect over voltage for MOSFET Gate-Source terminal.
- Turn on recovery time after Over Voltage Lock Out**
 Once V_{IN} is in normal voltage range after OVLO, the turn on recovery time is similar V_{GS} ON time (t_{ON}).
- Under Voltage Lock Out (UVLO) and Over Voltage Lock Out (OVLO)**
 UVLO and OVLO are designed in these products, but these are not designed to constantly ensure the suppression of the gate driver IC and external MOSFETs within operation limits. Depending on the condition during actual usage, it could affect the electrical characteristic specification and reliability. To select external MOSFETs, please consider enough electrical design margin. When using these products, please read through and understand the concept of dissipation for absolute maximum ratings from the above mention or our 'Semiconductor Reliability Handbook'. Then use these products under absolute maximum ratings in any condition. Furthermore, Toshiba recommends inserting failsafe system into the design.

Single N-channel MOSFET Switching Waveform

Typical switching waveforms with TOSHIBA MOSFETs

OVP Gate Driver IC	MOSFET		Test conditions	
	Part Number	Description	Turn ON and OFF	Over Voltage Lock Out
TCK423G ($V_{GS} = 5.6\text{ V}$)	TPN1R603PL	Single N-channel MOSFET V_{DS} : 30 V, V_{GS} : $\pm 20\text{ V}$ $R_{DS(ON)}$: 1.2 m Ω typ at $V_{GS} = 10\text{ V}$ Package: TSON Advance	$V_{IN} = 12\text{ V}$ (TCK423G) $V_{IN} = 20\text{ V}$ (TCK421G) $I_{OUT} = 1\text{ A}, 3\text{ A}$ $C_{IN} = 1\text{ }\mu\text{F}$ $C_{OUT} = 1\text{ }\mu\text{F}$ $V_{CT} = 0\text{ V} \Leftrightarrow 1.2\text{ V}$ $T_a = 25\text{ }^\circ\text{C}$	$V_{IN} = 12\text{ V} \Leftrightarrow 15\text{ V}$ (TCK423G) $V_{IN} = 20\text{ V} \Leftrightarrow 25\text{ V}$ (TCK421G) $I_{OUT} = 1\text{ A}$ $C_{IN} = 1\text{ }\mu\text{F}$ $C_{OUT} = 1\text{ }\mu\text{F}$ $V_{CT} = 1.2\text{ V}$ $T_a = 25\text{ }^\circ\text{C}$
TCK421G ($V_{GS} = 10\text{ V}$)	TPHR6503PL1	Single N-channel MOSFET V_{DS} : 30 V, V_{GS} : $\pm 20\text{ V}$ $R_{DS(ON)}$: 0.41 m Ω typ at $V_{GS} = 10\text{ V}$ Package: SOP Advance(N)		

TCK423G + TPN1R603L

1. Turn ON and OFF ($I_{OUT} = 1\text{ A}$)

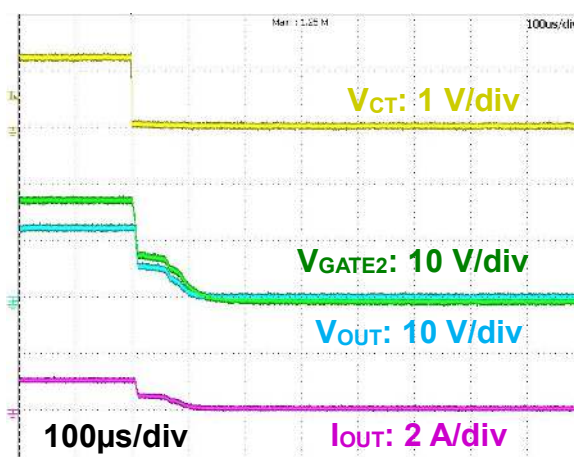
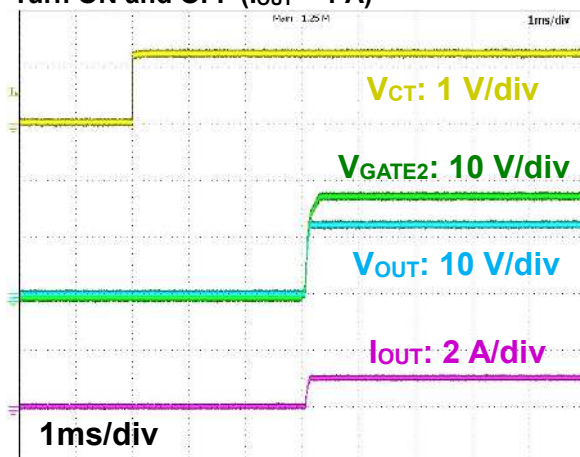

2. Turn ON and OFF ($I_{OUT} = 3\text{ A}$)

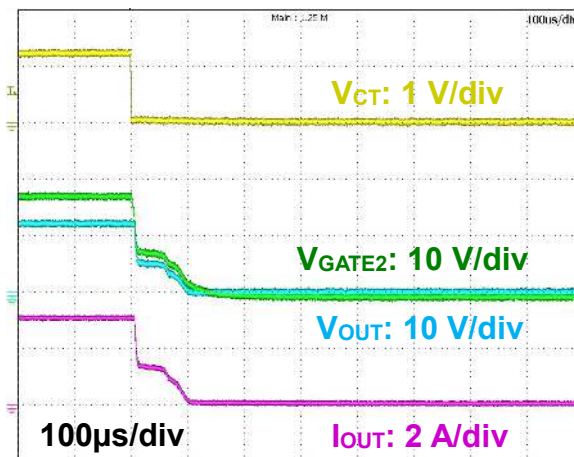
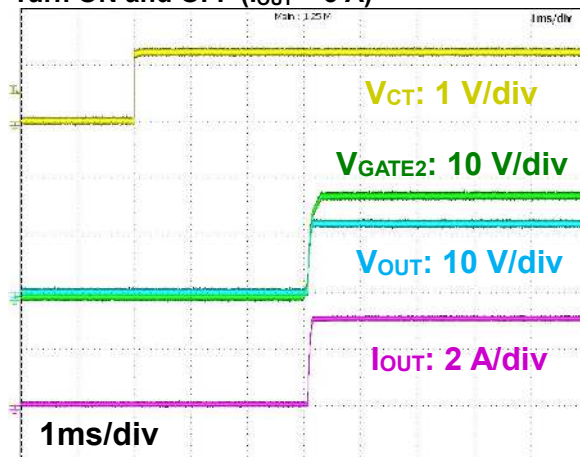

3. Over Voltage Lock Out

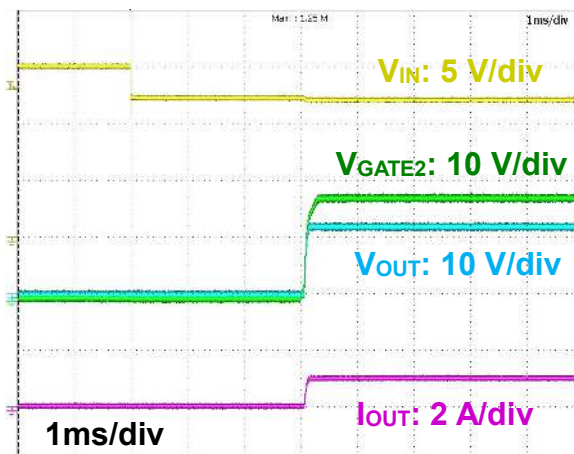
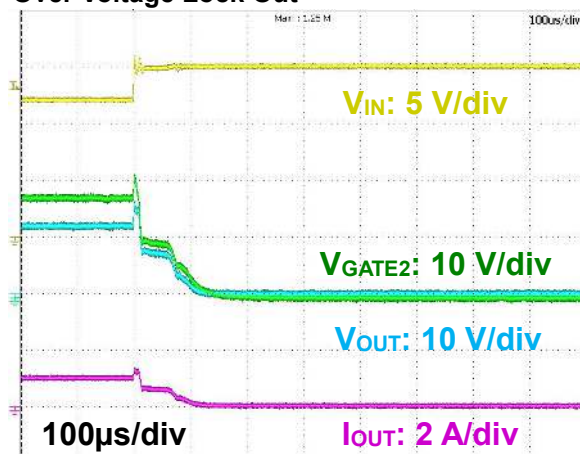

TCK421G + TPHP6503PL1

6. Turn ON and OFF ($I_{OUT} = 1\text{ A}$)

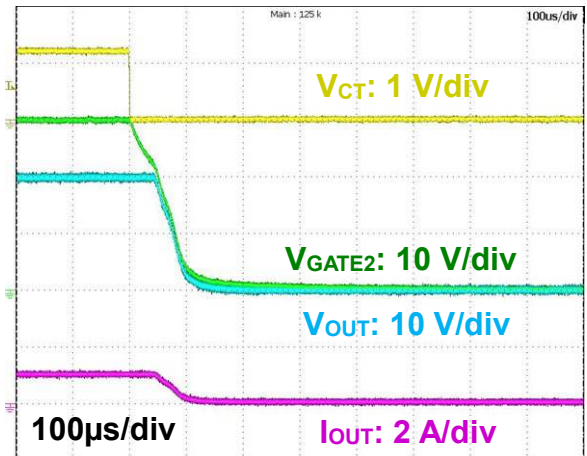
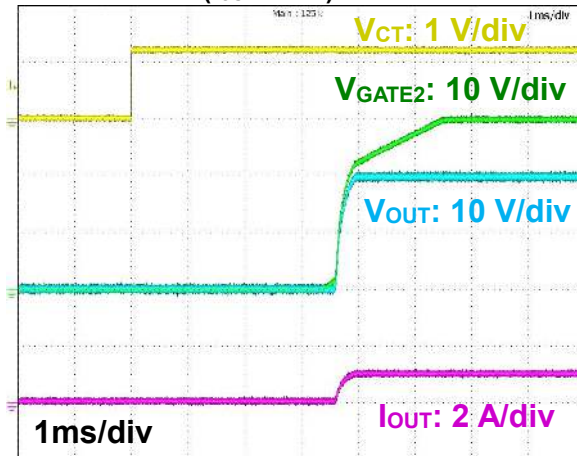

7. Turn ON and OFF ($I_{OUT} = 3\text{ A}$)

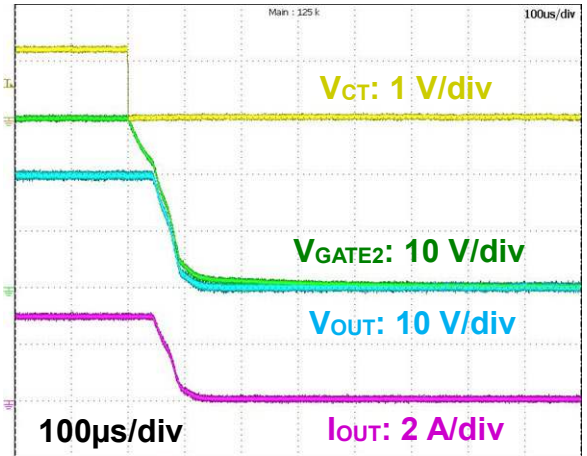
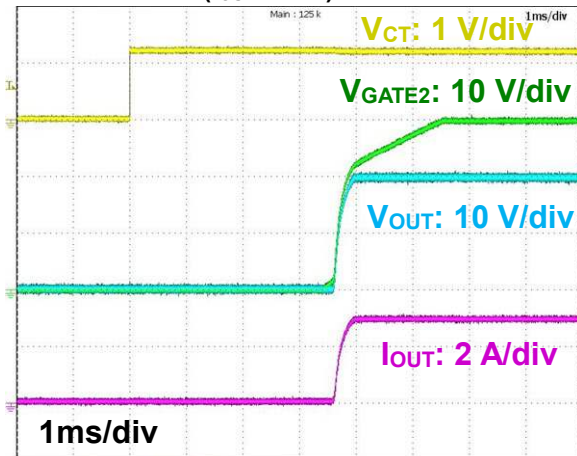

8. Over Voltage Lock Out

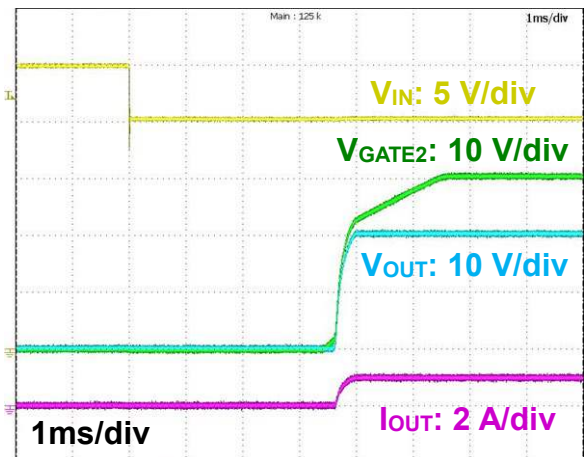
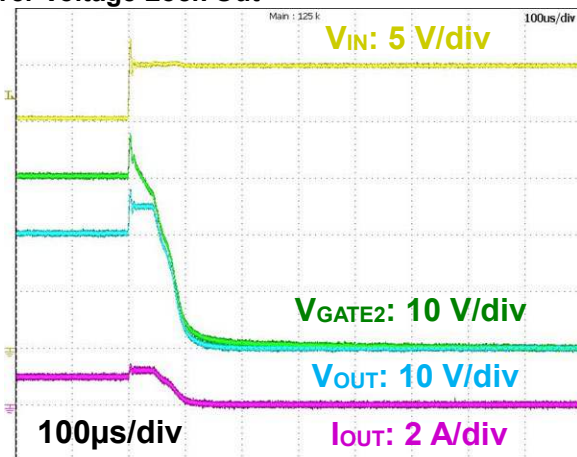

13. Representative Typical Characteristics

13.1. Gate voltage vs. Input voltage

$V_{GS} = 10\text{ V}$ (TCK421G)

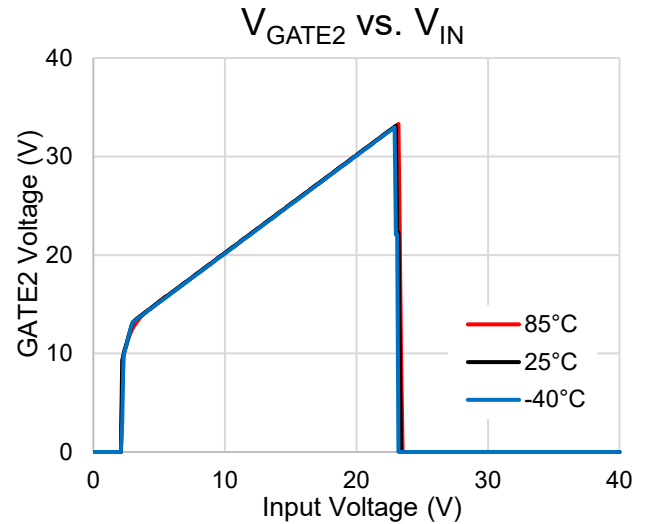
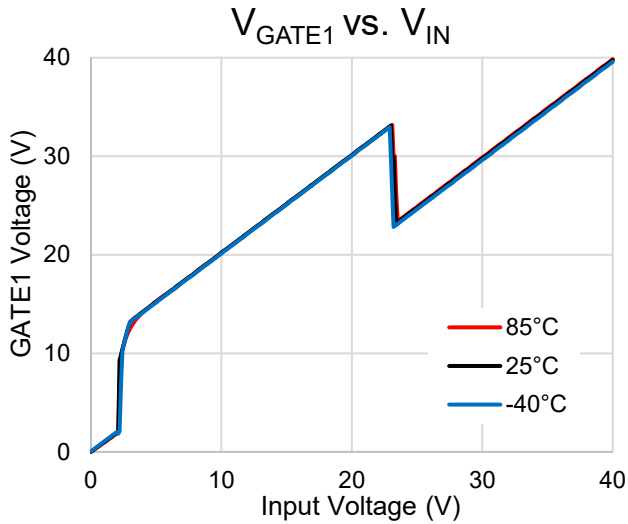

$V_{GS} = 5.6\text{ V}$ (TCK423G)

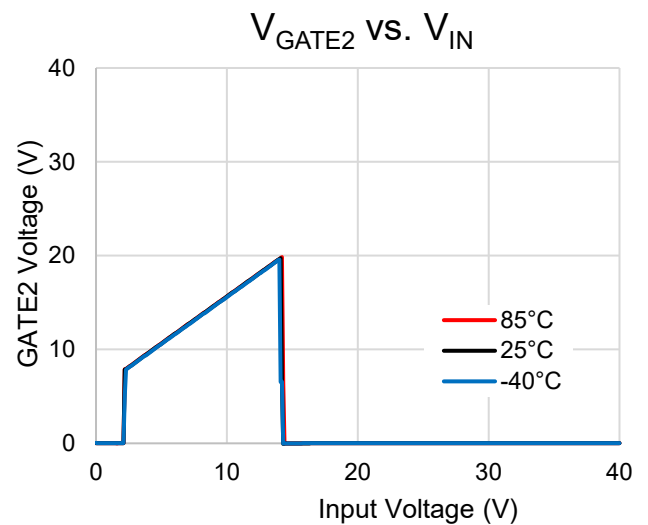
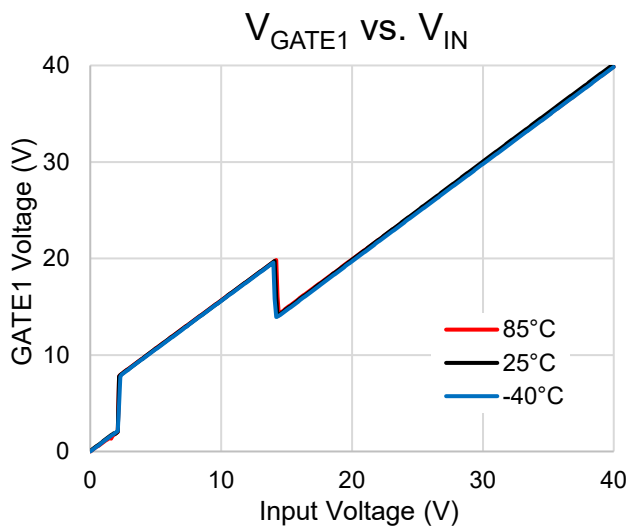

13.2. Gate voltage vs. Gate current

1. $V_{GS} = 10V$ (TCK421G)

$V_{IN} = 20V$

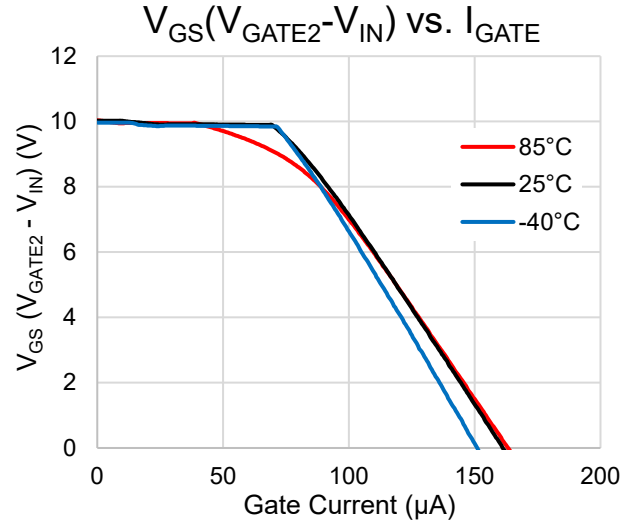
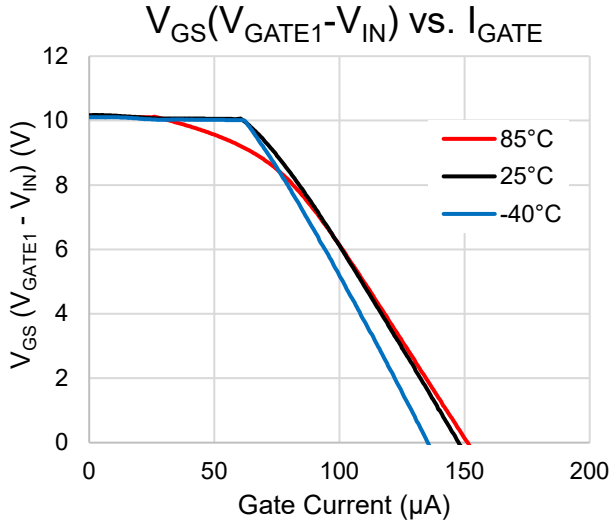

$V_{IN} = 12V$

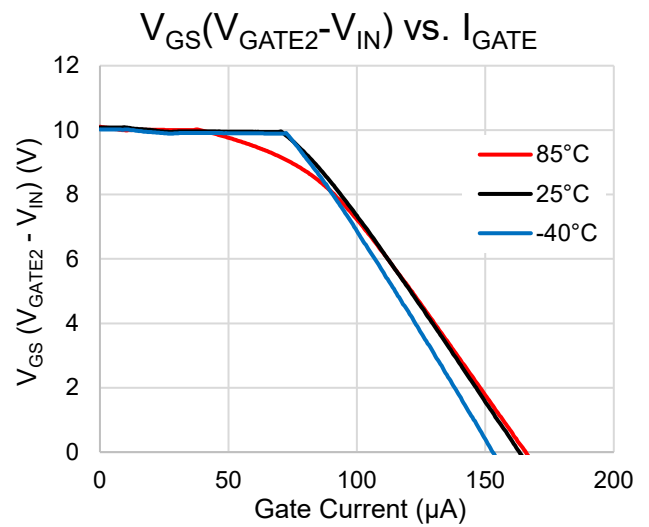
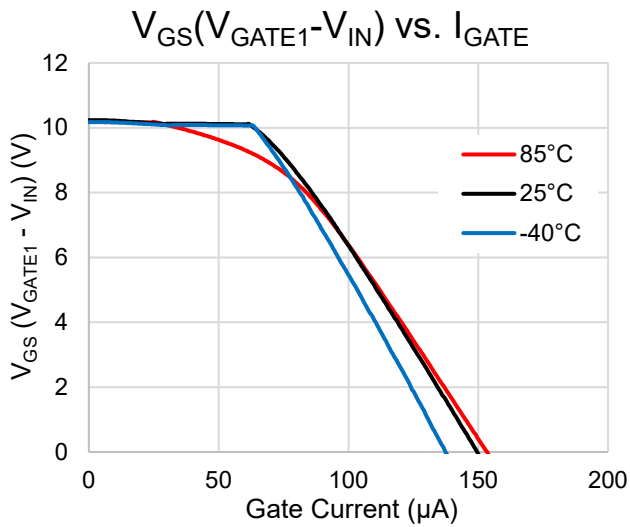

2. $V_{GS} = 5.6\text{ V}$ (TCK423G)

$V_{IN} = 12\text{ V}$

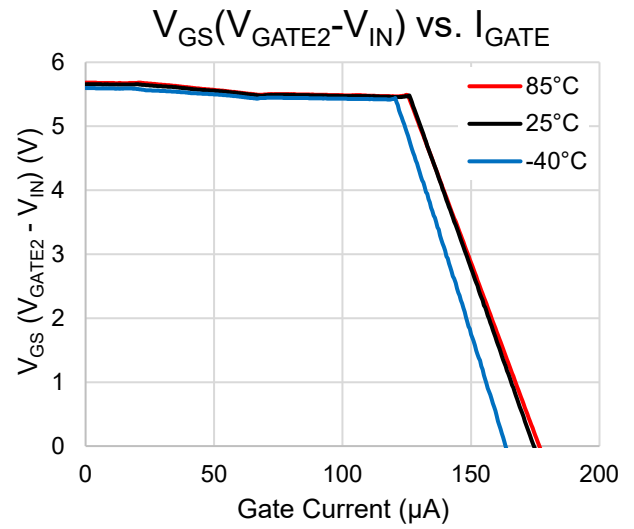
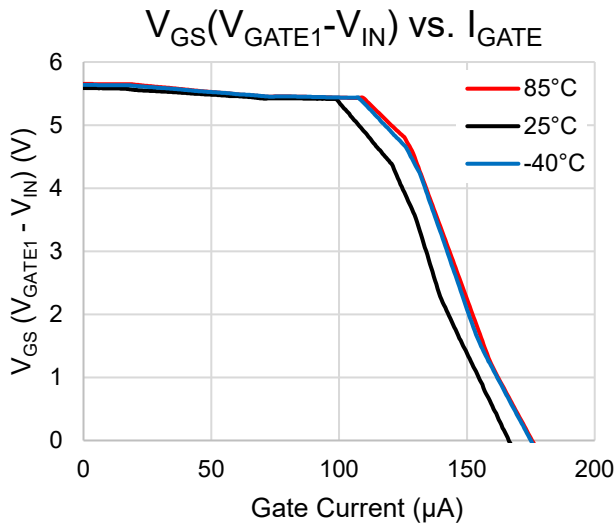

$V_{IN} = 9\text{ V}$

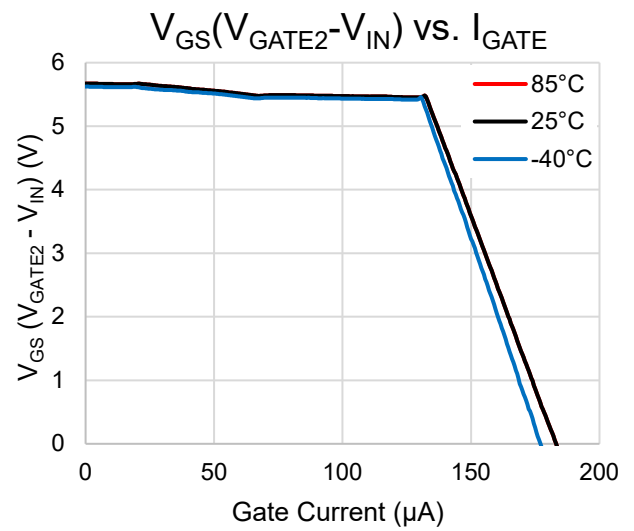
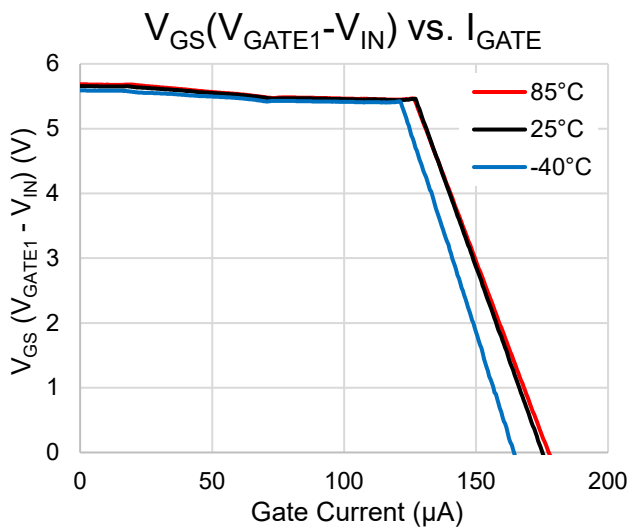

13.3. Quiescent current vs. Input voltage

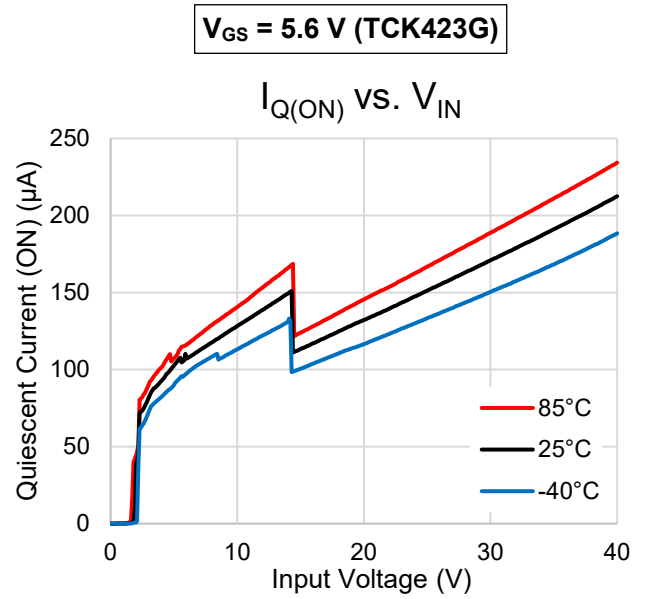
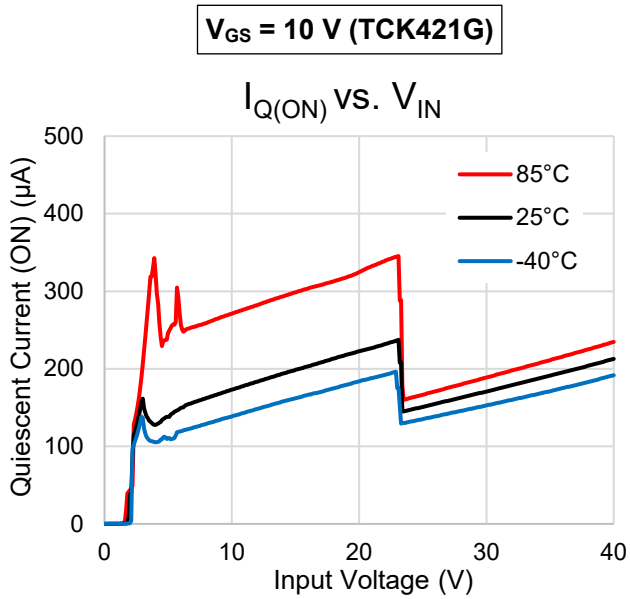

13.4. Standby current vs. Input voltage (Note 6)

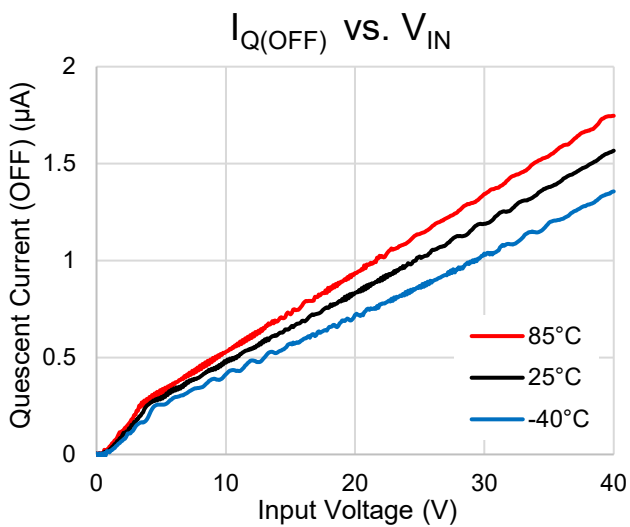

Note 6: Common characteristic of $V_{GS} = 10\text{ V}$ and 5.6 V

14. Package Information

WCSP6G

Unit: mm

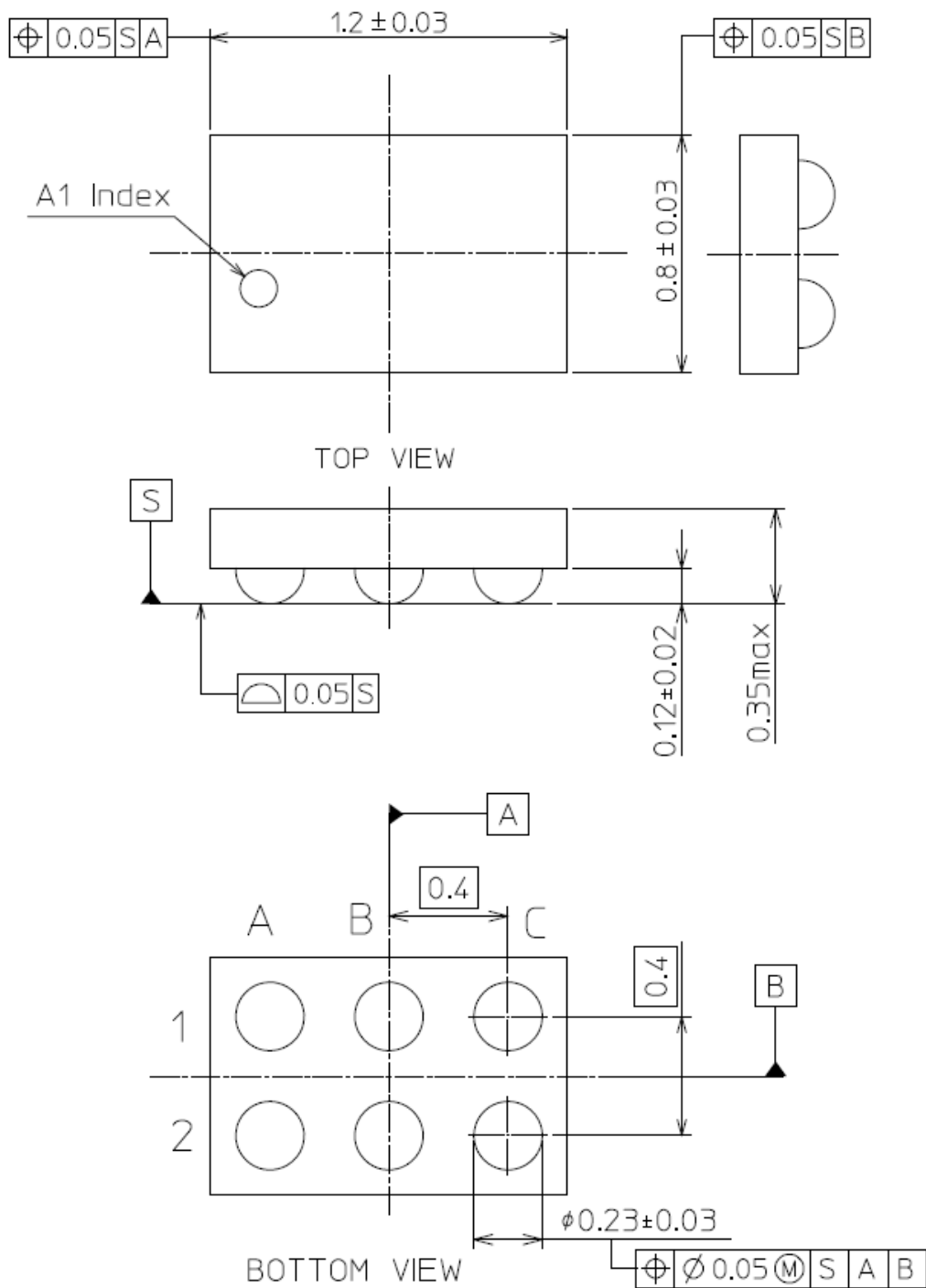

Weight: 0.61 mg (Typ.)

15. Land pattern dimensions for reference only

WCSP6G

Unit: mm

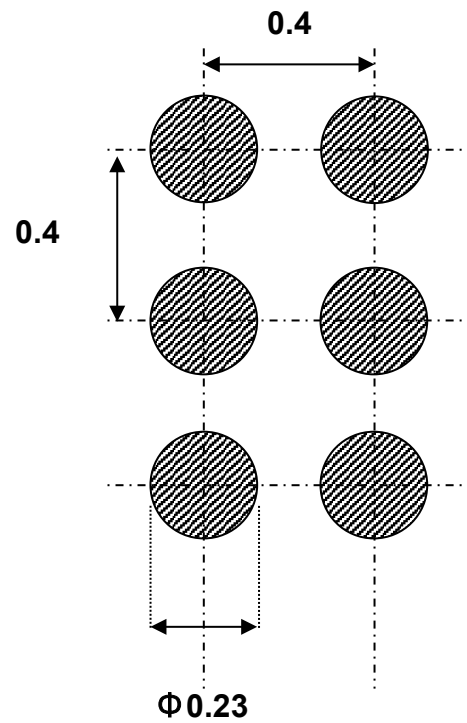

RESTRICTIONS ON PRODUCT USE

Toshiba Corporation and its subsidiaries and affiliates are collectively referred to as "TOSHIBA". Hardware, software and systems described in this document are collectively referred to as "Product".

- TOSHIBA reserves the right to make changes to the information in this document and related Product without notice.
- This document and any information herein may not be reproduced without prior written permission from TOSHIBA. Even with TOSHIBA's written permission, reproduction is permissible only if reproduction is without alteration/omission.
- Though TOSHIBA works continually to improve Product's quality and reliability, Product can malfunction or fail. Customers are responsible for complying with safety standards and for providing adequate designs and safeguards for their hardware, software and systems which minimize risk and avoid situations in which a malfunction or failure of Product could cause loss of human life, bodily injury or damage to property, including data loss or corruption. Before customers use the Product, create designs including the Product, or incorporate the Product into their own applications, customers must also refer to and comply with (a) the latest versions of all relevant TOSHIBA information, including without limitation, this document, the specifications, the data sheets and application notes for Product and the precautions and conditions set forth in the "TOSHIBA Semiconductor Reliability Handbook" and (b) the instructions for the application with which the Product will be used with or for. Customers are solely responsible for all aspects of their own product design or applications, including but not limited to (a) determining the appropriateness of the use of this Product in such design or applications; (b) evaluating and determining the applicability of any information contained in this document, or in charts, diagrams, programs, algorithms, sample application circuits, or any other referenced documents; and (c) validating all operating parameters for such designs and applications. **TOSHIBA ASSUMES NO LIABILITY FOR CUSTOMERS' PRODUCT DESIGN OR APPLICATIONS.**
- **PRODUCT IS NEITHER INTENDED NOR WARRANTED FOR USE IN EQUIPMENTS OR SYSTEMS THAT REQUIRE EXTRAORDINARILY HIGH LEVELS OF QUALITY AND/OR RELIABILITY, AND/OR A MALFUNCTION OR FAILURE OF WHICH MAY CAUSE LOSS OF HUMAN LIFE, BODILY INJURY, SERIOUS PROPERTY DAMAGE AND/OR SERIOUS PUBLIC IMPACT ("UNINTENDED USE").** Except for specific applications as expressly stated in this document, Unintended Use includes, without limitation, equipment used in nuclear facilities, equipment used in the aerospace industry, lifesaving and/or life supporting medical equipment, equipment used for automobiles, trains, ships and other transportation, traffic signaling equipment, equipment used to control combustions or explosions, safety devices, elevators and escalators, and devices related to power plant. **IF YOU USE PRODUCT FOR UNINTENDED USE, TOSHIBA ASSUMES NO LIABILITY FOR PRODUCT.** For details, please contact your TOSHIBA sales representative or contact us via our website.
- Do not disassemble, analyze, reverse-engineer, alter, modify, translate or copy Product, whether in whole or in part.
- Product shall not be used for or incorporated into any products or systems whose manufacture, use, or sale is prohibited under any applicable laws or regulations.
- The information contained herein is presented only as guidance for Product use. No responsibility is assumed by TOSHIBA for any infringement of patents or any other intellectual property rights of third parties that may result from the use of Product. No license to any intellectual property right is granted by this document, whether express or implied, by estoppel or otherwise.
- **ABSENT A WRITTEN SIGNED AGREEMENT, EXCEPT AS PROVIDED IN THE RELEVANT TERMS AND CONDITIONS OF SALE FOR PRODUCT, AND TO THE MAXIMUM EXTENT ALLOWABLE BY LAW, TOSHIBA (1) ASSUMES NO LIABILITY WHATSOEVER, INCLUDING WITHOUT LIMITATION, INDIRECT, CONSEQUENTIAL, SPECIAL, OR INCIDENTAL DAMAGES OR LOSS, INCLUDING WITHOUT LIMITATION, LOSS OF PROFITS, LOSS OF OPPORTUNITIES, BUSINESS INTERRUPTION AND LOSS OF DATA, AND (2) DISCLAIMS ANY AND ALL EXPRESS OR IMPLIED WARRANTIES AND CONDITIONS RELATED TO SALE, USE OF PRODUCT, OR INFORMATION, INCLUDING WARRANTIES OR CONDITIONS OF MERCHANTABILITY, FITNESS FOR A PARTICULAR PURPOSE, ACCURACY OF INFORMATION, OR NONINFRINGEMENT.**
- Do not use or otherwise make available Product or related software or technology for any military purposes, including without limitation, for the design, development, use, stockpiling or manufacturing of nuclear, chemical, or biological weapons or missile technology products (mass destruction weapons). Product and related software and technology may be controlled under the applicable export laws and regulations including, without limitation, the Japanese Foreign Exchange and Foreign Trade Law and the U.S. Export Administration Regulations. Export and re-export of Product or related software or technology are strictly prohibited except in compliance with all applicable export laws and regulations.
- Please contact your TOSHIBA sales representative for details as to environmental matters such as the RoHS compatibility of Product. Please use Product in compliance with all applicable laws and regulations that regulate the inclusion or use of controlled substances, including without limitation, the EU RoHS Directive. **TOSHIBA ASSUMES NO LIABILITY FOR DAMAGES OR LOSSES OCCURRING AS A RESULT OF NONCOMPLIANCE WITH APPLICABLE LAWS AND REGULATIONS.**