

MDE Semiconductor, Inc.

201 Shipyard Way, Unit C, Newport Beach, CA., USA 92663 Tel : 760-564-8656 • Fax : 760-564-2414
1-800-831-4881 Email: sales@mdesemiconductor.com Web: www.mdesemiconductor.com

5.0 SMDJ SERIES

SURFACE MOUNT TRANSIENT VOLTAGE SUPPRESSOR VOLTAGE-5.0 TO 170 Volts 5000 Watt Peak Pulse Power

FEATURES

- For surface mounted applications in order to optimize board space
- Low profile package
- Built-in strain relief
- Glass passivated junction
- Low inductance
- Excellent clamping capability
- Repetition rate (duty cycle):0.01%
- Fast response time: typically less than 1.0 ps from 0 volts to BV for unidirectional types
- Typical IR less than 1μA above 10V
- High temperature soldering:
250°C/10 seconds at terminals
- Plastic package has Underwriters Laboratory Flammability Classification 94 V-0

DO-214AB (SMC J-Bend)

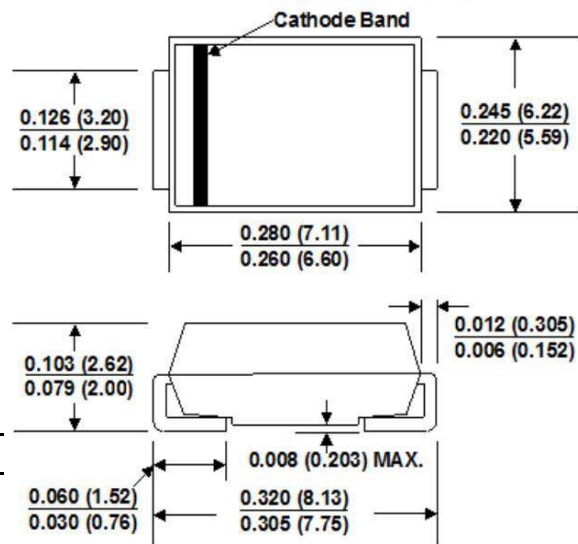

Dimensions in inches and (millimeters)

MECHANICAL DATA

Case: JEDEC DO214AB. Molded plastic over glass passivated junction
Terminals: Solder plated, solderable per MIL-STD-750, Method 2026
Polarity: Color band denoted positive end (cathode) except Bidirectional
Standard Packaging: 12mm tape (EIA STD RS-481)
Weight: 0.007 ounces, 0.021 grams)

DEVICES FOR BIPOLAR APPLICATIONS

For Bidirectional use C or CA Suffix for types 5.0SMDJ5.0 thru types 5.0SMDJ170 (e.g. 5.0SMDJ5.0C, 5.0SMDJ170CA)
Electrical characteristics apply in both directions.

MAXIMUM RATINGS AND CHARACTERISTICS

Ratings at 25°C ambient temperature unless otherwise specified.

| RATING | SYMBOL | VALUE | UNITS |
|--|-----------------------------------|--------------|-------|
| Peak Pulse Power Dissipation on 10/1000 μs waveform (NOTE 1, 2, Fig.1) | P _{PPM} | Minimum 5000 | Watts |
| Peak Pulse Current of on 10/1000 μs waveform (Note 1, Fig 3) | I _{PPM} | SEE TABLE 1 | Amps |
| Peak Forward Surge Current, 8.3ms Single Half Sine-wave Superimposed on Rated Load, (JEDEC Method)(Note2, 3) | I _{FSM} | 400 | Amps |
| Operating Junction and Storage Temperature Range | T _J , T _{STG} | -55 +150 | °C |

NOTES:

1. Non-repetitive current pulse, per Fig.3 and derated above Ta=25 °C per Fig.2.
2. Mounted on 8x8mm Copper Pads to each terminal.
3. 8.3ms single half sine-wave, or equivalent square wave, Duty cycle=4 pulses per minutes maximum.

Certified RoHS Compliant

UL File # E223026

6/29/2022

MDE Semiconductor, Inc.

201 Shipyard Way, Unit C, Newport Beach, CA., USA 92663 Tel : 760-564-8656 • Fax : 760-564-2414
1-800-831-4881 Email: sales@mdesemiconductor.com Web: www.mdesemiconductor.com

5000 Watt Surface Mount TVS

| UNI-POLAR | BI-POLAR | DEVICE MARKING CODE | | REVERSE STANDOFF VOLTAGE V_{RWM} (V) | BREAKDOWN VOLTAGE V_{BR} (V) MIN. @ I_T | BREAKDOWN VOLTAGE V_{BR} (V) MAX. @ I_T | TEST CURRENT (I_T) mA | MAXIMUM CLAMPING VOLTAGE @ I_{PP} V_C (V) | PEAK PULSE CURRENT I_{PP} (A) | REVERSE LEAKAGE @ V_{RWM} I_R (μ A) |
|-------------|--------------|---------------------|------|--|---|---|---------------------------|---|---------------------------------|--|
| | | UNI | BI | | | | | | | |
| 5.0SMDJ5.0A | 5.0SMDJ5.0CA | 5RDE | 5DDE | 5.00 | 6.40 | 7.00 | 10 | 9.2 | 543.6 | 1050 |
| 5.0SMDJ6.0A | 5.0SMDJ6.0CA | 5RDG | 5DDG | 6.00 | 6.67 | 7.37 | 10 | 10.3 | 485.5 | 1050 |
| 5.0SMDJ6.5A | 5.0SMDJ6.5CA | 5RDK | 5DDK | 6.50 | 7.22 | 7.98 | 10 | 11.2 | 446.5 | 750 |
| 5.0SMDJ7.0A | 5.0SMDJ7.0CA | 5PDM | 5DDM | 7.00 | 7.78 | 8.60 | 10 | 12.0 | 416.8 | 300 |
| 5.0SMDJ7.5A | 5.0SMDJ7.5CA | 5PDP | 5DDP | 7.50 | 8.33 | 9.21 | 1 | 12.9 | 387.7 | 150 |
| 5.0SMDJ8.0A | 5.0SMDJ8.0CA | 5PDR | 5DDR | 8.00 | 8.89 | 9.83 | 1 | 13.6 | 367.7 | 70 |
| 5.0SMDJ8.5A | 5.0SMDJ8.5CA | 5PDT | 5DDT | 8.50 | 9.44 | 10.40 | 1 | 14.4 | 347.3 | 30 |
| 5.0SMDJ9.0A | 5.0SMDJ9.0CA | 5PDV | 5DDV | 9.00 | 10.00 | 11.10 | 1 | 15.4 | 324.8 | 12 |
| 5.0SMDJ10A | 5.0SMDJ10CA | 5PDX | 5DDX | 10.00 | 11.10 | 12.30 | 1 | 17.0 | 294.2 | 6 |
| 5.0SMDJ11A | 5.0SMDJ11CA | 5PDZ | 5DDZ | 11.00 | 12.20 | 13.50 | 1 | 18.2 | 274.8 | 2 |
| 5.0SMDJ12A | 5.0SMDJ12CA | 5PEP | 5BEP | 12.00 | 13.30 | 14.70 | 1 | 19.9 | 252.0 | 2 |
| 5.0SMDJ13A | 5.0SMDJ13CA | 5PEQ | 5BEQ | 13.00 | 14.40 | 15.90 | 1 | 21.5 | 233.0 | 2 |
| 5.0SMDJ14A | 5.0SMDJ14CA | 5PER | 5BER | 14.00 | 15.60 | 17.20 | 1 | 23.2 | 216.0 | 2 |
| 5.0SMDJ15A | 5.0SMDJ15CA | 5PES | 5BES | 15.00 | 16.70 | 18.50 | 1 | 24.4 | 205.0 | 2 |
| 5.0SMDJ16A | 5.0SMDJ16CA | 5PET | 5BET | 16.00 | 17.80 | 19.70 | 1 | 26.0 | 193.0 | 2 |
| 5.0SMDJ17A | 5.0SMDJ17CA | 5PEU | 5BEU | 17.00 | 18.90 | 20.90 | 1 | 27.6 | 181.0 | 2 |
| 5.0SMDJ18A | 5.0SMDJ18CA | 5PEV | 5BEV | 18.00 | 20.00 | 22.10 | 1 | 29.2 | 172.0 | 2 |
| 5.0SMDJ20A | 5.0SMDJ20CA | 5PEW | 5BEW | 20.00 | 22.20 | 24.50 | 1 | 32.4 | 155.0 | 2 |
| 5.0SMDJ22A | 5.0SMDJ22CA | 5PEX | 5BEX | 22.00 | 24.40 | 26.90 | 1 | 35.5 | 141.0 | 2 |
| 5.0SMDJ24A | 5.0SMDJ24CA | 5PEZ | 5BEZ | 24.00 | 26.70 | 29.50 | 1 | 38.9 | 129.0 | 2 |
| 5.0SMDJ26A | 5.0SMDJ26CA | 5PFE | 5BFE | 26.00 | 28.90 | 31.90 | 1 | 42.1 | 119.0 | 2 |
| 5.0SMDJ28A | 5.0SMDJ28CA | 5PFG | 5BFG | 28.00 | 31.10 | 34.40 | 1 | 45.4 | 110.0 | 2 |
| 5.0SMDJ30A | 5.0SMDJ30CA | 5PFK | 5BFK | 30.00 | 33.30 | 36.80 | 1 | 48.4 | 103.0 | 2 |
| 5.0SMDJ33A | 5.0SMDJ33CA | 5PFM | 5BFM | 33.00 | 36.70 | 40.60 | 1 | 53.3 | 93.9 | 2 |
| 5.0SMDJ36A | 5.0SMDJ36CA | 5PFP | 5BFP | 36.00 | 40.00 | 44.20 | 1 | 58.1 | 86.1 | 2 |
| 5.0SMDJ40A | 5.0SMDJ40CA | 5PFR | 5BFR | 40.00 | 44.40 | 49.10 | 1 | 64.5 | 77.6 | 2 |
| 5.0SMDJ43A | 5.0SMDJ43CA | 5PFT | 5BFT | 43.00 | 47.80 | 52.80 | 1 | 69.4 | 72.1 | 2 |
| 5.0SMDJ45A | 5.0SMDJ45CA | 5PFV | 5BFV | 45.00 | 50.00 | 55.30 | 1 | 72.7 | 68.8 | 2 |
| 5.0SMDJ48A | 5.0SMDJ48CA | 5PFX | 5BFX | 48.00 | 53.30 | 58.90 | 1 | 77.4 | 64.7 | 2 |
| 5.0SMDJ51A | 5.0SMDJ51CA | 5PFZ | 5BFZ | 51.00 | 56.70 | 62.70 | 1 | 82.4 | 60.7 | 2 |
| 5.0SMDJ54A | 5.0SMDJ54CA | 5PGE | 5BGE | 54.00 | 60.00 | 66.30 | 1 | 87.1 | 57.5 | 2 |
| 5.0SMDJ58A | 5.0SMDJ58CA | 5PGG | 5BGG | 58.00 | 64.40 | 71.20 | 1 | 93.6 | 53.5 | 2 |
| 5.0SMDJ60A | 5.0SMDJ60CA | 5PGK | 5BGK | 60.00 | 66.70 | 73.70 | 1 | 96.8 | 51.7 | 2 |
| 5.0SMDJ64A | 5.0SMDJ64CA | 5PGM | 5BGM | 64.00 | 71.10 | 78.60 | 1 | 103.0 | 48.6 | 2 |
| 5.0SMDJ70A | 5.0SMDJ70CA | 5PGP | 5BGB | 70.00 | 77.80 | 86.00 | 1 | 113.0 | 44.3 | 2 |
| 5.0SMDJ75A | 5.0SMDJ75CA | 5PGR | 5BGR | 75.00 | 83.30 | 92.10 | 1 | 121.0 | 41.4 | 2 |
| 5.0SMDJ78A | 5.0SMDJ78CA | 5PGT | 5BGT | 78.00 | 86.70 | 95.80 | 1 | 126.0 | 39.7 | 2 |
| 5.0SMDJ85A | 5.0SMDJ85CA | 5PGV | 5BGV | 85.00 | 94.40 | 104.00 | 1 | 137.0 | 36.5 | 2 |
| 5.0SMDJ90A | 5.0SMDJ90CA | 5PGX | 5BGX | 90.00 | 100.00 | 111.00 | 1 | 146.0 | 34.3 | 2 |
| 5.0SMDJ100A | 5.0SMDJ100CA | 5PGZ | 5BGZ | 100.00 | 111.00 | 123.00 | 1 | 162.0 | 30.9 | 2 |
| 5.0SMDJ110A | 5.0SMDJ110CA | 5PHE | 5BHE | 110.00 | 122.00 | 135.00 | 1 | 177.0 | 28.3 | 2 |
| 5.0SMDJ120A | 5.0SMDJ120CA | 5PHG | 5BHG | 120.00 | 133.00 | 147.00 | 1 | 193.0 | 26.0 | 2 |
| 5.0SMDJ130A | 5.0SMDJ130CA | 5PHK | 5BHK | 130.00 | 144.00 | 159.00 | 1 | 209.0 | 24.0 | 2 |
| 5.0SMDJ150A | 5.0SMDJ150CA | 5PHM | 5BHM | 150.00 | 167.00 | 185.00 | 1 | 243.0 | 20.6 | 2 |
| 5.0SMDJ160A | 5.0SMDJ160CA | 5PHP | 5BHB | 160.00 | 178.00 | 197.00 | 1 | 259.0 | 19.3 | 2 |
| 5.0SMDJ170A | 5.0SMDJ170CA | 5PHR | 5BHR | 170.00 | 189.00 | 209.00 | 1 | 275.0 | 18.2 | 2 |

For bidirectional type having V_{RWM} of 20 volts and less, the IR limit is double.

For parts without A, the VBR is $\pm 10\%$

MDE Semiconductor, Inc.

201 Shipyard Way, Unit C, Newport Beach, CA, USA 92663 Tel : 760-564-8656 • Fax : 760-564-2414
 1-800-831-4881 Email : sales@mdesemiconductor.com Web: www.mdesemiconductor.com

RATING AND CHARACTERISTIC CURVES 5.0SMDJ SERIES

Fig. 1 - Peak Pulse Power Rating

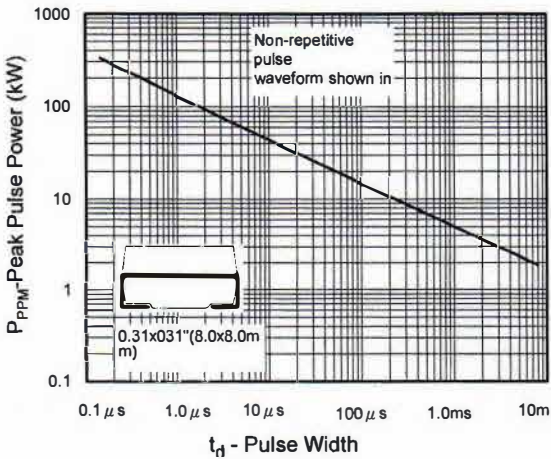

Fig.2 - Pulse Derating

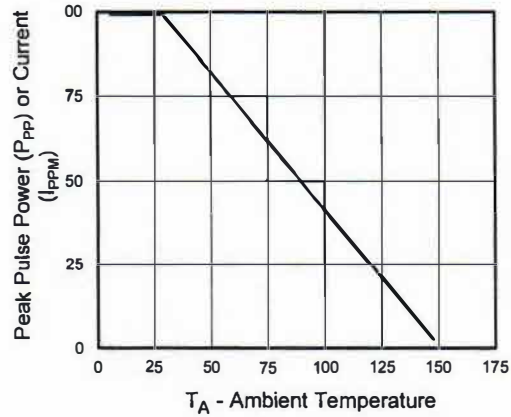

Fig. 5 - Steady State Power Derating

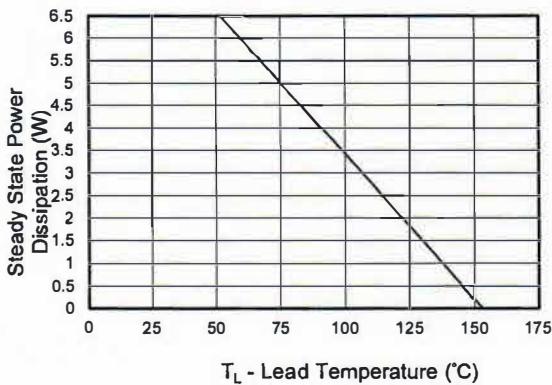

Fig.6 - Maximum Non-repetitive Forward

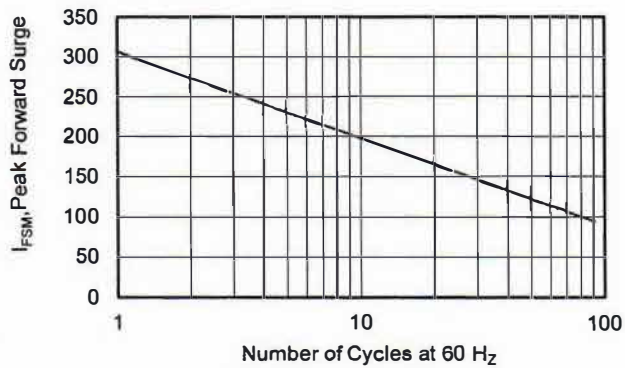

Fig.3 - Pulse Waveform

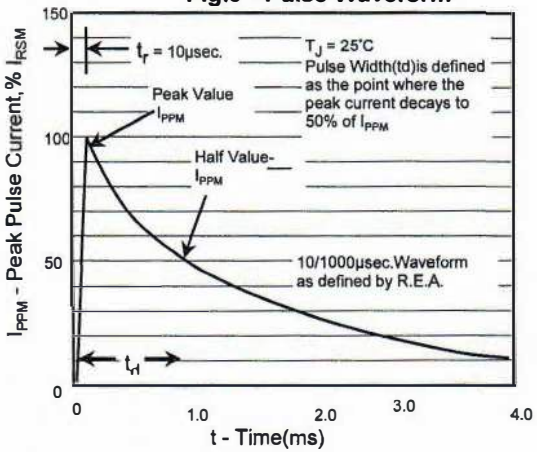
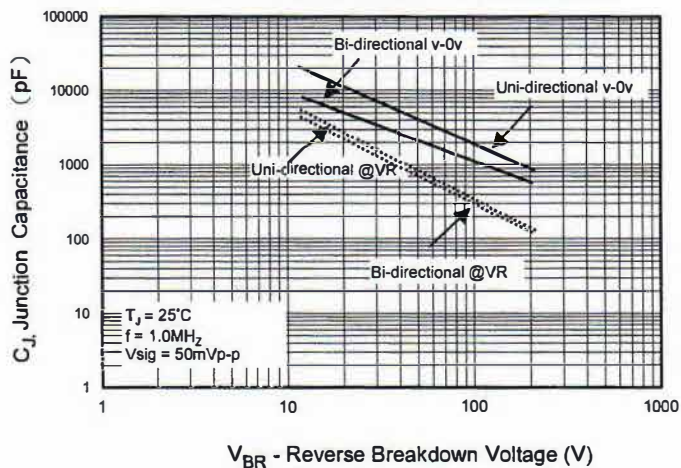

Fig. 4 - Typical Junction Capacitance



Certified RoHS Compliant
 UL File # E223026

MDE Semiconductor, Inc.

201 Shipyard Way, Unit C, Newport Beach, CA., USA 92663 Tel : 760-564-8656 • Fax : 760-564-2414
 1-800-831-4881 Email: sales@mdesemiconductor.com Web: www.mdesemiconductor.com

5.0 SMDJ SERIES

SURFACE MOUNT TRANSIENT VOLTAGE SUPPRESSOR

VOLTAGE-12.0 TO 15.0 Volts

5000 Watt Peak Pulse Power

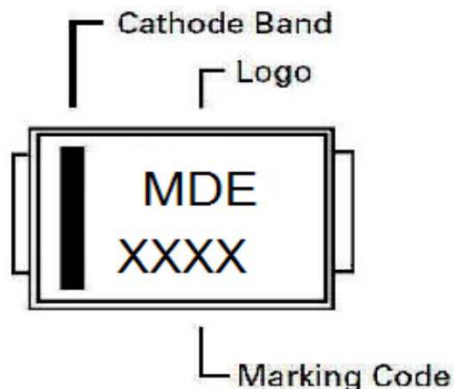
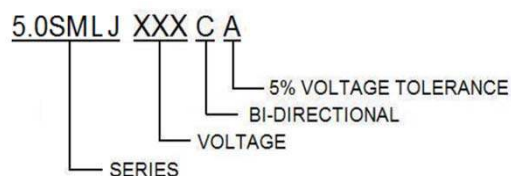

| Part number | Component Package | Quantity | Packaging Option | Packaging Specification |
|--------------|-------------------|----------|-----------------------------|-------------------------|
| 5.0SMDJxxxXX | DO-214AB | 3000 | Tape & Reel - 16mm/13" tape | EIA STD RS-481 |
| 5.0SMDJxxxXX | DO-214AB | 500 | Tape & Reel - 16mm/ 7" tape | EIA STD RS-481 |