

Supplementary Circuit Protectors Type GSB63

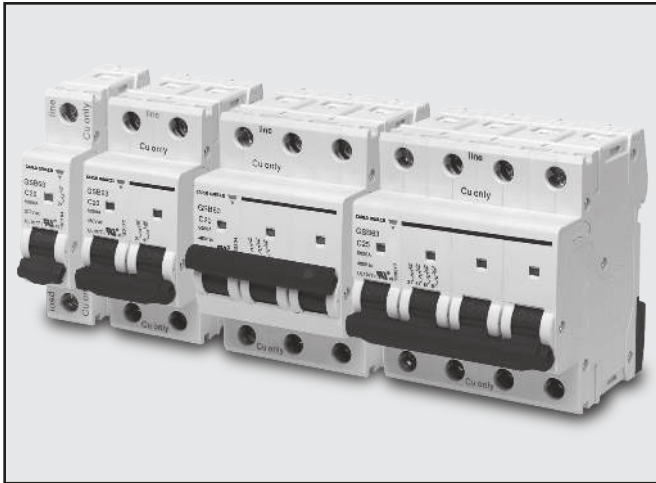

- Protection of circuits against short circuit and overload currents
- UL1077 supplementary protection
- 1, 2, 3 and 4 pole arrangements
- 13 amperage sizes up to 63Amps
- Icn of 5kA
- Bimetallic element for small overloads
- Magnetic element for short circuit protection
- B, C, D trip characteristics
- Full line of bus bars and connectors
- Auxiliary contact, alarm switch and shunt release accessories

Product Description

Competitive line of supplementary circuit protectors are available in 1, 2, 3 and 4 pole configurations, with amperage rating up to 63A and voltage up to 480Y/277VAC. Protection is already provided in applications where branch circuit protection is not required.

Ordering Key

GSB63 1P C 20

Supplementary Protector _____
 Number of poles _____
 Tripping Characteristics _____
 Overload range _____

Selection Guide *(Refer to page 2 for list of valid part numbers)*

SCP	Numbers of poles	Tripping Characteristics	Overload Range (amps)
GSB63 Family	1P	C – C curve	1, 2, 3, 4, 6, 10,
	2P	(standard)	16, 20, 25, 32, 40,
	3P	B – B curve	50, 63
	4P	D – D curve	

Selection Guide

C Curve

In	1-pole	2-pole	3-pole	4-pole
1	GSB63 1P C1	GSB63 2P C1	GSB63 3P C1	GSB63 4P C1
2	GSB63 1P C2	GSB63 2P C2	GSB63 3P C2	GSB63 4P C2
3	GSB63 1P C3	GSB63 2P C3	GSB63 3P C3	GSB63 4P C3
4	GSB63 1P C4	GSB63 2P C4	GSB63 3P C4	GSB63 4P C4
6	GSB63 1P C6	GSB63 2P C6	GSB63 3P C6	GSB63 4P C6
10	GSB63 1P C10	GSB63 2P C10	GSB63 3P C10	GSB63 4P C10
16	GSB63 1P C16	GSB63 2P C16	GSB63 3P C16	GSB63 4P C16
20	GSB63 1P C20	GSB63 2P C20	GSB63 3P C20	GSB63 4P C20
25	GSB63 1P C25	GSB63 2P C25	GSB63 3P C25	GSB63 4P C25
32	GSB63 1P C32	GSB63 2P C32	GSB63 3P C32	GSB63 4P C32
40	GSB63 1P C40	GSB63 2P C40	GSB63 3P C40	GSB63 4P C40
50	GSB63 1P C50	GSB63 2P C50	GSB63 3P C50	GSB63 4P C50
63	GSB63 1P C63	GSB63 2P C63	GSB63 3P C63	GSB63 4P C63

B Curve

In	1-pole	2-pole	3-pole	4-pole
1	GSB631PB1	GSB632PB1	GSB633PB1	GSB634PB1
2	GSB631PB2	GSB632PB2	GSB633PB2	GSB634PB2
3	GSB631PB3	GSB632PB3	GSB633PB3	GSB634PB3
4	GSB631PB4	GSB632PB4	GSB633PB4	GSB634PB4
6	GSB631PB6	GSB632PB6	GSB633PB6	GSB634PB6
10	GSB631PB10	GSB632PB10	GSB633PB10	GSB634PB10
16	GSB631PB16	GSB632PB16	GSB633PB16	GSB634PB16
20	GSB631PB20	GSB632PB20	GSB633PB20	GSB634PB20
25	GSB631PB25	GSB632PB25	GSB633PB25	GSB634PB25
32	GSB631PB32	GSB632PB32	GSB633PB32	GSB634PB32
40	GSB631PB40	GSB632PB40	GSB633PB40	GSB634PB40
50	GSB631PB50	GSB632PB50	GSB633PB50	GSB634PB50
63	GSB631PB63	GSB632PB63	GSB633PB63	GSB634PB63

D Curve

In	1-pole	2-pole	3-pole	4-pole
1	GSB631PD1	GSB632PD1	GSB633PD1	GSB634PD1
2	GSB631PD2	GSB632PD2	GSB633PD2	GSB634PD2
3	GSB631PD3	GSB632PD3	GSB633PD3	GSB634PD3
4	GSB631PD4	GSB632PD4	GSB633PD4	GSB634PD4
6	GSB631PD6	GSB632PD6	GSB633PD6	GSB634PD6
10	GSB631PD10	GSB632PD10	GSB633PD10	GSB634PD10
16	GSB631PD16	GSB632PD16	GSB633PD16	GSB634PD16
20	GSB631PD20	GSB632PD20	GSB633PD20	GSB634PD20
25	GSB631PD25	GSB632PD25	GSB633PD25	GSB634PD25
32	GSB631PD32	GSB632PD32	GSB633PD32	GSB634PD32
40	GSB631PD40	GSB632PD40	GSB633PD40	GSB634PD40
50	GSB631PD50	GSB632PD50	GSB633PD50	GSB634PD50
63	GSB631PD63	GSB632PD63	GSB633PD63	GSB634PD63

Part numbers in bold font indicate stock item

Specifications are subject to change without notice — September-2020

Electrical Specifications

Rated Current	1, 2, 3, 4, 6, 10, 16, 20, 25, 32, 40, 50, 63 A	
Poles	1, 2, 3 or 4 pole	
Rated Voltage	single phase 277 VAC	
	three phase 480Y/277VAC	
Insulation Voltage	500 VAC	
Rated Frequency	50/60 Hz	
Rated Breaking capacity	5,000 A	
Rated Impulse Withstand Voltage (1.2/50)	4,000 V	
Dielectric Test Voltage for 1 minute	2,000 V	
Pollution Degree	2	
Power loss per pole	1, 2, 3, 4, 5, 6, 10 A	2 W
	13, 16, 20, 25, 32 A	3.5 W
	40, 50, 63 A	5 W
Thermo—magnetic release characteristics	B, C (standard), D	
Electrical life	4,000 cycles	

Mechanical Specifications

Mechanical life	20,000 cycles
Contact Position Indicator	Yes
Protection Degree	IP20
Reference Temperature	30°C
Operation Temperature Range	-35°C ~ +70°C (see table on page 3 for derating)
Terminal Connection Type	Copper/U-type busbar/Pin-type busbar
Wire Size Range	18-4 AWG
Busbar size range	18-8 AWG
Maximum tightening torque	22 In-lbs. (N*m 2)
Mounting	Vertical on DIN rail EN 60715 (35mm)
Connection	Line-in on top, line-out on bottom

Temperature Derating

The maximum permissible current in a supplementary protector depends on the ambient temperature and spacing between devices (see next paragraph). Ambient temperature is the temperature inside the enclosure or switch-board in which circuit breaker is installed. The reference temperature for nominal current rating is 30°C.

Ambient Temp >	-35°C	-30°C	-20°C	-10°C	0°C	10°C	20°C	30°C	40°C	50°C	60°C	70°C
Rated Current												
1A	1.30	1.26	1.23	1.19	1.15	1.11	1.05	1.00	0.96	0.93	0.88	0.83
2A	2.60	2.52	2.46	2.38	2.28	2.20	2.08	2.00	1.92	1.86	1.76	1.66
3A	3.90	3.78	3.69	3.57	3.42	3.30	3.12	3.00	2.88	2.79	2.64	2.49
4A	5.20	5.04	4.92	4.76	4.56	4.40	4.16	4.00	3.84	3.76	3.52	3.32
6A	7.80	7.56	7.38	7.14	6.84	6.60	6.24	6.00	5.76	5.64	5.28	4.98
10A	13.20	12.76	12.50	12.00	11.50	11.10	10.60	10.00	9.60	9.30	8.90	8.40
16A	21.12	20.48	20.00	19.20	18.40	17.76	16.96	16.00	15.36	14.88	14.24	13.44
20A	26.40	25.60	25.00	24.00	23.00	22.20	21.20	20.00	19.20	18.60	17.80	16.80
25A	33.00	32.00	31.25	30.00	28.75	27.75	26.50	25.00	24.00	23.25	22.25	21.00
32A	42.56	41.28	40.00	38.72	37.12	35.52	33.92	32.00	30.72	29.76	28.16	26.88
40A	53.20	51.20	50.00	48.00	46.40	44.80	42.40	40.00	38.40	37.20	35.60	33.60
50A	67.00	65.50	63.00	60.50	58.00	56.00	53.00	50.00	48.00	46.50	44.00	41.50
63A	83.79	81.90	80.01	76.86	73.71	70.56	66.78	63.00	60.48	58.90	55.44	52.29

Curve Profiles

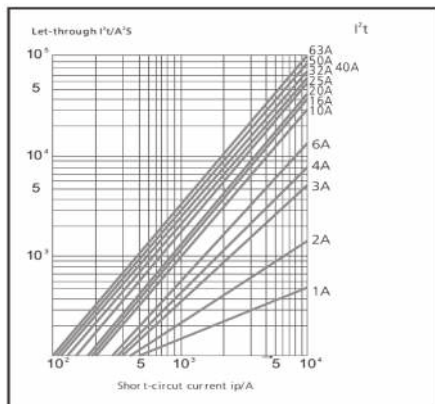
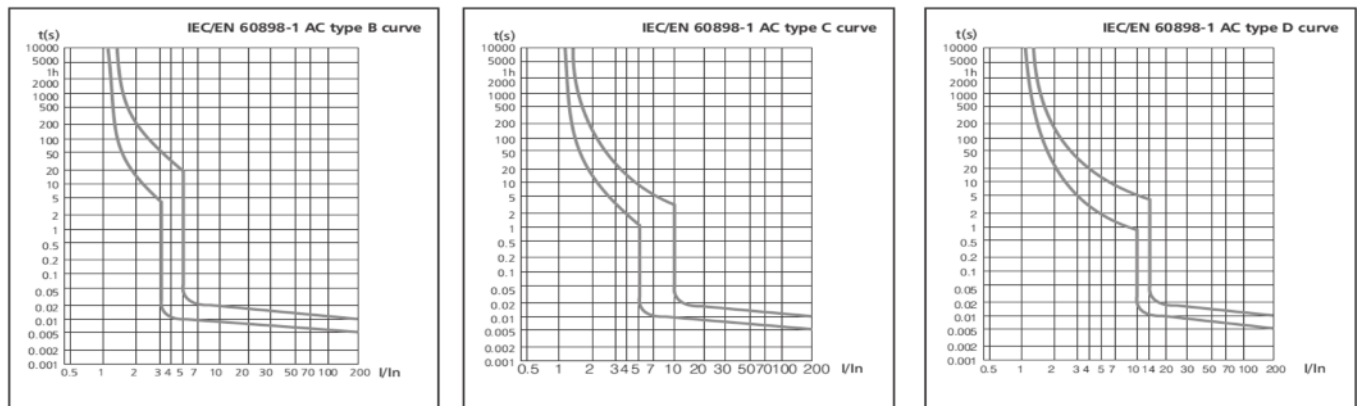

Accessories

Auxiliary Contact

General

Ordering key:

GSBXF9

Indication of the position of the device's contacts. To be mounted on the left side of the UL1077 supplementary protector, thanks to the special pin.

Technical data

Standard	IEC/EN 60947-5-1		
Rated values	Voltage		Current
	AC415 50/60HZ		3A
	AC240 50/60HZ		6A
	DC130		1A
	DC48		2A
	DC24		6A
Electrical features	Configurations		1 N/O + 1 N/C
	Rated impulse withstand voltage (1.2/50)Uimp	V	4000
	Dielectric Test voltage at ind. Freq. for 1min	kV	2
	Insulation voltage Ui	V	500
	Pollution degree		2
Mechanical features	Electrical life		6,050
	Mechanical life		10,000
	Protection degree		IP20
	Ambient temperature (with daily average $\leq 35^{\circ}\text{C}$)	$^{\circ}\text{C}$	-5...+40
	Storage temperature	$^{\circ}\text{C}$	-25...+70
Installation	Terminal connection type T		Cable
	Terminal size top/bottom for cable	mm ²	2.5
		AWG	18 ~ 14
	Tightening torque	N·m	0.8
ln-lbs.		7	
Approvals	CE only		

Alarm Switch

General

Ordering key:

GSBXF9J

Indication of the position of the device's contacts only after the automatic release of the UL1077 supplementary protector, due to an overload or a short-circuit. To be mounted on the left side of the UL1077 device thanks to the special pin.

Technical data

Standard	IEC/EN 60947-5-1		
Rated value	Voltage		Current
	AC415 50/60HZ		3A
	AC240 50/60HZ		6A
	DC130		1A
	DC48		2A
	DC24		6A
Electrical features	Configurations		1 N/O + 1 N/C
	Rated impulse withstand voltage (1.2/50)Uimp	V	4000
	Dielectric test voltage at ind. Freq. for 1min	kV	2
	Insulation voltage Ui	V	500
Mechanical features	Pollution degree		2
	Electrical life		6,050
	Mechanical life		10,000
	Protection degree		IP20
	Ambient temperature (with daily average $\leq 35^{\circ}\text{C}$)	$^{\circ}\text{C}$	-5...+40
	Storage temperature	$^{\circ}\text{C}$	-25...+70
Installation	Terminal connection type		Cable
	Terminal size top/bottom for cable	mm ²	2.5
		AWG	18 ~ 14
	Tightening torque	N·m	0.8
ln-lbs.		7	
Approvals	CE only		

Shunt release

General

Ordering key:

GSBS9

Remote opening of the device when a voltage is applied.

To be mounted on the left side of the UL1077 supplementary protector, thanks to the special pin.

Technical data

Standard	IEC/EN 60947-5-1		
Rated value	Voltage	24VDC	
	Configurations	1 N/O + 1 N/C	
Electrical features	Rated impulse withstand voltage (1.2/50)Uimp	V	4000
	Dielectric TEST voltage at ind. Freq. for 1min	kV	2
	Insulation voltage Ui	V	500
	Pollution degree	2	
Mechanical features	Electrical life	4,000	
	Mechanical life	4,000	
	Protection degree	IP20	
	Ambient temperature (with daily average $\leq 35^{\circ}\text{C}$)	$^{\circ}\text{C}$	-5...+70
	Storage temperature	$^{\circ}\text{C}$	-25...+70
Installation	Terminal connection type	Cable	
	Terminal size top/bottom for cable	mm ²	2.5
		AWG	18 ~ 14
	Tightening torque	N·m	0.8
In-lbs.		7	
Approvals	CE only		

GSB63 — Busbars and Connectors

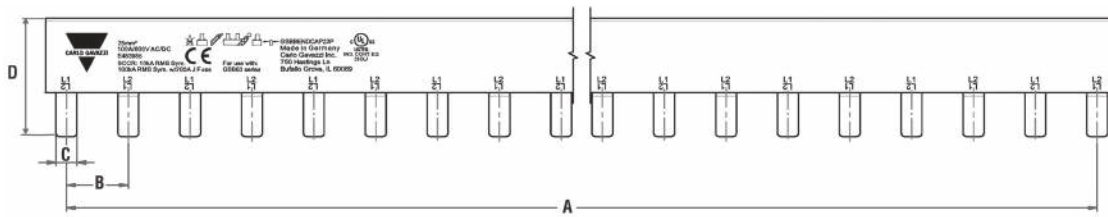

Accessory	Poles	Pins	Part Number	Description	Combined Amperage Rating	Rated voltage	Dimensions [mm / in]							
							A	B	C	D				
Busbar	1	6	GSBB1P06H	6 pins busbar 1 pole GSB	100A	600 VAC / 1000 VDC	89 / 3.5	17.8 / 0.70	5.5 / 0.22	16.7 / 0.66				
		12	GSBB1P12H	12 pins busbar 1 pole GSB	100A		196 / 7.72	17.8 / 0.70	5.5 / 0.22	16.7 / 0.66				
		18	GSBB1P18H	18 pins busbar 1 pole GSB	100A		303 / 11.92	17.8 / 0.70	5.5 / 0.22	16.7 / 0.66				
		57	GSBB1P57H	cuttable 57 pins busbar 1 pole GSB	100A		997 / 39.25	17.8 / 0.70	5.5 / 0.22	15.6 / 0.61				
		37	GSBB1P37HS	cuttable 37 pins busbar 1 pole GSB+AUX	100A		972 / 38.27	17.8 / 0.70	5.5 / 0.22	15.6 / 0.61				
	2	6	GSBB2P06H	6 pins busbar 2 pole GSB	100A	600 VAC / 600 VDC	89 / 3.5	17.8 / 0.70	5.5 / 0.22	36.5 / 1.44				
		12	GSBB2P12H	12 pins busbar 2 pole GSB	100A		196 / 7.72	17.8 / 0.70	5.5 / 0.22	36.5 / 1.44				
		18	GSBB2P18H	18 pins busbar 2 pole GSB	100A		303 / 11.93	17.8 / 0.70	5.5 / 0.22	36.5 / 1.44				
		56	GSBB2P56H	cuttable 57 pins busbar 2 pole GSB	100A		979 / 38.54	17.8 / 0.70	5.5 / 0.22	36.5 / 1.44				
		46	GSBB2P46HS	cuttable 37 pins busbar 2 pole GSB+AUX	100A		968 / 38.11	17.8 / 0.70	5.5 / 0.22	36.5 / 1.44				
	3	6	GSBB3P06H	6 pins busbar 3 pole GSB	100A	600 VAC / 600 VDC	89 / 3.5	17.8 / 0.70	5.5 / 0.22	36.5 / 1.44				
		12	GSBB3P12H	12 pins busbar 3 pole GSB	100A		196 / 7.72	17.8 / 0.70	5.5 / 0.22	36.5 / 1.44				
		18	GSBB3P18H	18 pins busbar 3 pole GSB	100A		303 / 11.93	17.8 / 0.70	5.5 / 0.22	36.5 / 1.44				
		57	GSBB3P57H	cuttable 57 pins busbar 3 pole GSB	100A		997 / 39.25	17.8 / 0.70	5.5 / 0.22	36.5 / 1.44				
		48	GSBB3P48HS	cuttable 37 pins busbar 3 pole GSB+AUX	100A		935 / 36.81	17.8 / 0.70	5.5 / 0.22	36.5 / 1.44				
Feeder	1		GSBBFEED1P	Feeder terminal 1 pole GSB	115A	600 VAC / 600 VDC	Part number in bold font indicate stock items							
	2, 3		GSBBFEED23P	Feeder terminal 2 & 3 pole GSB	115A									
Center feeder	all		GSBBCENFEED	Center feeder terminal	115A									
End cap	1		GSBBENDCAP1P	End cover 1 pole GSB	n / a	n / a					Approvals - CE, cULus (UL508)			
	2, 3		GSBBENDCAP23P	End cover 2 & 3 pole GSB										
Pin cap	all		GSBBPINCAP	Protective pin cap										

Dimensions

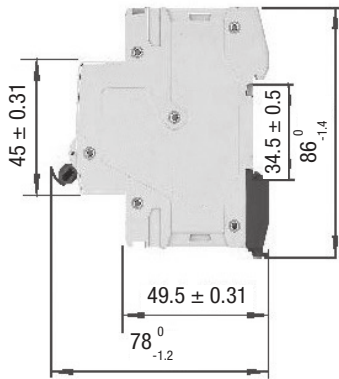

1P



1P+N, 2P

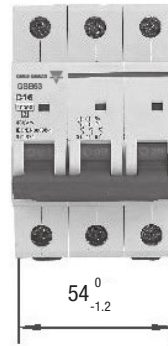

3P

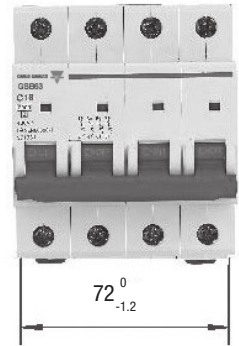

3P+N, 4P

Agency Approvals

GSB Supplementary Protectors



GSB Supplementary Protectors



GSBB Busbars and Busbar Accessories

