

Buffer Amplifier, GaAs MMIC

4 - 11 GHz



XB1007-QT
Rev. V2

Features

- Excellent Transmit LO/Output Buffer Stage
- 23 dB Small Signal Gain
- 19 dBm P1dB Compression Point
- 4.5 dB Noise Figure
- Variable Gain with Adjustable Bias
- 100% RF, DC and Output Power Testing
- Lead-Free 3 mm, 16-lead QFN
- RoHS* Compliant

Applications

- Microwave and Millimeter-wave Point-to-Point Radio, LMDS, SATCOM and VSAT

Description

The XB1007-QT is a two stage 4 - 11 GHz GaAs MMIC buffer amplifier. The device is assembled in a lead-free 3 mm QFN surface mount package offering excellent RF and thermal properties. This amplifier has a small signal gain of 23 dB with a 20 dBm P1dB output compression point. The device also provides variable gain regulation with adjustable bias. The device is ideally suited as an LO or RF buffer stage with broadband performance.

Ordering Information^{1,2}

Part Number	Package
XB1007-QT-0G00	Bulk Packaging
XB1007-QT-0G0T	Tape & Reel
XB1007-QT-EV1	Sample Board

1. Reference Application Note M513 for reel size information.
2. All sample boards include 5 loose parts.

Functional Schematic

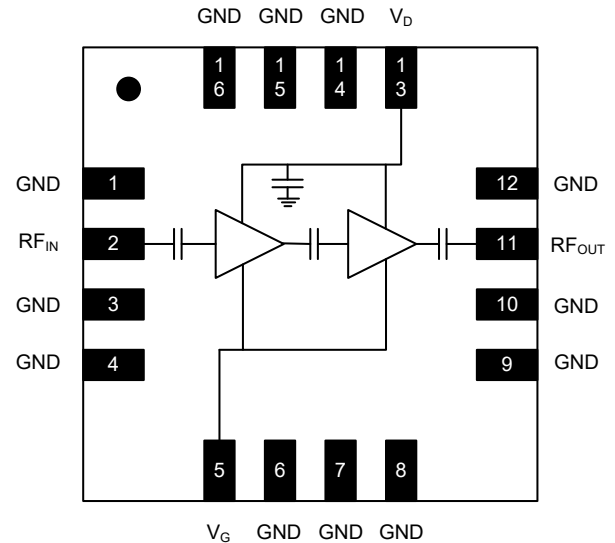

Pin Configuration³

Pin #	Function
1,3,4,6,7,8,9,10,12,14,15,16	GND
2	RF _{IN}
5	VG
11	RF _{OUT}
13	VD
17	Paddle ⁴

3. MACOM recommends connecting unused package pins to ground.
4. The exposed pad centered on the package bottom must be connected to RF, DC and thermal ground.

* Restrictions on Hazardous Substances, compliant to current RoHS EU directive.

Electrical Specifications: Freq. = 4 - 11 GHz, $T_A = +25^\circ\text{C}$, $V_D = 4\text{ V}$, $Z_0 = 50\ \Omega$

Parameter	Units	Min.	Typ.	Max.
Small Signal Gain	dB	—	23	—
Input Return Loss	dB	—	20	—
Output Return Loss	dB	—	12	—
Gain Flatness	dB	—	+/- 1.5	—
Reverse Isolation	dB	—	50	—
Noise Figure	dB	—	4.5	—
P1dB	dBm	—	19	—
Saturated Output Power	dBm	—	21	—
Output IP3	dBm	—	31	—
Drain Bias Voltage	V	—	4	—
Gate Bias Voltage	V	-1.0	-0.35	-0.1
Supply Current ($V_D = 4\text{ V}$, $V_G = -0.5\text{ V}$)	mA	—	100	130

Absolute Maximum Ratings^{5,6}

Parameter	Absolute Maximum
Input Power	20 dBm
Drain Voltage	4.3 V
Gate Voltage	0 V
Junction Temperature ⁷	+150°C
Operating Temperature	-40°C to +85°C
Storage Temperature	-65°C to +165°C

5. Exceeding any one or combination of these limits may cause permanent damage to this device.
6. MACOM does not recommend sustained operation near these survivability limits.
7. Operating at nominal conditions with $T_J \leq +150^\circ\text{C}$ will ensure MTTF > 1×10^6 hours.

Handling Procedures

Please observe the following precautions to avoid damage:

Static Sensitivity

Gallium Arsenide Integrated Circuits are sensitive to electrostatic discharge (ESD) and can be damaged by static electricity. Proper ESD control techniques should be used when handling these HBM class 1A devices.

Typical Performance Curves

Gain, 4 V, 100 mA

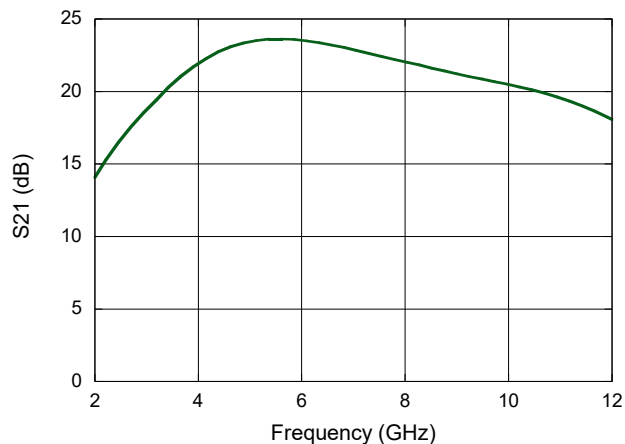

Reverse Isolation, 4 V, 100 mA

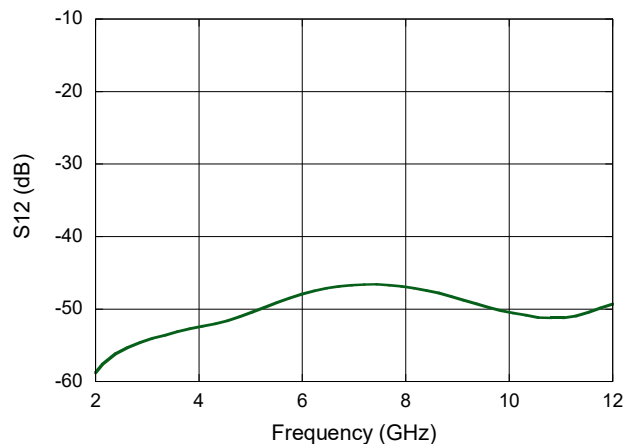

Input Return Loss, 4 V, 100 mA

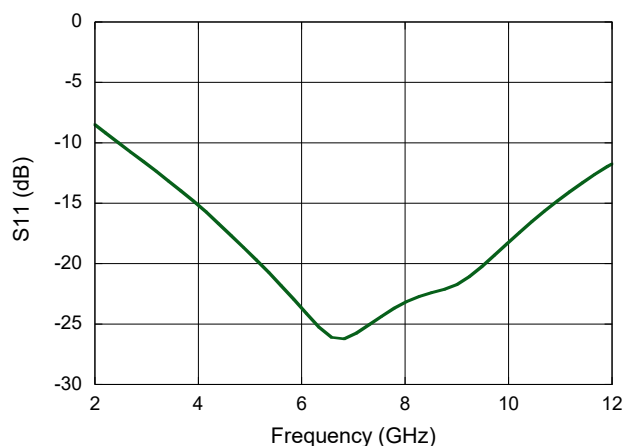

Output Return Loss, 4 V, 100 mA

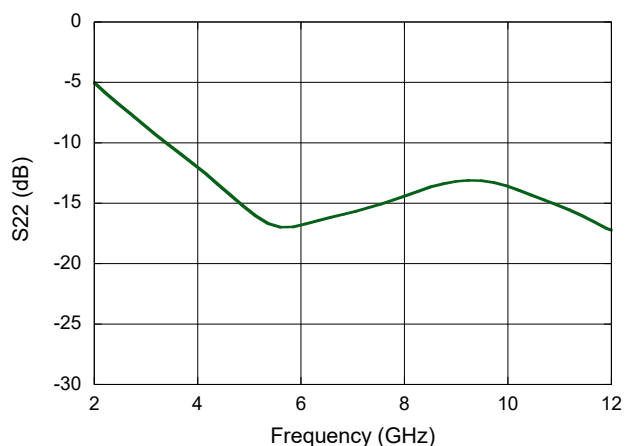

P1dB, 4 V, 130 mA

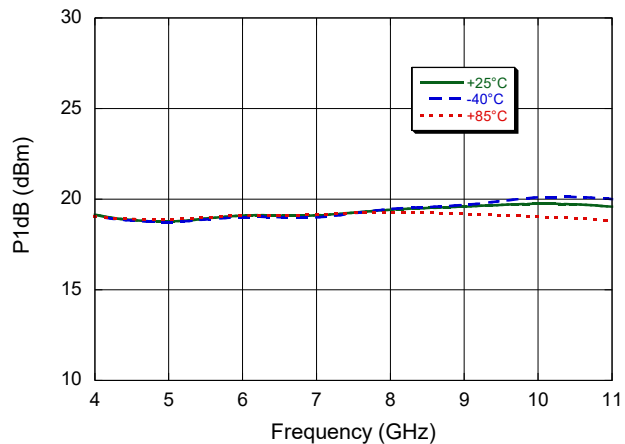

Saturated Output Power, 4 V, 130 mA

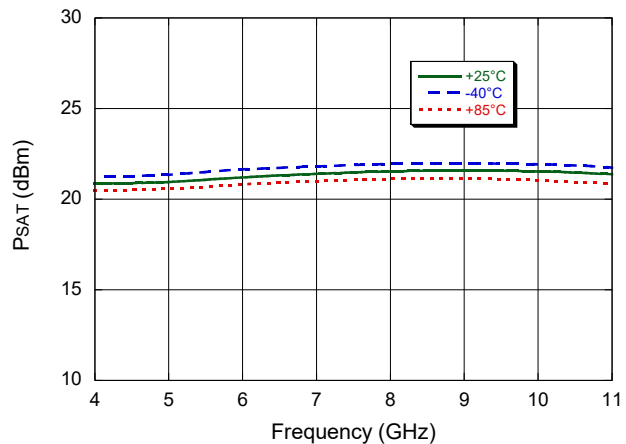

Typical Performance Curves

Output IP3 vs. Frequency

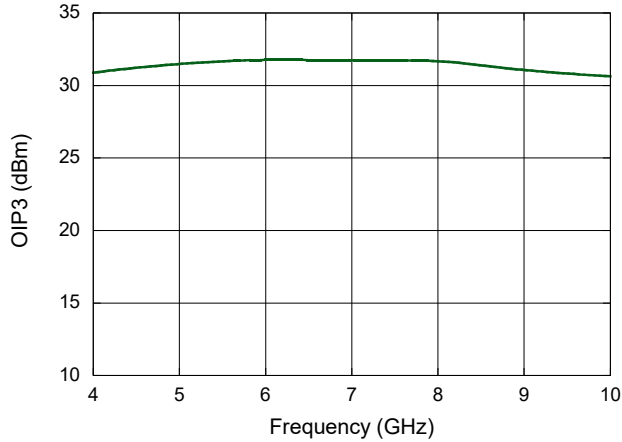

Output IP3 vs. Gain

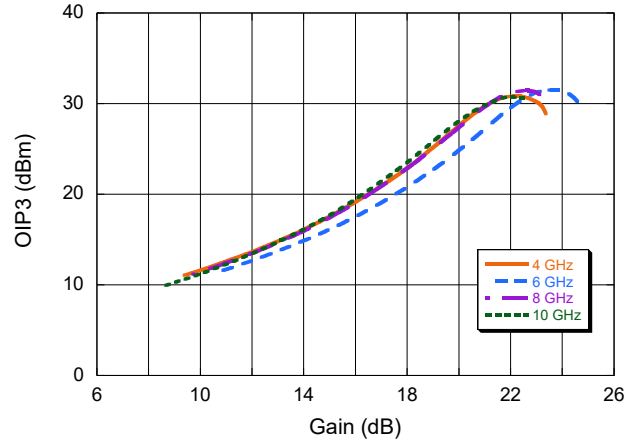

Output IP3 vs. Current

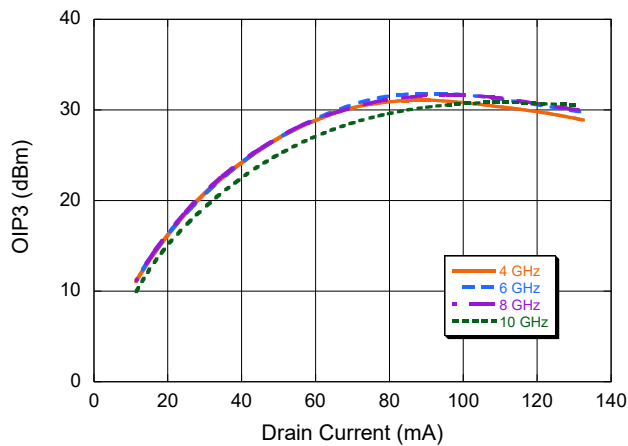

Noise Figure vs. Frequency

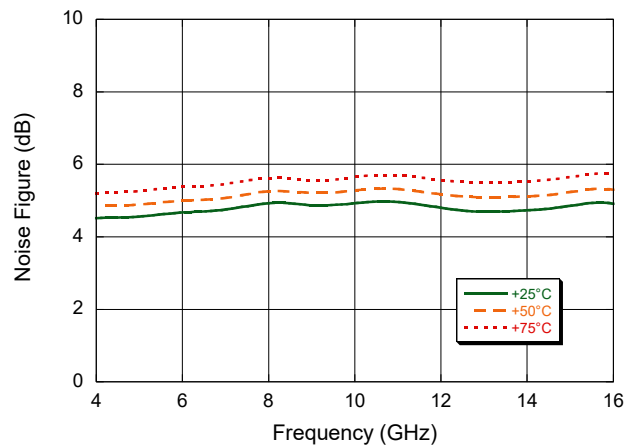

Buffer Amplifier, GaAs MMIC 4 - 11 GHz



XB1007-QT
Rev. V2

Lead-Free 3 mm 16-Lead PQFN[†]

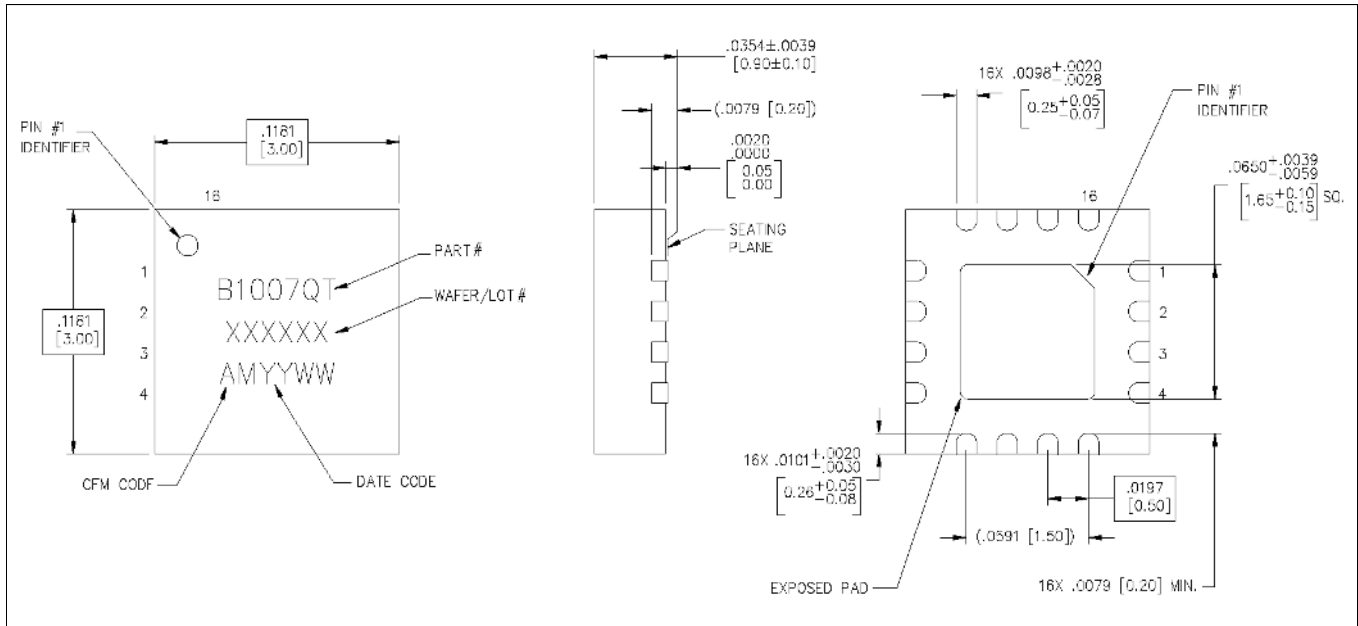

[†] Reference Application Note S2083 for lead-free solder reflow recommendations.
Meets JEDEC moisture sensitivity level 1 requirements.
Plating is 100% matte tin over copper.

Applications Section

App Note [1] Biasing -

The device provides variable gain with adjustable bias regulation. For optimum linearity performance, it is recommended to bias this device at $V_D = 4\text{ V}$ with $I_D = 100\text{ mA}$. It is also recommended to use active biasing to control the drain currents because this gives the most reproducible results over temperature or RF level variations. Depending on the supply voltage available and the power dissipation constraints, the bias circuit may be a single transistor or a low power operational amplifier, with a low value resistor in series with the drain supply used to sense the current. The gate of the pHEMT is controlled to maintain correct drain current and thus drain voltage. The typical gate voltage needed to do this is -0.5 V . Typically the gate is protected with Silicon diodes to limit the applied voltage. Also, make sure to sequence the applied voltage to ensure negative gate bias is available before applying the positive drain supply.

MTTF Graphs

These numbers were calculated based on accelerated life test information and thermal model analysis received from the fabricating foundry.

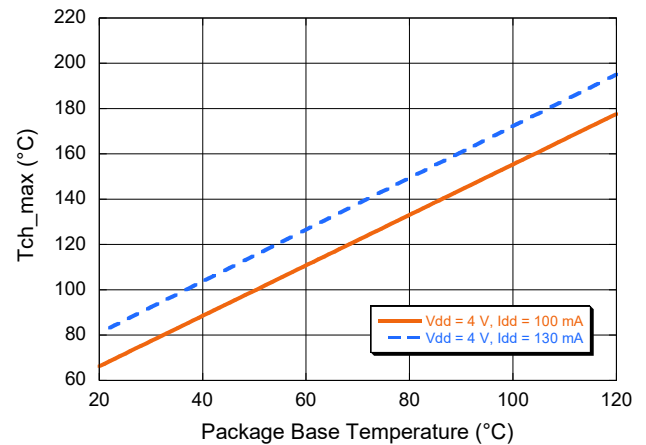
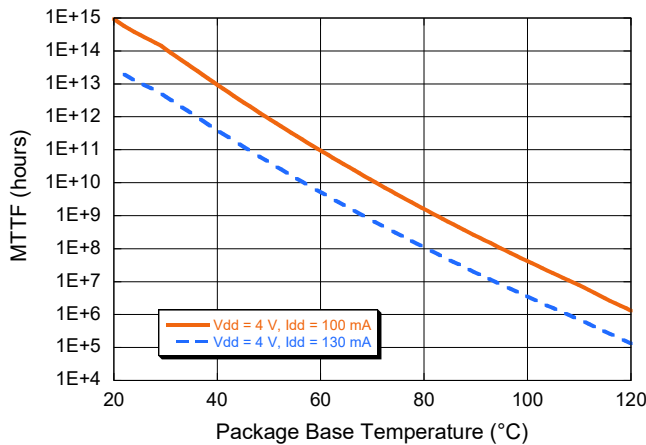

MACOM Technology Solutions Inc. ("MACOM"). All rights reserved.

These materials are provided in connection with MACOM's products as a service to its customers and may be used for informational purposes only. Except as provided in its Terms and Conditions of Sale or any separate agreement, MACOM assumes no liability or responsibility whatsoever, including for (i) errors or omissions in these materials; (ii) failure to update these materials; or (iii) conflicts or incompatibilities arising from future changes to specifications and product descriptions, which MACOM may make at any time, without notice. These materials grant no license, express or implied, to any intellectual property rights.

THESE MATERIALS ARE PROVIDED "AS IS" WITH NO WARRANTY OR LIABILITY, EXPRESS OR IMPLIED, RELATING TO SALE AND/OR USE OF MACOM PRODUCTS INCLUDING FITNESS FOR A PARTICULAR PURPOSE, MERCHANTABILITY, INFRINGEMENT OF INTELLECTUAL PROPERTY RIGHT, ACCURACY OR COMPLETENESS, OR SPECIAL, INDIRECT, INCIDENTAL, OR CONSEQUENTIAL DAMAGES WHICH MAY RESULT FROM USE OF THESE MATERIALS.

MACOM products are not intended for use in medical, lifesaving or life sustaining applications. MACOM customers using or selling MACOM products for use in such applications do so at their own risk and agree to fully indemnify MACOM for any damages resulting from such improper use or sale.