

MC21603A6W-SPR-V2	2 x 16	3mm Character Height	LCD Module
Specification			
Version: 1		Date: 28/10/2020	
Revision			
1	26/10/2020	First Issue	

Display Features		
Character Count	2 x 16	
Appearance	Black on Yellow/Green	
Logic Voltage	5V	
Interface	Parallel	
Font Set	English / Japanese	
Display Mode	Reflective	
Character Height	3.15mm	
LC Type	STN	
Module Size	53.00 x 20.00 x 8.00mm	
Operating Temperature	-20°C ~ +70°C	
Construction	COB	Box Quantity
LED Backlight	---	Weight / Display



RoHS
compliant

* - For full design functionality, please use this specification in conjunction with the ST7066U specification. (Provided Separately)

Display Accessories	
Part Number	Description
MDC16-1-BC	16 way connector with 1mm pitch.

Optional Variants		
Fonts	Appearances	Voltage



1. FUNCTIONS & FEATURES

- MC21603A6W-SPR-V2 Series LCD type :
- Viewing Direction : 6 O'clock
- Driving Scheme : 1/16 Duty, 1/5 Bias
- Power Supply Voltage : 5.0V
- LCD Operation Voltage : 4.6V
- Display contents : 16 Characters x 2 line
- Internal Memory : CGROM (13200bits)
: CGRAM (64 x 8bits)
: DDRAM (80 x 8 bits for Digits)
- CGROM : CGROM of the ST7066U-0A
- 8-Bit Parallel
- RoHS Compliant

2. MECHANICAL SPECIFICATIONS

- Module Size : 53.00(L) x 20.00(W) x 8.00(H)mm
- Viewing area : 36.00(L) x 10.00 (W) mm
- Active area : 34.10(L) x 7.40(W) mm
- Dot Size : 0.33 (L) x 0.35 (W) mm
- Dot Gap : 0.05mm

design • manufacture • supply



EXTERNAL DIMENSIONS

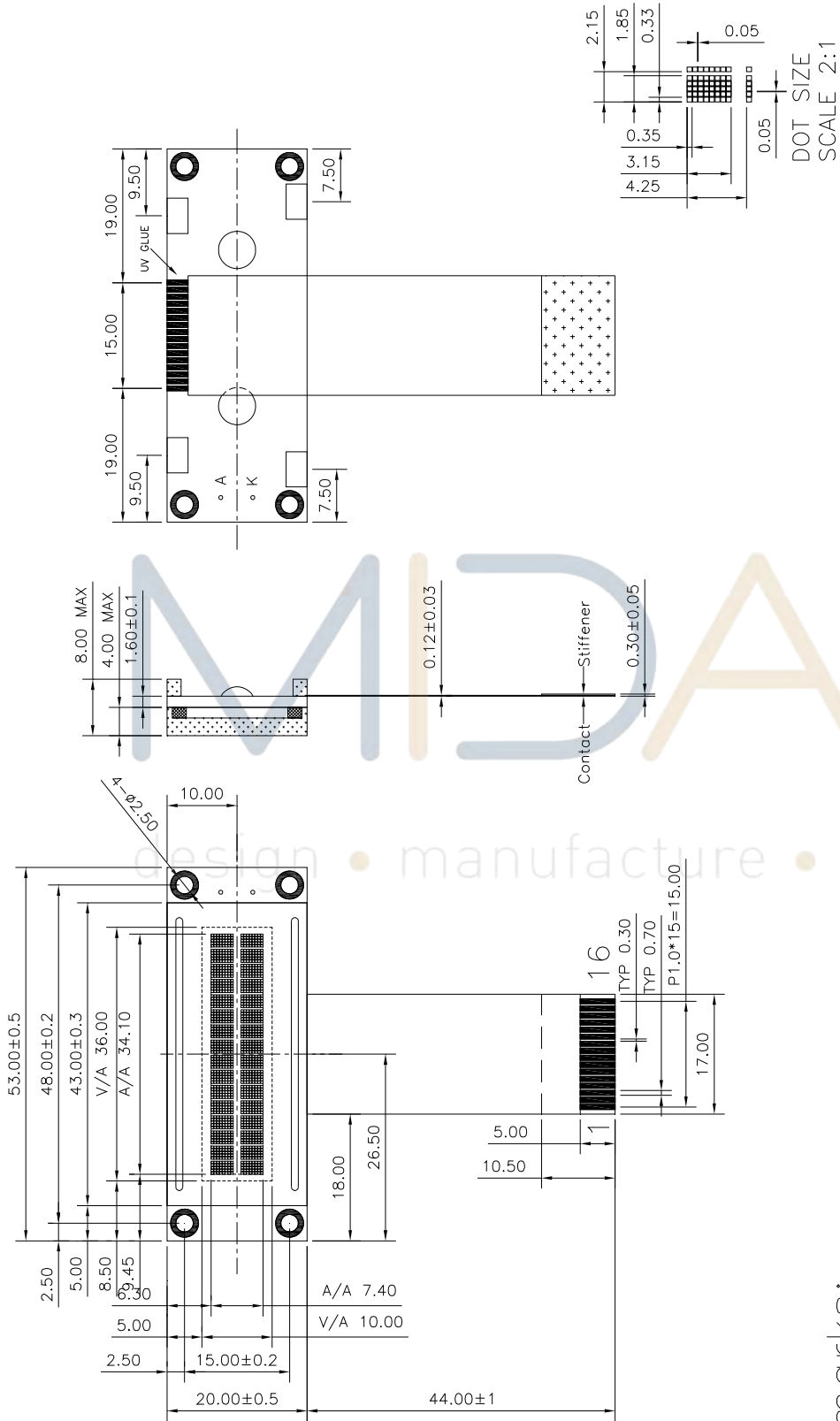

Remarks:

1. Unmarked tolerance is ± 0.3
2. All materials comply with RoHs
3. ...:critical dimension.

BLOCK DIAGRAM

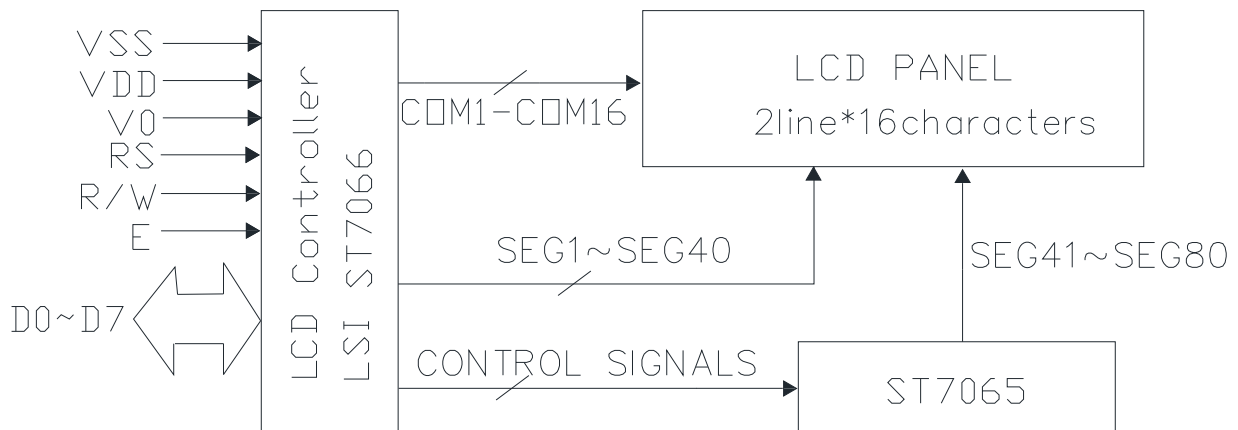

PIN ASSIGNMENT

Pin No.	Symbol	Function
1	VSS	Ground
2	VDD	Supply Voltage for logic
3	V0	Operating voltage for LCD
4	RS	H:DATA,L:instruction code
5	R/W	H:Read(Module→MPU) L: (MPU→Module)
6	E	Chip enable signal
7	DB0	Date bus line
8	DB1	
9	DB2	
10	DB3	
11	DB4	
12	DB5	
13	DB6	
14	DB7	
15	A	NC
16	K	NC

MAXIMUM ABSOLUTE POWER RATINGS

Item	Symbol	Standard value	Unit
Supply voltage for logic	V_{DD}	-0.3~+7.0	V
Supply voltage for LCD	V_{LCD}	-0.3~10 $V_{CC}+0.3$	V
Input voltage	V_{IN}	0.3~ $V_{CC}+0.3$	V
Operating temperature	T_{opr}	-20~+70	°C
Storage temperature	T_{stg}	-30~+80	°C

DC CHARACTERISTICS

Item	Symbol	Standard Value			Test Condition	Unit
		MIN	TYP	MAX		
Supply Voltage For Logic	$V_{DD}-V_{SS}$	—	5.0	—	—	V
Supply Voltage For LCD *Note	$V_{DD}-V_0$	—	—	—	—	V
		—	4.6	—		V
		—	—	—		V
Input High Volt.	V_{IH}	0.7 V_{DD}	—	V_{DD}	—	V
Input Low Volt.	V_{IL}	-0.3	—	0.6	—	V
Output High Volt.	V_{OH}	3.9	—	V_{DD}	—	V
Output Low Volt.	V_{OL}	0	—	0.4	—	V
Supply Current	I_{DD}	1.0	1.2	1.5	$V_{DD}=5.0V$	mA

* Note: Please design the VOP adjustment circuit on customer's main board

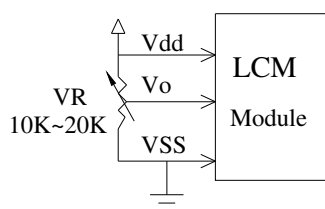

AC CHARACTERISTICS

1. Write mode

Characteristic	Symbol	Min	Type	Max	Unit	Test PIN
Enable Cycle Time	t_C	1200	---	---	ns	E
Enable Pulse Time	T_{PW}	140	---	---	ns	E
Enable Rise/Fall Time	T_R, T_F	---	---	25	ns	E
Address Set-up Time	T_{AS}	0	---	---	ns	RW,RS,E
Address Hold Time	T_{AH}	10	---	---	ns	RW,RS,E
Data Set-up Time	T_{DSW}	40	---	---	ns	DB0~DB7
Data Hold Time	T_H	10	---	---	ns	DB0~DB7

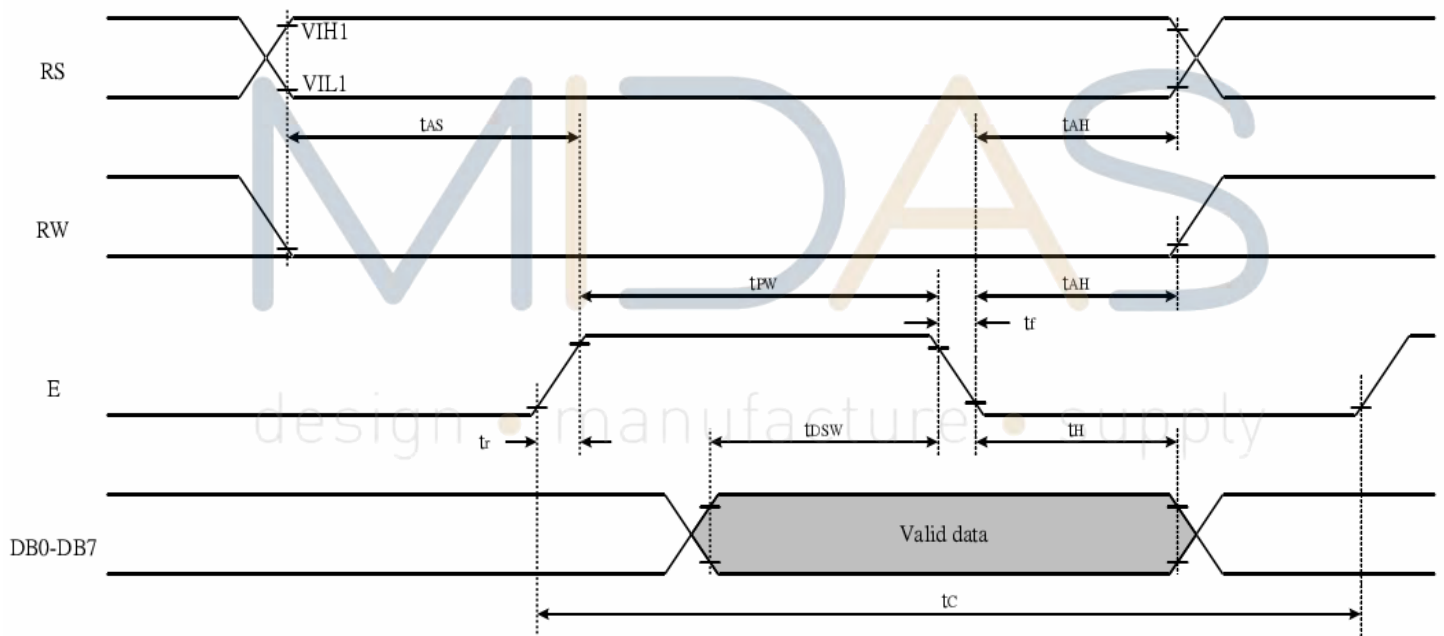

2. Read Mode

Characteristic	Symbol	Min	Type	Max	Unit	Test PIN
Enable Cycle Time	t_C	1200	---	---	ns	E
Enable Pulse Time	T_{PW}	140	---	---	ns	E
Enable Rise/Fall Time	T_R, T_F	---	---	25	ns	E
Address Set-up Time	T_{AS}	0	---	---	ns	RW,RS,E
Address Hold Time	T_{AH}	10	---	---	ns	RW,RS,E
Data Set-up Time	T_{DDR}	---	---	100	ns	DB0~DB7
Data Hold Time	T_H	10	---	---	ns	DB0~DB7

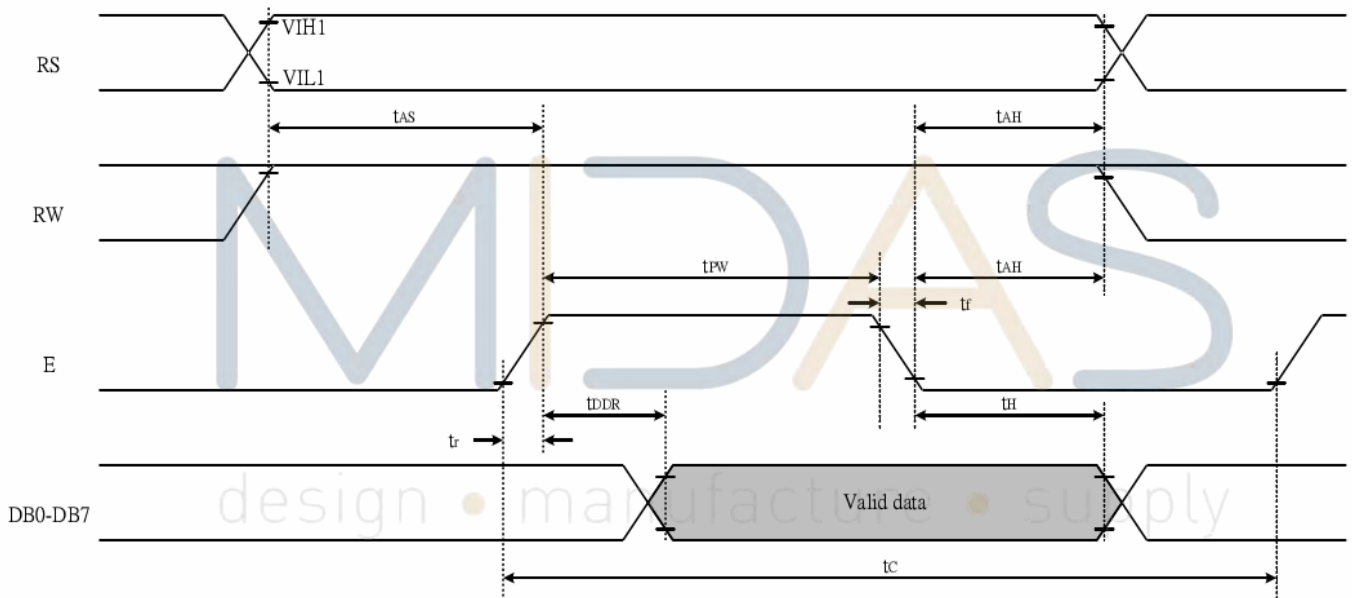

STANDARD CHARACTER PATTERN (ST7066U-0A)

NO.7066-0A

b7-b4 b3-b0	0000	0001	0010	0011	0100	0101	0110	0111	1000	1001	1010	1011	1100	1101	1110	1111
0000	CG RAM (1)			0	a	P	^	P				-	9	3	0	P
0001	(2)		!	1	A	Q	a	9			.	7	7	G	3	q
0010	(3)		"	2	B	R	b	r			r	4	W	X	p	e
0011	(4)		#	3	C	S	c	s			u	0	7	e	c	o
0100	(5)		\$	4	D	T	d	t			v	i	t	t	u	a
0101	(6)		%	5	E	U	e	u			*	7	6	1	0	0
0110	(7)		&	6	F	V	f	v			9	0	=	3	p	z
0111	(8)		*	7	G	W	g	w			7	7	X	9	g	x
1000	(1)		<	8	H	X	h	x			4	0	*	U	r	X
1001	(2)		>	9	I	Y	i	y			6	7	7	U	7	Y
1010	(3)		*	:	J	Z	j	z			5	0	0	V	j	7
1011	(4)		+	;	K	L	k	l			*	9	E	0	*	A
1100	(5)		,	<	L	*	l	l			t	9	7	7	0	A
1101	(6)		-	=	N	I	n	7			u	z	>	U	t	+
1110	(7)		.	>	N	^	n	+			3	E	t	^	n	
1111	(8)		/	?	O	L	o	e			u	U	7	"	o	



INSTRUCTION TABLE

Command	RS	R/W	DB7	DB6	DB5	DB4	DB3	DB2	DB1	DB0	Execution time (fosc=270KHz)	Remark
Clear Display	0	0	0	0	0	0	0	0	0	1	1.52ms	Write "20H" to DDRAM. And set DDRAM address to "00H" from AC
Return home	0	0	0	0	0	0	0	0	1	x	1.52ms	Set DDRAM address to "00H" from AC and return cursor to its original position if shifted. The contents of DDRAM are not changed.
Entry mode Set	0	0	0	0	0	0	0	1	I/D	S	37us	Sets cursor move direction and specifies display shift. These operations are performed during data write and read.
Display on/off control	0	0	0	0	0	0	1	D	C	B	37us	D=1: entire display on C=1: cursor on B=1: cursor position on
Cursor or Display Shift	0	0	0	0	0	1	S/C	R/L	x	x	37us	Set cursor moving and display shift control bit, and the direction, without changing DDRAM data.
function Set	0	0	0	0	1	DL	N	F	x	x	37us	DL: interface data is 8/4 bits N: number of line is 2/1 F: font size is 5x11/5x8
Set CGRAM address	0	0	0	1	AC5	AC4	AC3	AC2	AC1	AC0	37us	Set CGRAM address in address counter
Set DDRAM address	0	0	1	AC6	AC5	AC4	AC3	AC2	AC1	AC0	37us	Set DDRAM address in address counter
Read busy flag& address	0	1	BF	AC6	AC5	AC4	AC3	AC2	AC1	AC0	0us	Whether during internal operation or not can be known by reading BF. The contents of address counter can also be read.
Write data to RAM	1	0	D7	D6	D5	D4	D3	D2	D1	D0	37us	Write data into internal RAM (DDRAM/CGRAM)
Read data from RAM	1	1	D7	D6	D5	D4	D3	D2	D1	D0	37us	Read data from internal RAM (DDRAM / CGRAM)

Note:

Be sure the ST7066U is not in the busy state (BF=00) before sending an instruction from the MPU to the ST7066U. If an instruction is sent without checking the busy flag, the time between the first instruction and next instruction will take much longer than the instruction time itself. Refer to instruction table for the list of each instruction execution time.



RESET FUNCTION

8-bit Interface ($f_{osc}=270\text{KHz}$)

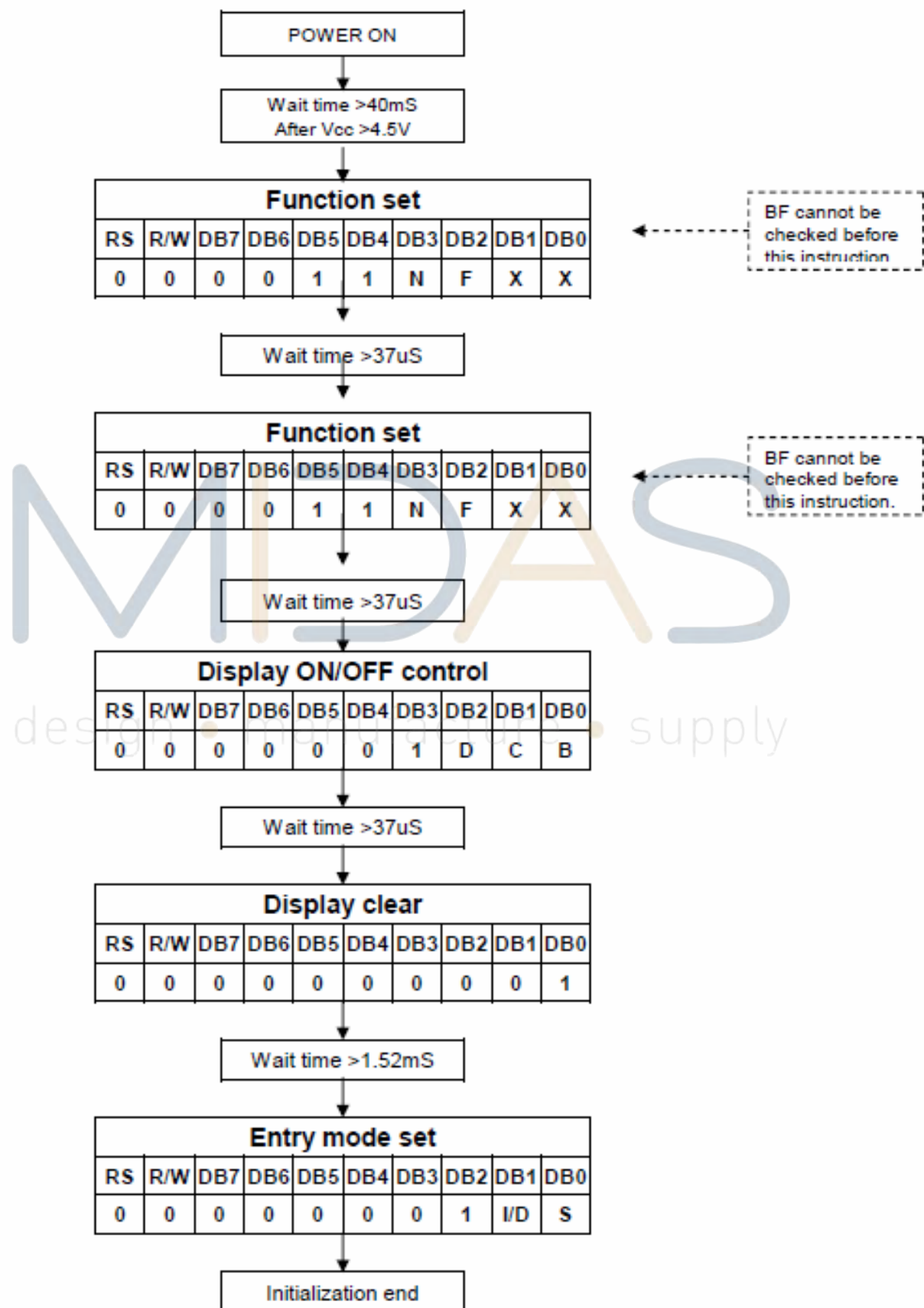

4-bit Interface (fosc=270KHz)

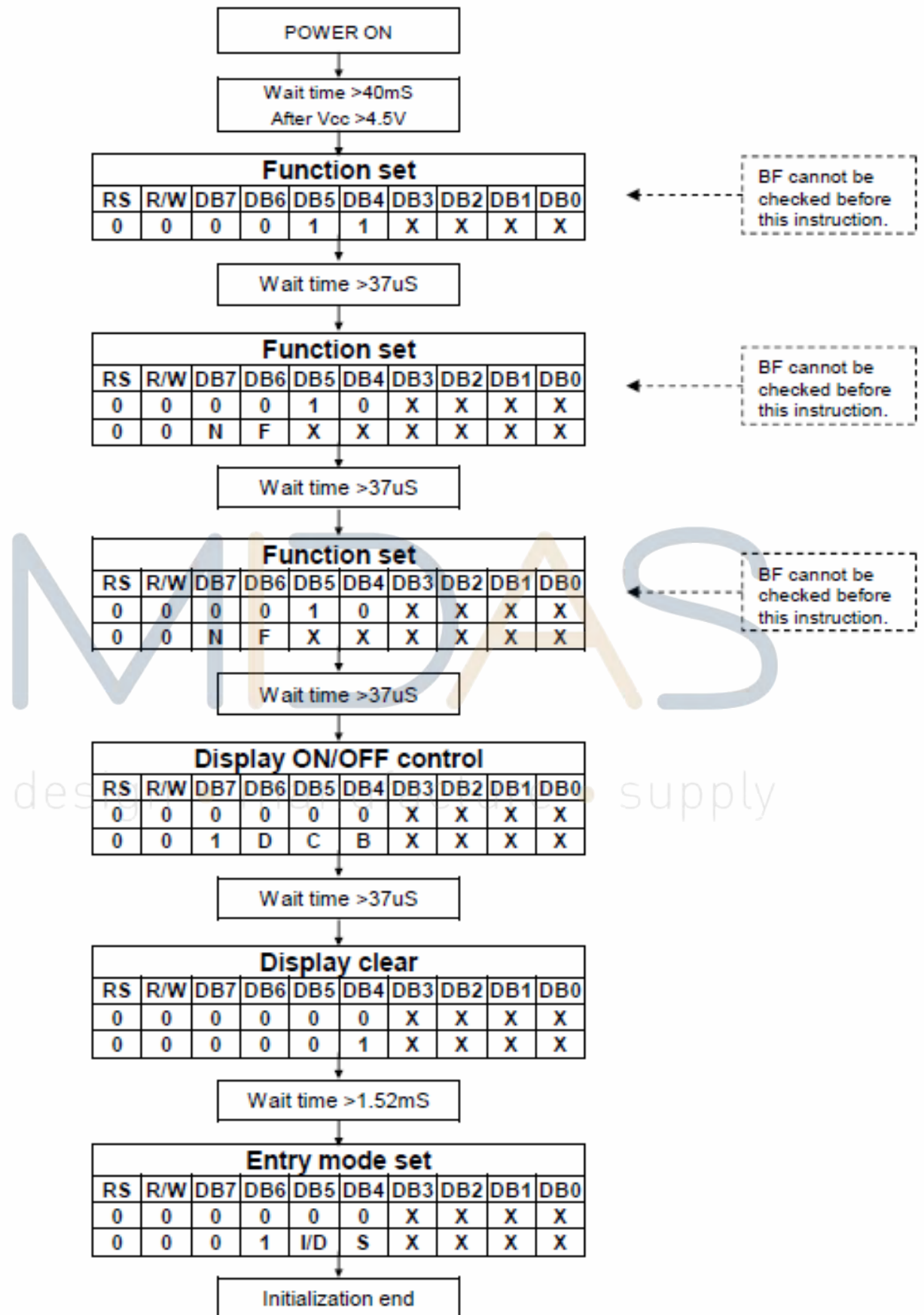

LCD ARTWORK

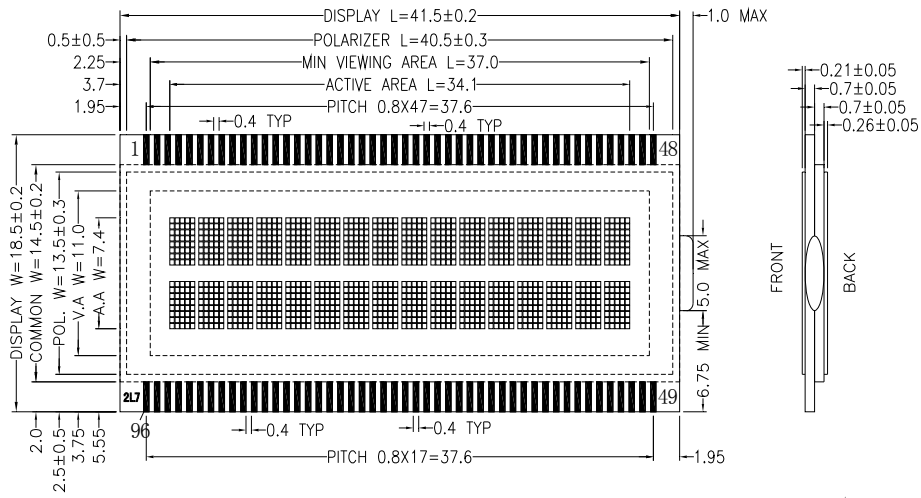

UNLESS OTHERWISE SPECIFIED
DIMENSIONS ARE IN MM
TOLERANCES:±0.2MM



LABELLING

design • manufacture • supply

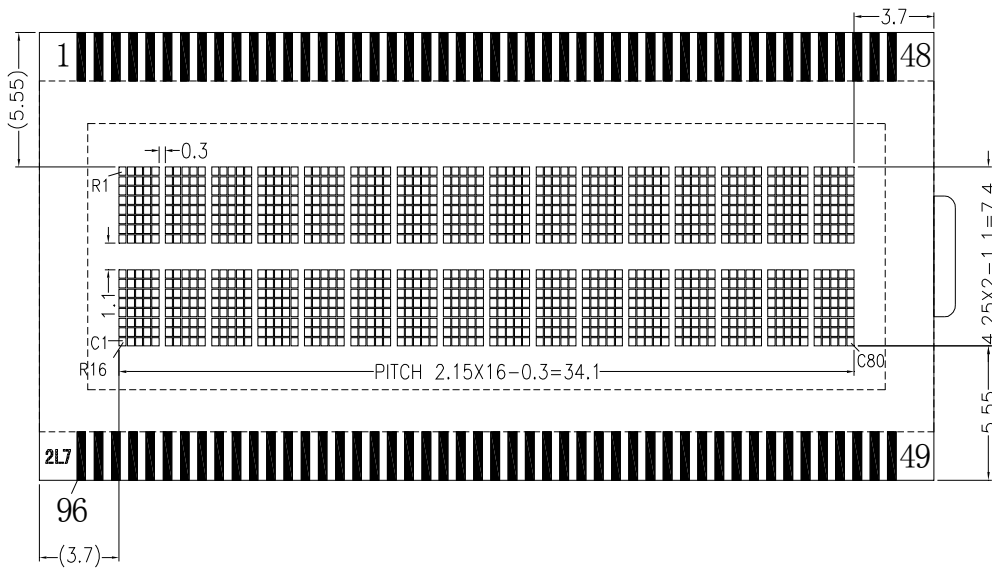

UNLESS OTHERWISE SPECIFIED
DIMENSIONS ARE IN MM
TOLERANCES:±0.2MM



PAD CONFIGURATION & GRAPHIC DIMENSION

PAD NO.	PAD CONFIGURATION
1	COM8[R8(C1-C80)]
2	COM7[R7(C1-C80)]
8	COM1[R1(C1-C80)]
9	SEG21[C21(R1-R16)]
28	SEG40[C40(R1-R16)]
29	SEG61[C61(R1-R16)]
48	SEG80[C80(R1-R16)]
49	COM9[R9(C1-C80)]
56	COM16[R16(C1-C80)]
57	SEG60[C60(R1-R16)]
76	SEG41[C41(R1-R16)]
77	SEG20[C20(R1-R16)]
96	SEG1[C1(R1-R16)]

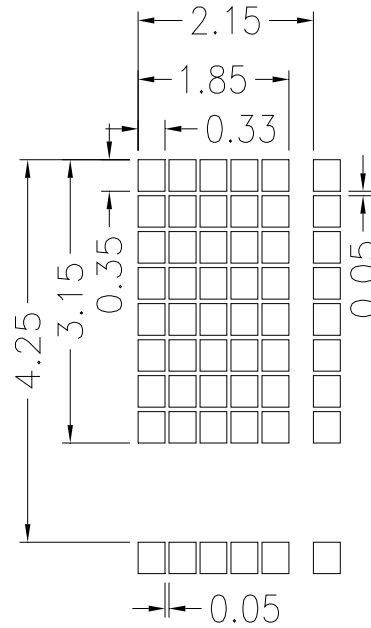

UNLESS OTHERWISE SPECIFIED
DIMENSIONS ARE IN MM
TOLERANCES: ±0.1MM

MIDAS
design • manufacture • supply



SEG & COM LAYOUT

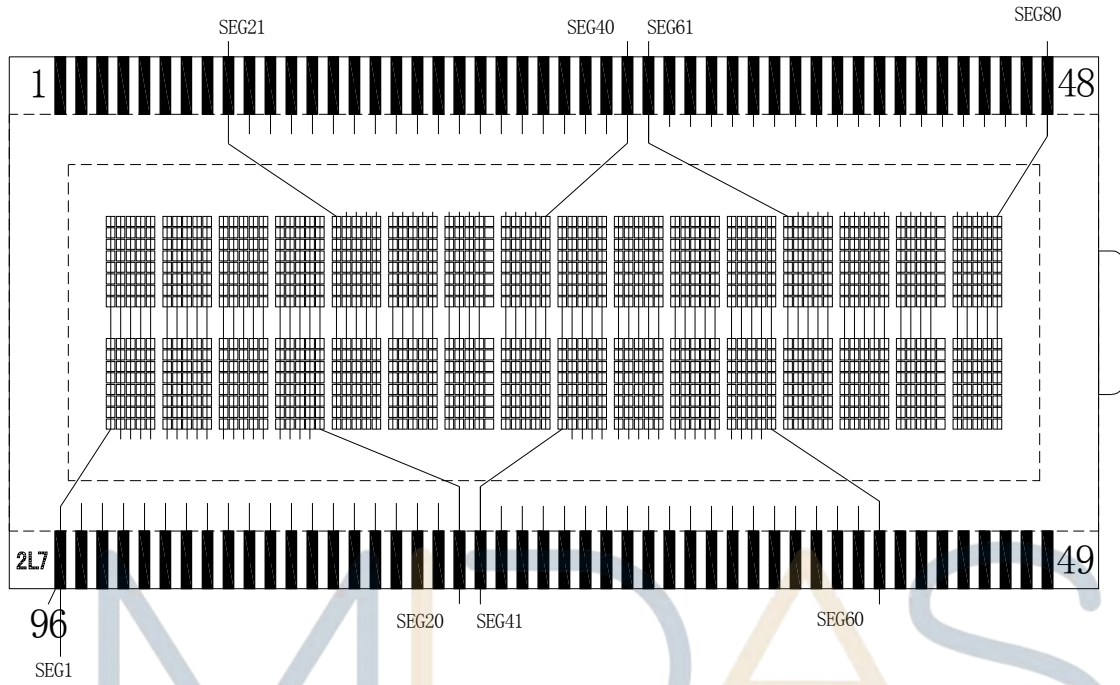

SEG LAYOUT

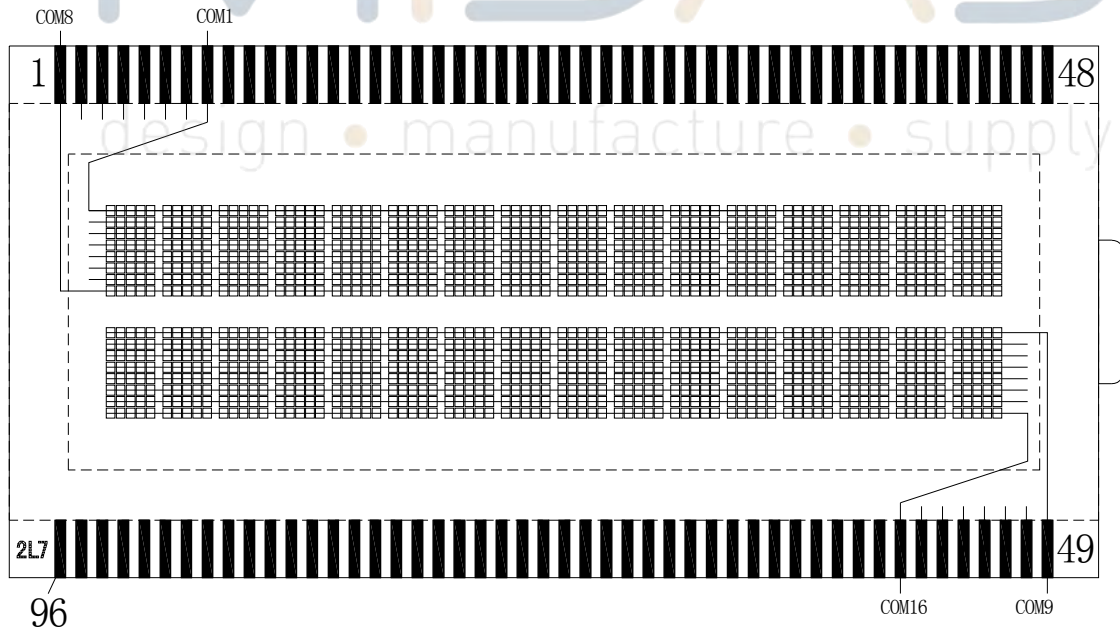

COM LAYOUT



THE MODULE ACCEPT QUALITY LEVEL (AQL)

1. Inspection Standard: ANSI Z-1.4 Table Normal Inspection Single Sampling Level II.

RELIABILITY TEST

Operating life time: 50,000 hours

(at room temperature without direct irradiation of sunlight)

Reliability characteristics shall meet following requirements.

Tests Item	Condition
High temperature storage	+80°C x 96HRS
Low temperature storage	-30°C x 4HRS
High temperature operation	+70°C x 96HRS
Low temperature operation	-20°C x 4HRS
High temperature, High humidity	+60°C x 95%RH x 96HRS
Thermal shock	-20°C x 30min → 25°C x 10s → +70°C x 30 min x 5 cycles
Vibration test	Frequency x Swing x Time 40Hz x 4mm x 4hrs
Drop test	Drop height*Times 1.0m * 6times

QUALITY DESCRIPTION & APPLICATION NOTE • supply

Please refer to “General Inspection Criteria” document

