



2SC5415A

RF Transistor 12V, 100mA, $f_T=6.7\text{GHz}$, NPN Single PCP

ON Semiconductor®

<http://onsemi.com>

Features

- High gain : $|S_{21e}|^2=9\text{dB typ}$ ($f=1\text{GHz}$)
- High cut-off frequency : $f_T=6.7\text{GHz typ}$

Specifications

Absolute Maximum Ratings at $T_a=25^\circ\text{C}$

Parameter	Symbol	Conditions	Ratings	Unit
Collector-to-Base Voltage	V_{CBO}		20	V
Collector-to-Emitter Voltage	V_{CEO}		12	V
Emitter-to-Base Voltage	V_{EBO}		2	V
Collector Current	I_C		100	mA
Collector Dissipation	P_C	When mounted on ceramic substrate (250mm ² ×0.8mm)	800	mW
Junction Temperature	T_j		150	°C
Storage Temperature	T_{stg}		-55 to +150	°C

Stresses exceeding Maximum Ratings may damage the device. Maximum Ratings are stress ratings only. Functional operation above the Recommended Operating Conditions is not implied. Extended exposure to stresses above the Recommended Operating Conditions may affect device reliability.

Package Dimensions

unit : mm (typ)

7007B-004

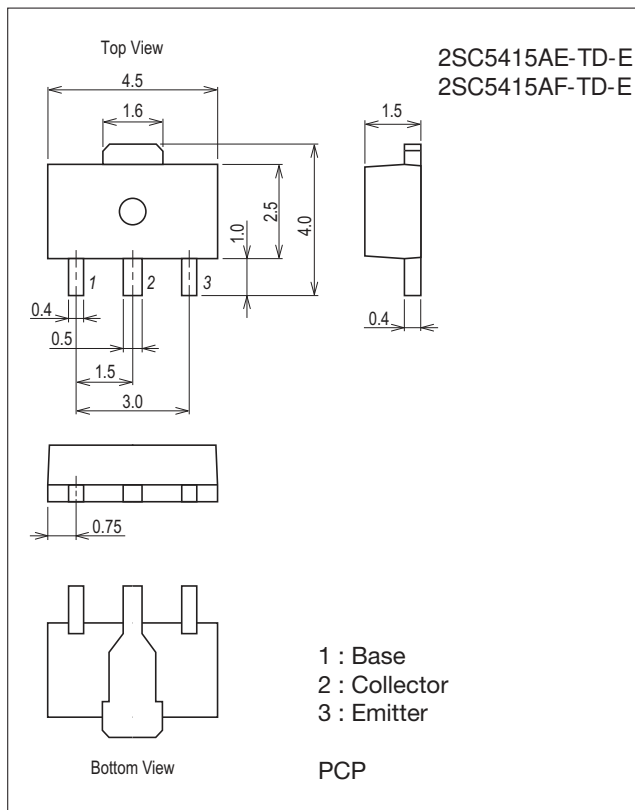

Product & Package Information

- Package : PCP
- JEITA, JEDEC : SC-62, SOT-89, TO-243
- Minimum Packing Quantity : 1,000 pcs./reel

Packing Type: TD

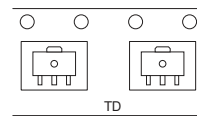

Marking

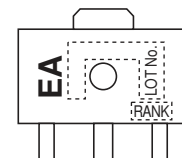

Electrical Connection

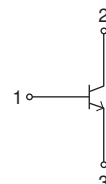

2SC5415A

Electrical Characteristics at Ta=25°C

Parameter	Symbol	Conditions	Ratings			Unit
			min	typ	max	
Collector Cutoff Current	ICBO	V _{CB} =10V, I _E =0A			1.0	μA
Emitter Cutoff Current	I _{EBO}	V _{EB} =1V, I _C =0A			10	μA
DC Current Gain	h _{FE1}	V _{CE} =5V, I _C =30mA	90*		270*	
	h _{FE2}	V _{CE} =5V, I _C =70mA	70			
Gain-Bandwidth Product	f _T	V _{CE} =5V, I _C =30mA	5	6.7		GHz
Output Capacitance	C _{ob}	V _{CB} =5V, f=1MHz		1.2	1.8	pF
Reverse Transfer Capacitance	C _{re}				0.65	
Forward Transfer Gain	S _{21e} ²	V _{CE} =5V, I _C =30mA, f=1GHz	7.5	9		dB
Noise Figure	NF	V _{CE} =5V, I _C =7mA, f=1GHz		1.1	2.0	dB

* : The 2SC5415A is classified by 30mA h_{FE} as follows :

Rank	E	F
h _{FE}	90 to 180	135 to 270

Ordering Information

Device	Package	Shipping	memo
2SC5415AE-TD-E	PCP	1,000pcs./reel	Pb Free
2SC5415AF-TD-E	PCP	1,000pcs./reel	

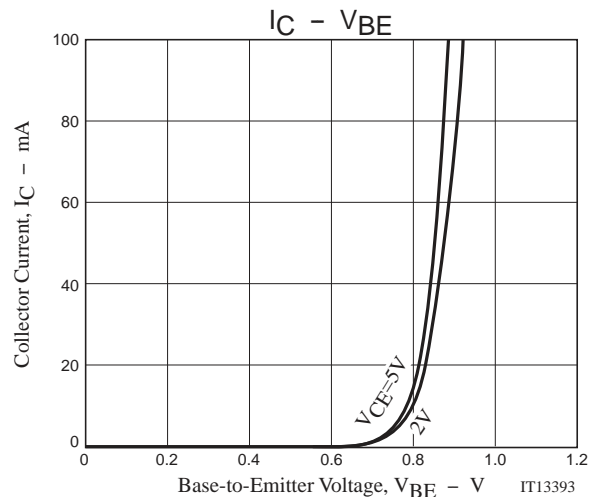
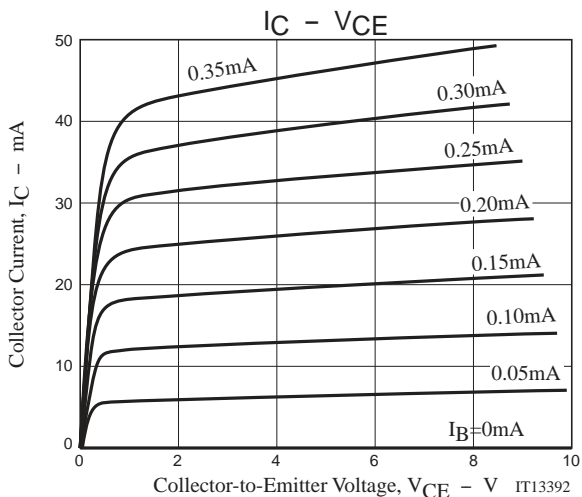

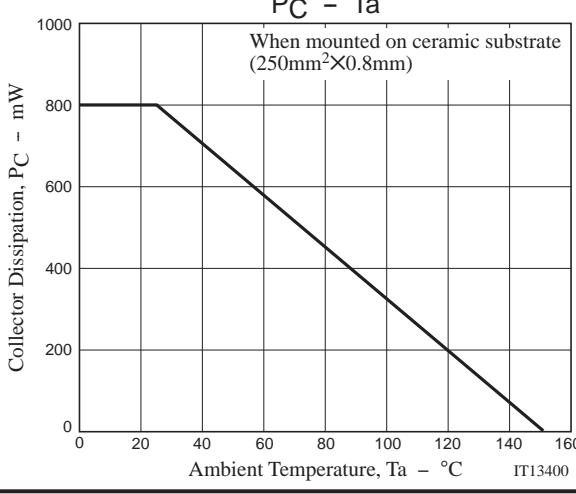
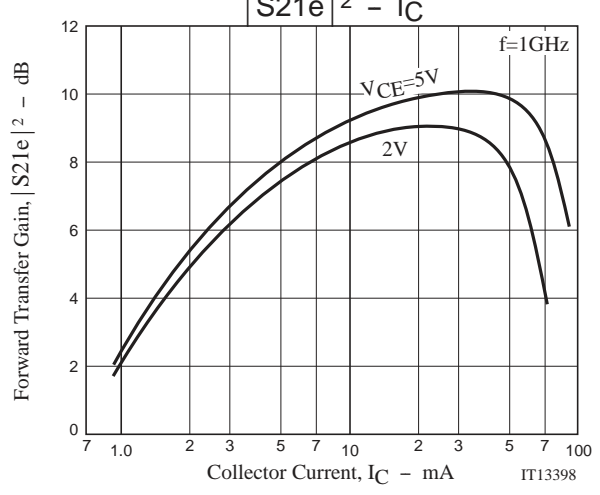
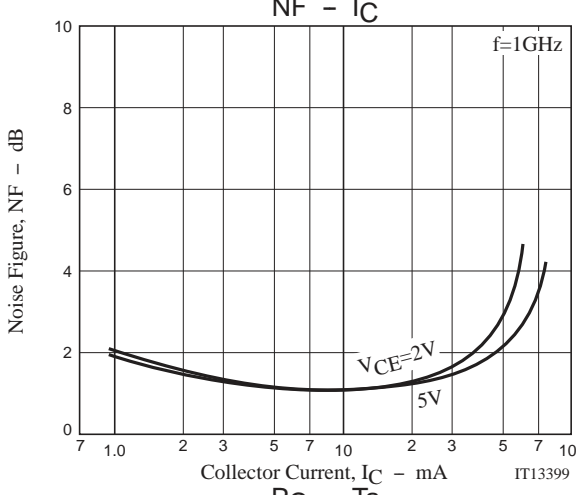
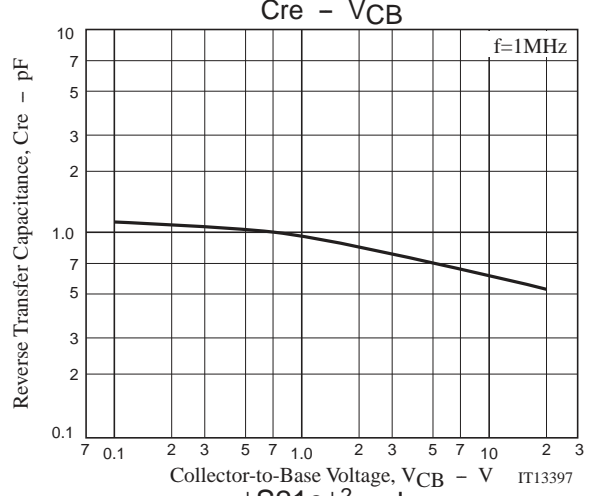
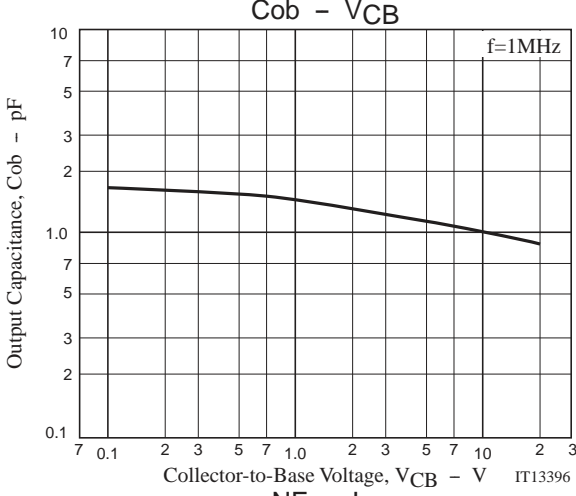
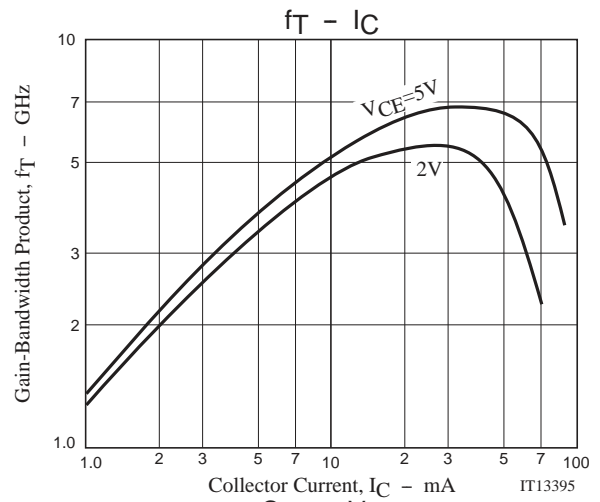
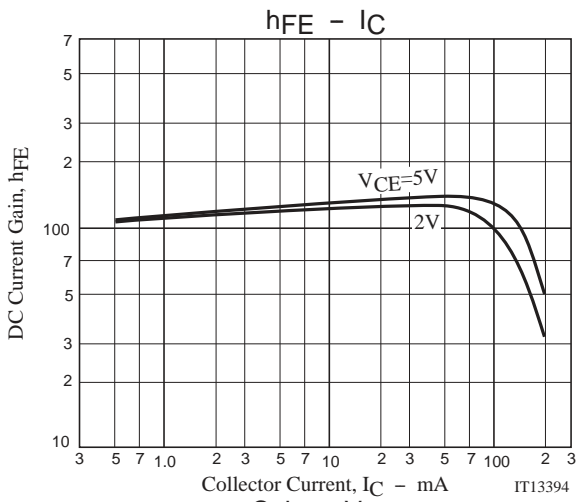

2SC5415A

S Parameters (Common emitter)

$V_{CE}=2V, I_C=5mA, Z_O=50\Omega$

Freq(MHz)	S11	$\angle S11$	S21	$\angle S21$	S12	$\angle S12$	S22	$\angle S22$
100	0.737	-51.3	11.929	142.2	0.046	65.0	0.836	-27.1
200	0.564	-86.8	8.854	118.5	0.070	54.3	0.649	-39.5
400	0.408	-129.5	5.231	95.2	0.097	51.5	0.454	-48.4
600	0.366	-155.0	3.667	82.0	0.121	53.7	0.394	-52.3
800	0.348	-175.8	2.811	70.0	0.147	55.3	0.370	-56.6
1000	0.338	169.4	2.332	62.6	0.175	56.2	0.368	-60.5
1200	0.346	156.6	2.000	54.2	0.205	55.7	0.361	-66.7
1400	0.350	145.7	1.739	47.3	0.235	54.9	0.363	-72.2
1600	0.360	136.1	1.557	40.6	0.267	53.7	0.371	-77.7
1800	0.365	126.2	1.428	34.4	0.300	51.7	0.383	-83.4
2000	0.369	116.9	1.306	29.3	0.334	49.2	0.385	-89.5

$V_{CE}=2V, I_C=10mA, Z_O=50\Omega$

Freq(MHz)	S11	$\angle S11$	S21	$\angle S21$	S12	$\angle S12$	S22	$\angle S22$
100	0.580	-67.4	17.590	130.8	0.040	62.8	0.715	-36.9
200	0.414	-104.9	11.116	109.3	0.059	58.5	0.490	-48.3
400	0.311	-145.7	6.099	90.2	0.091	60.9	0.338	-53.5
600	0.291	-168.2	4.213	79.2	0.125	62.4	0.294	-56.9
800	0.286	172.9	3.212	69.7	0.159	61.8	0.279	-61.6
1000	0.281	159.6	2.634	62.4	0.194	60.3	0.277	-65.9
1200	0.292	148.3	2.248	54.9	0.228	57.7	0.281	-71.7
1400	0.297	138.5	1.973	48.5	0.261	55.2	0.284	-77.2
1600	0.305	129.7	1.767	42.4	0.295	52.6	0.290	-82.7
1800	0.311	120.5	1.605	36.4	0.328	49.6	0.297	-88.5
2000	0.313	111.7	1.473	31.2	0.362	46.3	0.303	-93.9

$V_{CE}=2V, I_C=20mA, Z_O=50\Omega$

Freq(MHz)	S11	$\angle S11$	S21	$\angle S21$	S12	$\angle S12$	S22	$\angle S22$
100	0.432	-85.5	21.435	121.4	0.034	63.6	0.585	-45.4
200	0.313	-123.5	12.390	102.7	0.052	64.6	0.375	-54.0
400	0.263	-160.5	6.547	87.0	0.090	67.4	0.260	-57.1
600	0.257	-179.7	4.481	77.4	0.129	67.0	0.231	-60.9
800	0.260	163.3	3.408	68.8	0.168	64.8	0.224	-66.3
1000	0.258	151.6	2.792	62.1	0.206	62.3	0.224	-70.9
1200	0.271	141.6	2.378	55.1	0.243	58.7	0.231	-77.2
1400	0.270	133.1	2.085	49.1	0.278	55.4	0.236	-82.9
1600	0.282	124.5	1.867	43.2	0.313	52.2	0.242	-88.4
1800	0.288	115.4	1.697	37.5	0.346	48.7	0.249	-94.2
2000	0.290	107.0	1.558	32.3	0.380	45.0	0.256	-99.4

$V_{CE}=2V, I_C=30mA, Z_O=50\Omega$

Freq(MHz)	S11	$\angle S11$	S21	$\angle S21$	S12	$\angle S12$	S22	$\angle S22$
100	0.370	-97.4	22.555	117.0	0.031	65.1	0.518	-49.0
200	0.288	-135.1	12.614	99.9	0.051	67.4	0.326	-55.8
400	0.260	-168.5	6.590	85.5	0.090	69.9	0.229	-58.1
600	0.259	174.8	4.499	76.4	0.131	68.6	0.207	-62.3
800	0.263	159.3	3.419	68.1	0.172	66.0	0.204	-68.3
1000	0.262	148.2	2.796	61.7	0.211	62.8	0.206	-73.2
1200	0.275	138.9	2.382	54.7	0.248	59.1	0.215	-79.6
1400	0.279	130.4	2.089	48.8	0.284	55.6	0.220	-85.4
1600	0.286	122.5	1.869	43.0	0.320	52.1	0.227	-91.1
1800	0.291	113.8	1.700	37.3	0.353	48.4	0.235	-97.0
2000	0.293	105.4	1.562	32.2	0.387	44.7	0.242	-102.2

2SC5415A

S Parameters (Common emitter)

$V_{CE}=5V, I_C=5mA, Z_O=50\Omega$

Freq(MHz)	S11	$\angle S11$	S21	$\angle S21$	S12	$\angle S12$	S22	$\angle S22$
100	0.752	-45.7	12.674	144.1	0.037	67.6	0.871	-21.6
200	0.575	-78.6	9.416	121.5	0.058	57.3	0.697	-32.2
400	0.391	-119.9	5.688	97.7	0.082	54.4	0.532	-38.3
600	0.334	-146.4	4.015	84.3	0.103	56.8	0.472	-41.5
800	0.307	-169.1	3.085	73.2	0.126	58.9	0.450	-45.4
1000	0.292	174.7	2.534	65.1	0.151	60.2	0.444	-49.5
1200	0.303	160.6	2.164	56.8	0.177	60.0	0.449	-54.6
1400	0.305	148.6	1.896	499.9	0.204	59.7	0.453	-59.6
1600	0.314	137.9	1.693	43.2	0.235	58.9	0.454	-65.0
1800	0.321	127.3	1.530	36.9	0.267	57.1	0.460	-70.0
2000	0.328	117.7	1.394	31.5	0.299	55.1	0.470	-76.4

$V_{CE}=5V, I_C=10mA, Z_O=50\Omega$

Freq(MHz)	S11	$\angle S11$	S21	$\angle S21$	S12	$\angle S12$	S22	$\angle S22$
100	0.601	-58.4	18.468	133.9	0.033	65.7	0.765	-25.1
200	0.413	-92.4	12.043	112.1	0.049	61.0	0.603	-30.7
400	0.275	-132.7	6.703	92.4	0.078	63.3	0.509	-36.8
600	0.240	-157.9	4.641	81.3	0.107	64.8	0.470	-45.9
800	0.228	-179.9	3.536	71.9	0.137	64.6	0.438	-56.8
1000	0.221	164.7	2.889	64.8	0.168	63.6	0.408	-69.3
1200	0.232	151.6	2.462	57.2	0.199	61.5	0.371	-83.9
1400	0.238	140.6	2.154	51.0	0.229	59.5	0.334	-100.6
1600	0.249	131.1	1.924	44.8	0.259	57.3	0.298	-120.1
1800	0.257	120.9	1.740	38.8	0.290	54.6	0.265	-143.5
2000	0.262	111.5	1.589	33.6	0.322	51.6	0.246	-170.6

$V_{CE}=5V, I_C=30mA, Z_O=50\Omega$

Freq(MHz)	S11	$\angle S11$	S21	$\angle S21$	S12	$\angle S12$	S22	$\angle S22$
100	0.373	-79.4	24.799	120.4	0.026	67.6	0.598	-36.8
200	0.245	-114.8	14.190	102.5	0.043	69.5	0.418	-39.2
400	0.183	-154.3	7.472	87.6	0.077	71.8	0.331	-38.5
600	0.174	-175.8	5.102	78.5	0.112	70.9	0.310	-41.3
800	0.177	163.8	3.872	70.4	0.147	68.7	0.305	-46.3
1000	0.177	150.2	3.158	64.1	0.181	66.1	0.308	-51.0
1200	0.190	139.3	2.681	57.4	0.215	62.8	0.313	-57.0
1400	0.197	129.5	2.343	51.6	0.247	59.6	0.317	-62.4
1600	0.209	121.2	2.090	45.9	0.279	56.7	0.321	-67.8
1800	0.217	111.6	1.892	40.3	0.309	53.3	0.327	-73.6
2000	0.222	102.6	1.727	35.2	0.340	49.9	0.333	-78.9

$V_{CE}=5V, I_C=50mA, Z_O=50\Omega$

Freq(MHz)	S11	$\angle S11$	S21	$\angle S21$	S12	$\angle S12$	S22	$\angle S22$
100	0.308	-92.8	25.470	116.0	0.024	69.2	0.543	-36.8
200	0.221	-129.7	14.126	99.7	0.041	72.1	0.389	-36.4
400	0.190	-165.7	7.357	85.9	0.076	73.8	0.324	-35.3
600	0.189	176.0	5.012	77.4	0.111	72.5	0.309	-38.8
800	0.195	158.6	3.800	69.4	0.146	69.9	0.307	-44.2
1000	0.195	146.5	3.097	63.2	0.180	67.2	0.311	-49.3
1200	0.209	136.8	2.630	56.5	0.214	63.7	0.317	-55.6
1400	0.216	127.8	2.300	50.8	0.246	60.5	0.321	-61.3
1600	0.227	119.9	2.050	45.1	0.279	57.5	0.325	-66.9
1800	0.237	111.0	1.857	39.4	0.310	54.1	0.331	-72.8
2000	0.241	102.2	1.695	34.5	0.341	50.5	0.337	-78.3

2SC5415A

Embossed Taping Specification

2SC5415AE-TD-E, 2SC5415AF-TD-E

1. Packing Format

Package Name	Carrier Tape Type	Maximum Number of devices contained (pcs)			Packing format	
		Reel	Inner box	Outer box	Inner BOX (C-1)	Outer BOX (A-7)
PCP	PCP	1,000	4,000	24,000	4 reels contained Dimensions:mm (external) 183×72×185	6 inner boxes contained Dimensions:mm (external) 440×195×210

Reel label, Inner box label
(unit : mm)

Outer box label
It is a label at the time of factory shipments.
The form of a label may change in physical distribution process.

Packing method

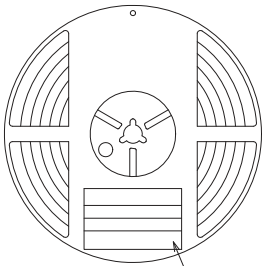

Reel label

Type No.
LOT No.
Quantity
Origin

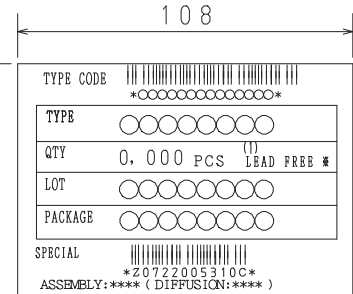
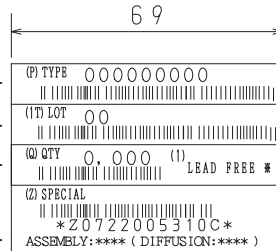

NOTE (1)

The LEAD FREE * description shows that the surface treatment of the terminal is lead free.

Label	JEITA Phase
LEAD FREE 3	JEITA Phase 3A
LEAD FREE 4	JEITA Phase 3

2. Taping configuration

2-1. Carrier tape size (unit:mm)

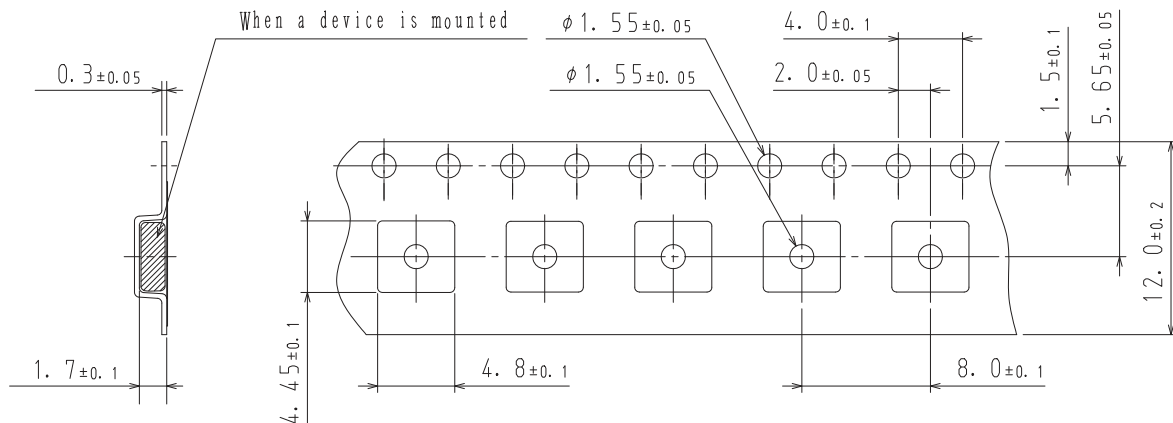

2-2. Device placement direction

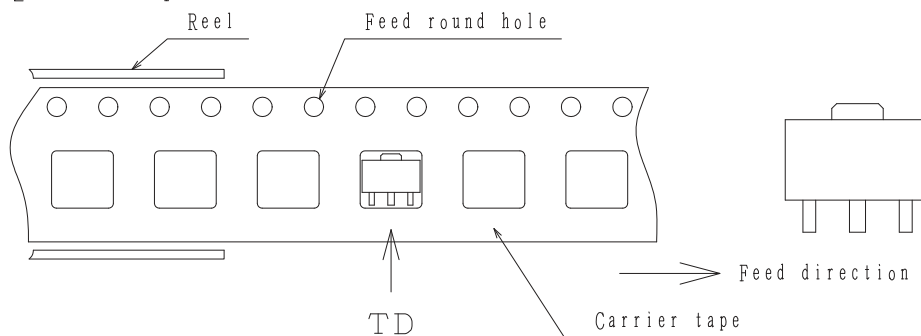

Those with pin 1 index on the feed hole side.....TD

2SC5415A

Outline Drawing

2SC5415AE-TD-E, 2SC5415AF-TD-E

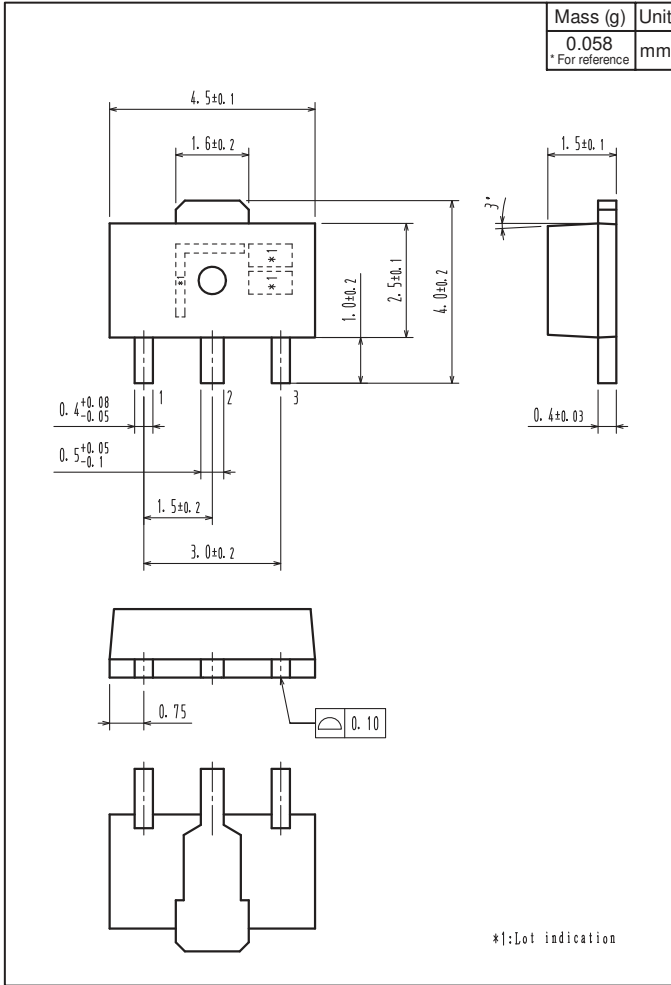

Land Pattern Example

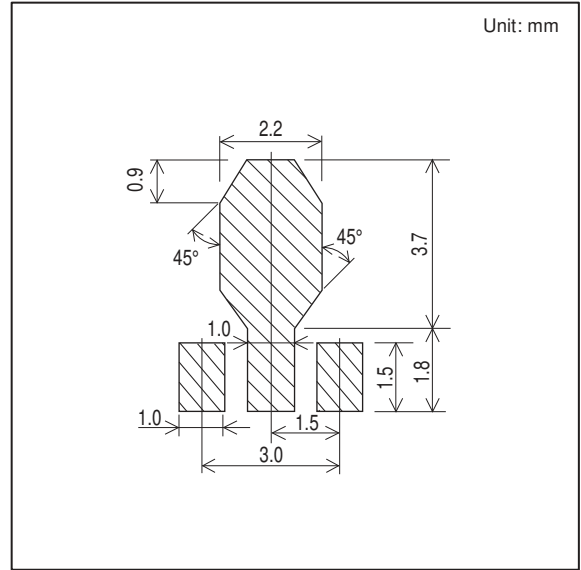

ON Semiconductor and the ON logo are registered trademarks of Semiconductor Components Industries, LLC (SCILLC). SCILLC owns the rights to a number of patents, trademarks, copyrights, trade secrets, and other intellectual property. A listing of SCILLC's product/patent coverage may be accessed at www.onsemi.com/site/pdf/Patent-Marking.pdf. SCILLC reserves the right to make changes without further notice to any products herein. SCILLC makes no warranty, representation or guarantee regarding the suitability of its products for any particular purpose, nor does SCILLC assume any liability arising out of the application or use of any product or circuit, and specifically disclaims any and all liability, including without limitation special, consequential or incidental damages. "Typical" parameters which may be provided in SCILLC data sheets and/or specifications can and do vary in different applications and actual performance may vary over time. All operating parameters, including "Typicals" must be validated for each customer application by customer's technical experts. SCILLC does not convey any license under its patent rights nor the rights of others. SCILLC products are not designed, intended, or authorized for use as components in systems intended for surgical implant into the body, or other applications intended to support or sustain life, or for any other application in which the failure of the SCILLC product could create a situation where personal injury or death may occur. Should Buyer purchase or use SCILLC products for any such unintended or unauthorized application, Buyer shall indemnify and hold SCILLC and its officers, employees, subsidiaries, affiliates, and distributors harmless against all claims, costs, damages, and expenses, and reasonable attorney fees arising out of, directly or indirectly, any claim of personal injury or death associated with such unintended or unauthorized use, even if such claim alleges that SCILLC was negligent regarding the design or manufacture of the part. SCILLC is an Equal Opportunity/Affirmative Action Employer. This literature is subject to all applicable copyright laws and is not for resale in any manner.