

10 9 8 7 6 5 4 3 2 1

番号 NO.	名称 NAME	原料 MATERIAL	数量 QTY	仕上げ FINISH
①	ウエハー WAFER	ナイロン NYLON	1	UL94V-0
②	ピン PIN	黄銅 BRASS	N	全体錫メッキ PRE-TINNED
③	フィッティングネール FITTING NAIL	黄銅 BRASS	2	錫メッキ TIN PLATING

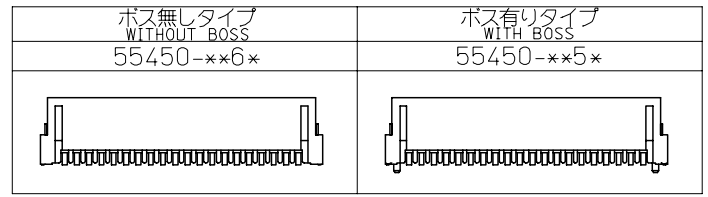

54596-***
リセプトフルアセンブリ
REC. ASS'Y

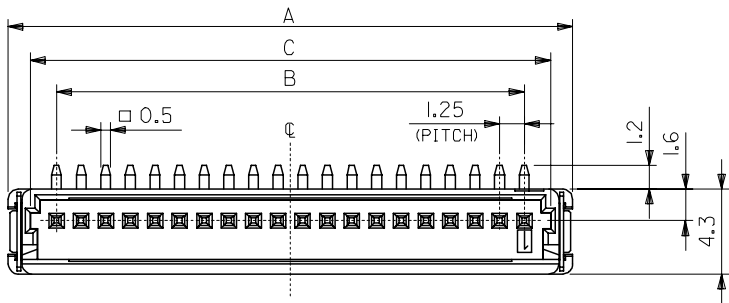
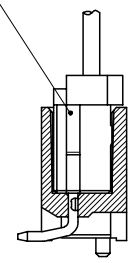

嵌合図
MATING REC.

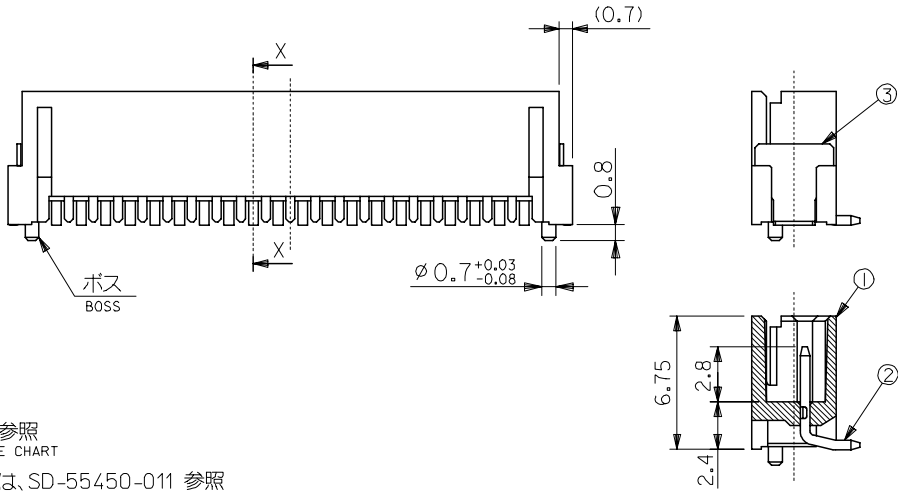

断面 X-X
SECTION X-X

27.05	26.25	26.4	23.75	28.65	20	55450-20**
25.8	25	25.15	22.5	27.4	19	-19**
24.55	23.75	23.9	21.25	26.15	18	-18**
23.3	22.5	22.65	20	24.9	17	-17**
22.05	21.25	21.4	18.75	23.65	16	-16**
20.8	20	20.15	17.5	22.4	15	-15**
19.55	18.75	18.9	16.25	21.15	14	-14**
18.3	17.5	17.65	15	19.9	13	-13**
17.05	16.25	16.4	13.75	18.65	12	-12**
15.8	15	15.15	12.5	17.4	11	-11**
14.55	13.75	13.9	11.25	16.15	10	-10**
13.3	12.5	12.65	10	14.9	9	-09**
12.05	11.25	11.4	8.75	13.65	8	-08**
10.8	10	10.15	7.5	12.4	7	-07**
9.55	8.75	8.9	6.25	11.15	6	-06**
8.3	7.5	7.65	5	9.9	5	-05**
7.05	6.25	6.4	3.75	8.65	4	-04**
5.8	5	5.15	2.5	7.4	3	-03**
4.55	3.75	3.9	1.25	6.15	2	55450-02**
E	D	C	B	A	極数 CIRCUIT SIZE	△ 製品番号 MATERIAL NO.

注) NOTES

1. 原料および仕上げ: 表参照
MATERIAL AND FINISH: SEE CHART
2. インボス梱包品の詳細は、SD-55450-011 参照
REFER TO THE SD-55450-011 FOR THE EMBOSSED PACKAGING.
3. 端子平坦度は 0.15 MA X. とする。
COPLANALITY TO BE 0.15 MAX.

△ 製品番号
MATERIAL NO.

55450-****

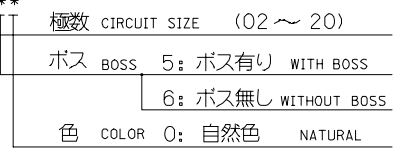

5. 本製品は 55450-**10/**30/**70/**80 の鉛フリー品である。
THIS PRODUCT IS LEAD FREE OF 55450-**10/**30/**70/**80.

REVISED EC NO: J2007-0566 DRWN: OTANI CHKD: NUKITA APPR: NUKITA	DESCRIPTION	GENERAL TOLERANCES (UNLESS SPECIFIED)		DIMENSION STYLE MM ONLY		SCALE 4:1	DESIGN UNITS METRIC	THIRD ANGLE PROJECTION	
		10 UNDER	±0.2	DRAWN BY N. AIDA	DATE '05/02/01	TITLE MINI M12 1-ROW SMT WAFER ASS'Y (TIN) -LEAD FREE-		MOLEX INCORPORATED	
10 OVER 30 UNDER	±0.25	CHECKED BY K. TOJO	DATE '05/02/01	APPROVED BY N. UKITA		DATE '05/02/01	DOCUMENT NO. SD-55450-010		
30 OVER	±0.3	ANGULAR ±3 °		MATERIAL NO. SEE CHART		SHEET NO. 1 OF 2		THIS DRAWING CONTAINS INFORMATION THAT IS PROPRIETARY TO MOLEX INCORPORATED AND SHOULD NOT BE USED WITHOUT WRITTEN PERMISSION	
DRAFT WHERE APPLICABLE MUST REMAIN WITHIN DIMENSIONS		SIZE A3		MATERIAL NO. SEE CHART		DOCUMENT NO. SD-55450-010		SHEET NO. 1 OF 2	

10

9

8

7

6

5

4

3

2

1

F

F

E

E

D

D

C

C

B

B

A

A

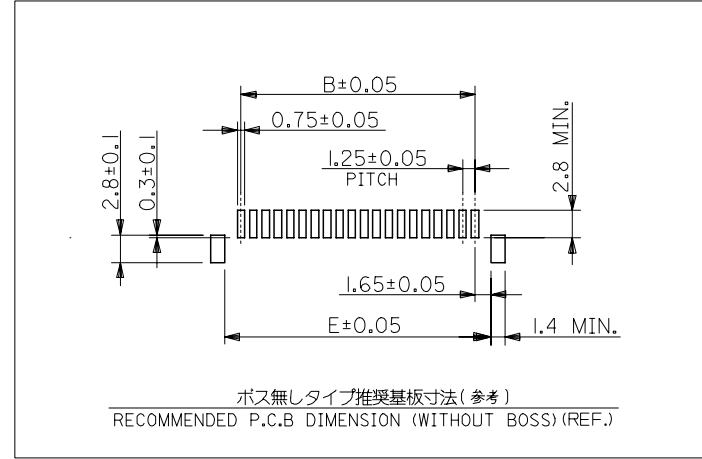
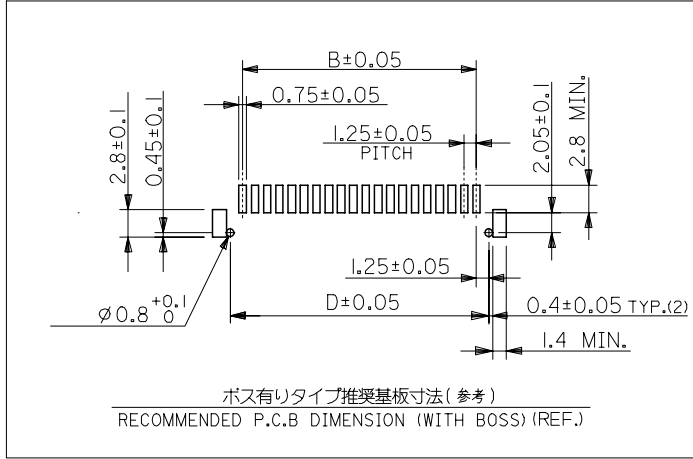

REVISED EC NO: J2007-0566 DRWN: OTANI 2006/09/01 CHK: NUKITA 2006/09/05 APPR: NUKITA 2006/09/08	GENERAL TOLERANCES (UNLESS SPECIFIED)		DIMENSION STYLE MM ONLY		SCALE 4:1	DESIGN UNITS METRIC	THIRD ANGLE PROJECTION	
	10 UNDER	±0.2	DRAWN BY N. AIDA	DATE '05/02/01	TITLE MINI M12 1-ROW SMT WAFER ASS'Y (TIN) -LEAD FREE-			
	10 OVER 30 UNDER	±0.25	CHECKED BY K. TOJO	DATE '05/02/01				
	30 OVER	±0.3	APPROVED BY N. UKITA	DATE '05/02/01	MOLEX INCORPORATED DOCUMENT NO. SD-55450-010 SHEET NO. 2 OF 2			
	ANGULAR	±3 °	MATERIAL NO. SEE CHART					
DRAFT WHERE APPLICABLE MUST REMAIN WITHIN DIMENSIONS		SIZE A3		THIS DRAWING CONTAINS INFORMATION THAT IS PROPRIETARY TO MOLEX INCORPORATED AND SHOULD NOT BE USED WITHOUT WRITTEN PERMISSION				

9

8

7

6

5

4

3

2