

HybridPACK™ DC6 module with Trench/Fieldstop IGBT3 and emitter controlled 3 diode and NTC

Features

- Electrical features
 - $V_{CES} = 700\text{ V}$
 - $I_{C\text{nom}} = 400\text{ A} / I_{CRM} = 800\text{ A}$
 - Increased blocking voltage capability to 705 V
 - $V_{CE,sat}$ with positive temperature coefficient
 - Low $V_{CE,sat}$
 - Low switching losses
 - Low inductive design
 - $T_{vj,op} = 150^\circ\text{C}$
 - Short-time extended operation temperature $T_{vj,op} = 175^\circ\text{C}$
- Mechanical features
 - 2.5 kV AC 1 minute insulation
 - Al_2O_3 substrate with low thermal resistance
 - Integrated NTC temperature sensor
 - High mechanical robustness
 - RoHS compliant



Potential applications

- (Hybrid) electrical vehicles (H)EV
- Motor drives
- Optimized for automotive applications with DC link voltages up to 450 V

Description

Infineon's HybridPACK™ 1 DC6 is a variant of the HybridPACK™ 1 power module family with increased continuous current capability and a reduced stray inductance.

Like all HybridPACK™ 1 products the HybridPACK™ 1 DC6 is an automotive qualified powermodule designed for electric vehicle applications. Designed for a 150°C junction operation temperature, with a 30 hour limited 175°C capacity the module accommodates a 3-phase Six-Pack configuration of Trench-Field-Stop IGBT3 and matching emitter controlled diodes. The HybridPACK™ 1 power module family is built on Infineon's long time experience in the development of IGBT power modules, intense research efforts of new material combinations and assembly technologies. HybridPACK™ 1 DC6 is suitable for air or liquid cooling. The copper base plate combined with high-performance ceramic substrate and Infineon's enhanced wire-bonding process provides unparalleled thermal and power cycling capability and highest reliability for mild hybrid inverter or generator applications. For a compact design the driver stage PCB can easily be soldered on top of the module. All power connections are realized with screw terminals.

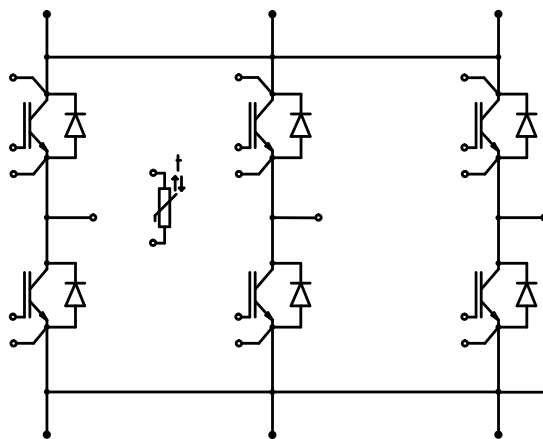

Table of contents

	Description	1
	Features	1
	Potential applications	1
	Table of contents	2
1	Package	3
2	IGBT, Inverter	3
3	Diode, Inverter	5
4	NTC-Thermistor	6
5	Characteristics diagrams	8
6	Circuit diagram	11
7	Package outlines	12
8	Module label code	13
	Revision history	14
	Disclaimer	15

1 Package

Table 1 Insulation coordination

Parameter	Symbol	Note or test condition	Values	Unit
Isolation test voltage	V_{ISOL}	RMS, $f = 50 \text{ Hz}$, $t = 1 \text{ min}$	2.5	kV
Material of module baseplate			Cu	
Internal isolation		basic insulation (class 1, IEC 61140)	Al_2O_3	
Creepage distance	d_{creep}	terminal to heatsink	12.0	mm
Creepage distance	d_{creep}	terminal to terminal	6.1	mm
Clearance	d_{clear}	terminal to heatsink	12.0	mm
Clearance	d_{clear}	terminal to terminal	6.1	mm
Comparative tracking index	CTI		>200	

Table 2 Maximum rated values

Parameter	Symbol	Note or test condition	Values	Unit
Maximum RMS module terminal current ¹⁾	$I_{t,rms}$	$T_{terminal} = 150 \text{ °C}$, $T_c = 25 \text{ °C}$	320	A

1) DC-collector current limited by internal busbar.

Table 3 Characteristic values

Parameter	Symbol	Note or test condition	Values			Unit
			Min.	Typ.	Max.	
Stray inductance module	$L_{s,CE}$			16.0		nH
Module lead resistance, terminals - chip	$R_{CC'+EE'}$	$T = 25 \text{ °C}$, per switch		1.00		mΩ
Storage temperature	T_{stg}		-40		125	°C
Mounting torque for module mounting	M	Screw M5 baseplate to heatsink	3.0		6.0	Nm
Terminal connection torque	M	Screw M6	3.0		6.0	Nm
Weight	G			510		g

Note: Mounting according to valid application note AN 2010-08 Mounting Instruction HybridPACK™ 1.

2 IGBT, Inverter

Table 4 Maximum rated values

Parameter	Symbol	Note or test condition	Values	Unit
Collector-emitter voltage	V_{CES}	$T_{vj} = 25 \text{ °C}$	705	V

(table continues...)

Table 4 (continued) Maximum rated values

Parameter	Symbol	Note or test condition	Values	Unit
Continuous DC collector current	$I_{C,nom}$	$T_c = 65\text{ °C}, T_{vj,max} = 175\text{ °C}$	400	A
Continuous DC collector current	I_C	$T_c = 25\text{ °C}, T_{vj,max} = 175\text{ °C}$	500	A
Repetitive peak collector current	I_{CRM}	$t_p = 1\text{ ms}$	800	A
Total power dissipation	P_{tot}	$T_c = 25\text{ °C}, T_{vj,max} = 175\text{ °C}$	1250	W
Gate-emitter peak voltage	V_{GES}		±20	V

Table 5 Characteristic values

Parameter	Symbol	Note or test condition	Values			Unit	
			Min.	Typ.	Max.		
Collector-emitter saturation voltage	$V_{CE,sat}$	$I_C = 400\text{ A}, V_{GE} = 15\text{ V}$	$T_{vj} = 25\text{ °C}$	1.45	1.70	V	
			$T_{vj} = 125\text{ °C}$	1.60			
			$T_{vj} = 150\text{ °C}$	1.70			
Gate threshold voltage	$V_{GE,th}$	$I_C = 6.4\text{ mA}, V_{CE} = V_{GE}$	$T_{vj} = 25\text{ °C}$	4.9	5.8	6.5	V
Gate charge	Q_G	$V_{GE} = \pm 15\text{ V}$		4.3			μC
Internal gate resistor	$R_{G,int}$		$T_{vj} = 25\text{ °C}$	1.0			Ω
Input capacitance	C_{ies}	$f = 1\text{ MHz}, V_{CE} = 25\text{ V}, V_{GE} = 0\text{ V}$	$T_{vj} = 25\text{ °C}$	26.0			nF
Reverse transfer capacitance	C_{res}	$f = 1\text{ MHz}, V_{CE} = 25\text{ V}, V_{GE} = 0\text{ V}$	$T_{vj} = 25\text{ °C}$	0.76			nF
Collector-emitter cut-off current	I_{CES}	$V_{CE} = 450\text{ V}, V_{GE} = 0\text{ V}$	$T_{vj} = 25\text{ °C}$			0.1	mA
Gate-emitter leakage current	I_{GES}	$V_{CE} = 0\text{ V}, V_{GE} = 20\text{ V}$	$T_{vj} = 25\text{ °C}$			400	nA
Turn-on delay time, inductive load	$t_{d,on}$	$I_C = 400\text{ A}, V_{CE} = 300\text{ V}, V_{GE} = \pm 15\text{ V}, R_{G,on} = 1.8\text{ } \Omega$	$T_{vj} = 25\text{ °C}$	0.12			μs
			$T_{vj} = 125\text{ °C}$	0.12			
			$T_{vj} = 150\text{ °C}$	0.12			
Rise time, inductive load	t_r	$I_C = 400\text{ A}, V_{CE} = 300\text{ V}, V_{GE} = \pm 15\text{ V}, R_{G,on} = 1.8\text{ } \Omega$	$T_{vj} = 25\text{ °C}$	0.08			μs
			$T_{vj} = 125\text{ °C}$	0.08			
			$T_{vj} = 150\text{ °C}$	0.08			
Turn-off delay time, inductive load	$t_{d,off}$	$I_C = 400\text{ A}, V_{CE} = 300\text{ V}, V_{GE} = \pm 15\text{ V}, R_{G,off} = 1.8\text{ } \Omega$	$T_{vj} = 25\text{ °C}$	0.36			μs
			$T_{vj} = 125\text{ °C}$	0.40			
			$T_{vj} = 150\text{ °C}$	0.40			

(table continues...)

Table 5 (continued) Characteristic values

Parameter	Symbol	Note or test condition	Values			Unit
			Min.	Typ.	Max.	
Fall time, inductive load	t_f	$I_C = 400\text{ A}, V_{CE} = 300\text{ V}, V_{GE} = \pm 15\text{ V}, R_{G,off} = 1.8\ \Omega$	$T_{vj} = 25\text{ °C}$	0.02		μs
			$T_{vj} = 125\text{ °C}$	0.03		
			$T_{vj} = 150\text{ °C}$	0.03		
Turn-on energy loss per pulse	E_{on}	$I_C = 400\text{ A}, V_{CE} = 300\text{ V}, L_\sigma = 16\text{ nH}, V_{GE} = \pm 15\text{ V}, R_{G,on} = 1.8\ \Omega$	$T_{vj} = 25\text{ °C}$	5.1		mJ
			$T_{vj} = 125\text{ °C}$	6.8		
			$T_{vj} = 150\text{ °C}, di/dt = 4500\text{ A}/\mu\text{s}$	7.3		
Turn-off energy loss per pulse	E_{off}	$I_C = 400\text{ A}, V_{CE} = 300\text{ V}, L_\sigma = 16\text{ nH}, V_{GE} = \pm 15\text{ V}, R_{G,off} = 1.8\ \Omega$	$T_{vj} = 25\text{ °C}$	9.1		mJ
			$T_{vj} = 125\text{ °C}$	12.0		
			$T_{vj} = 150\text{ °C}, du/dt = 3400\text{ V}/\mu\text{s}$	12.5		
SC data	I_{SC}	$V_{CC} = 360\text{ V}, V_{CEmax} = V_{CES} - L_{SCE} \cdot di/dt$	$T_{vj} = 25\text{ °C}, t_p \leq 8\ \mu\text{s}$	2800		A
			$T_{vj} = 150\text{ °C}, t_p \leq 6\ \mu\text{s}$	2000		
Thermal resistance, junction to case	$R_{th,j-c}$	per IGBT			0.120	K/W
Thermal resistance, case to heat sink	$R_{th,c-h}$	per IGBT $\lambda_{paste} = 1\text{ W}/(\text{m}\cdot\text{K}) / \lambda_{grease} = 1\text{ W}/(\text{m}\cdot\text{K})$		0.080		K/W
Temperature under switching conditions	$T_{vj,op}$	t_{op} continuous	-40		150	°C
		$t_{op,max}$ 30h over life time, for 10s within period of 10min	150		175	

Note: DC-collector current limited by power terminals.

3 Diode, Inverter

Table 6 Maximum rated values

Parameter	Symbol	Note or test condition	Values	Unit
Repetitive peak reverse voltage	V_{RRM}	$T_{vj} = 25\text{ °C}$	705	V
Continuous DC forward current	$I_{F,nom}$		400	A
Repetitive peak forward current	I_{FRM}	$t_p = 1\text{ ms}$	800	A

(table continues...)

Table 6 (continued) Maximum rated values

Parameter	Symbol	Note or test condition	Values	Unit	
I ² t - value	I ² t	V _R = 0 V, t _p = 10 ms	T _{vj} = 125 °C	8800	A ² s
			T _{vj} = 150 °C	8500	

Table 7 Characteristic values

Parameter	Symbol	Note or test condition	Values			Unit	
			Min.	Typ.	Max.		
Forward voltage	V _F	I _F = 400 A, V _{GE} = 0 V	T _{vj} = 25 °C		1.55	1.95	V
			T _{vj} = 125 °C		1.50		
			T _{vj} = 150 °C		1.45		
Peak reverse recovery current	I _{rm}	I _F = 400 A, V _{GE} = -15 V, V _R = 300 V	T _{vj} = 25 °C		205		A
			T _{vj} = 125 °C		295		
			T _{vj} = 150 °C, -di _F /dt = 4500 A/μs		305		
Recovered charge	Q _r	I _F = 400 A, V _{GE} = -15 V, V _R = 300 V	T _{vj} = 25 °C		15.0		μC
			T _{vj} = 125 °C		32.0		
			T _{vj} = 150 °C, -di _F /dt = 4500 A/μs		34.0		
Reverse recovery energy	E _{rec}	I _F = 400 A, V _{GE} = -15 V, V _R = 300 V	T _{vj} = 25 °C		3.35		mJ
			T _{vj} = 125 °C		6.90		
			T _{vj} = 150 °C, -di _F /dt = 4500 A/μs		8.10		
Thermal resistance, junction to case	R _{th,j-c}	per diode			0.200	K/W	
Thermal resistance, case to heat sink	R _{th,c-h}	per diode λ _{Paste} = 1 W/(m·K) / λ _{grease} = 1 W/(m·K)		0.085		K/W	
Temperature under switching conditions	T _{vj,op}	t _{op} continuous	-40		150	°C	
		t _{op,max} 30h over life time, for 10s within period of 10min	150		175		

Note: Diode forward current limited by power terminals.

4 NTC-Thermistor

Table 8 Characteristic values

Parameter	Symbol	Note or test condition	Values			Unit
			Min.	Typ.	Max.	
Rated resistance	R ₂₅	T _{NTC} = 25 °C		5		kΩ

(table continues...)

Table 8 (continued) **Characteristic values**

Parameter	Symbol	Note or test condition	Values			Unit
			Min.	Typ.	Max.	
Deviation of R_{100}	$\Delta R/R$	$T_{NTC} = 100\text{ °C}$, $R_{100} = 493\ \Omega$	-5		5	%
Power dissipation	P_{25}	$T_{NTC} = 25\text{ °C}$			20	mW
B-value	$B_{25/50}$	$R_2 = R_{25} \exp[B_{25/50}(1/T_2 - 1/(298,15\text{ K}))]$		3375		K
B-value	$B_{25/80}$	$R_2 = R_{25} \exp[B_{25/80}(1/T_2 - 1/(298,15\text{ K}))]$		3411		K
B-value	$B_{25/100}$	$R_2 = R_{25} \exp[B_{25/100}(1/T_2 - 1/(298,15\text{ K}))]$		3433		K

Note: Specification according to the valid application note.

5 Characteristics diagrams

Output characteristic (typical), IGBT, Inverter

$$I_C = f(V_{CE})$$

$$V_{GE} = 15 \text{ V}$$

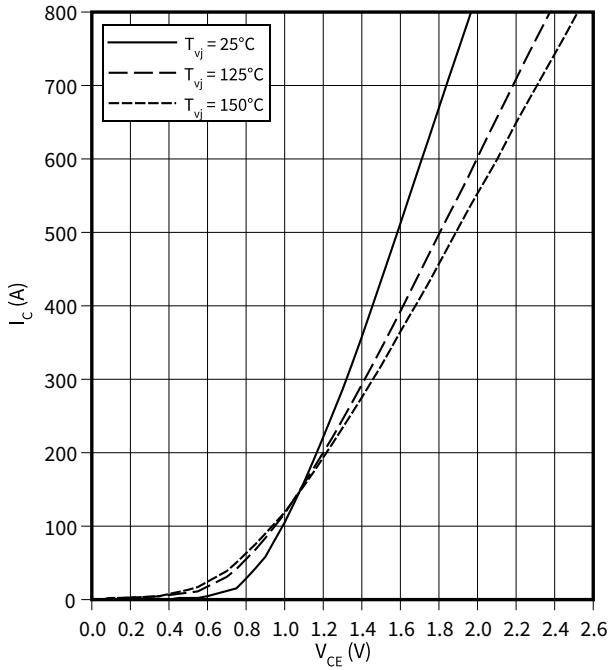

Output characteristic (typical), IGBT, Inverter

$$I_C = f(V_{CE})$$

$$T_{vj} = 150 \text{ °C}$$

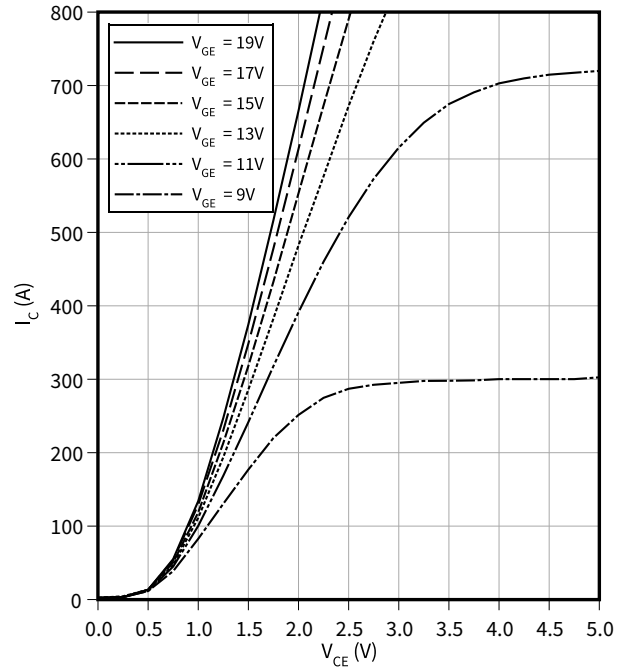

Transfer characteristic (typical), IGBT, Inverter

$$I_C = f(V_{GE})$$

$$V_{CE} = 20 \text{ V}$$

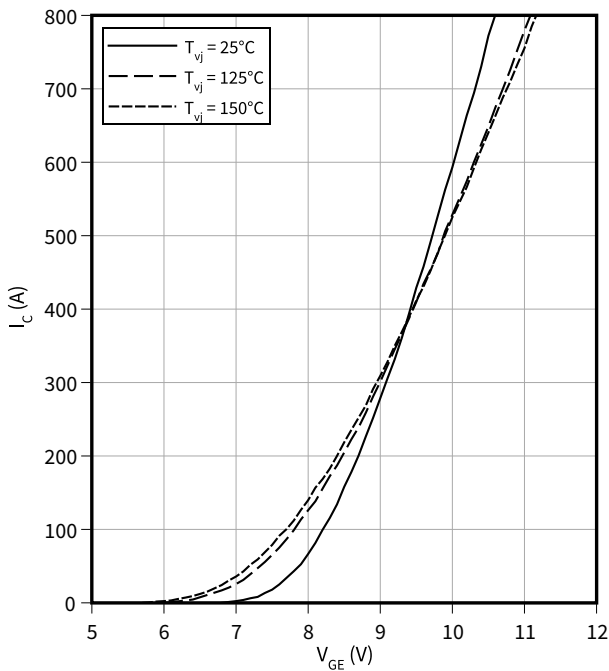

Switching losses (typical), IGBT, Inverter

$$E = f(I_C)$$

$$R_{G,off} = 1.8 \text{ } \Omega, R_{G,on} = 1.8 \text{ } \Omega, V_{CE} = 300 \text{ V}, V_{GE} = \pm 15 \text{ V}$$

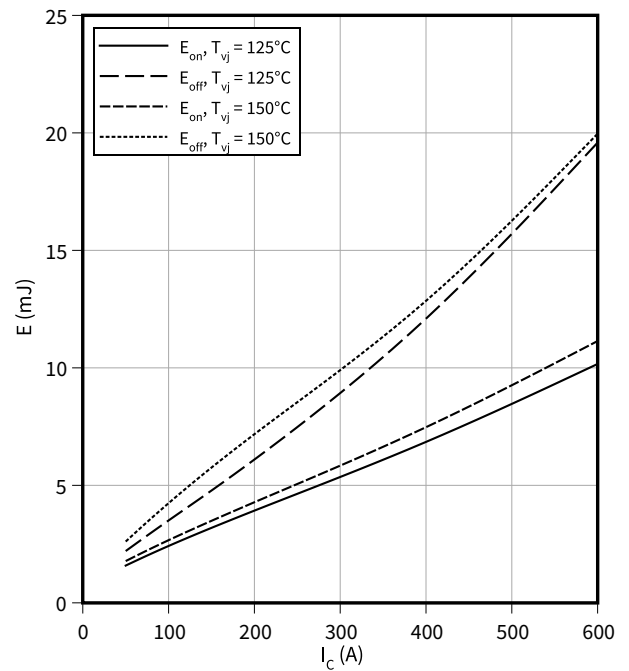

5 Characteristics diagrams

Switching losses (typical), IGBT, Inverter

$E = f(R_G)$

$V_{CE} = 300\text{ V}$, $V_{GE} = \pm 15\text{ V}$, $I_C = 400\text{ A}$

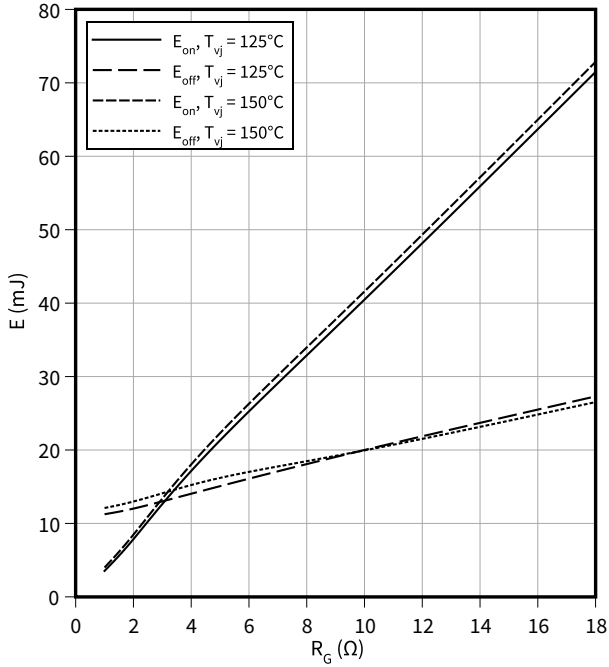

Transient thermal impedance, IGBT, Inverter

$Z_{th} = f(t)$

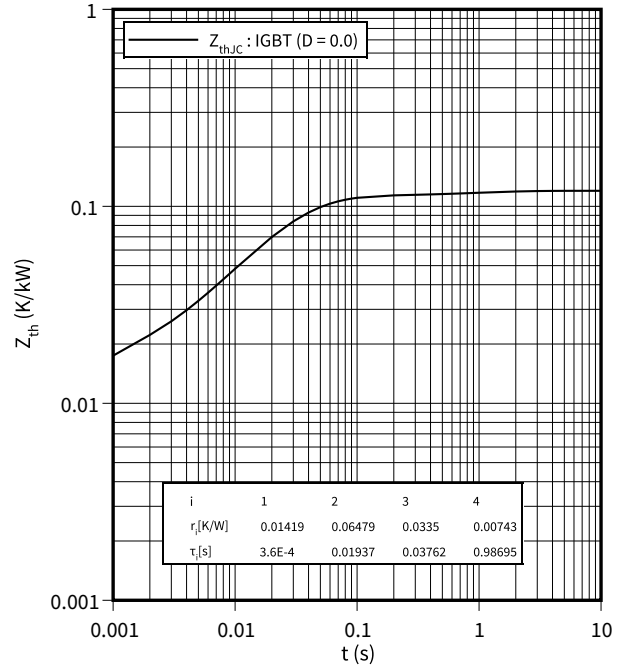

Reverse bias safe operating area (RBSOA), IGBT, Inverter

$I_C = f(V_{CE})$

$T_{vj} = 150\text{ °C}$, $R_{G,off} = 1.8\text{ Ω}$, $V_{GE} = \pm 15\text{ V}$

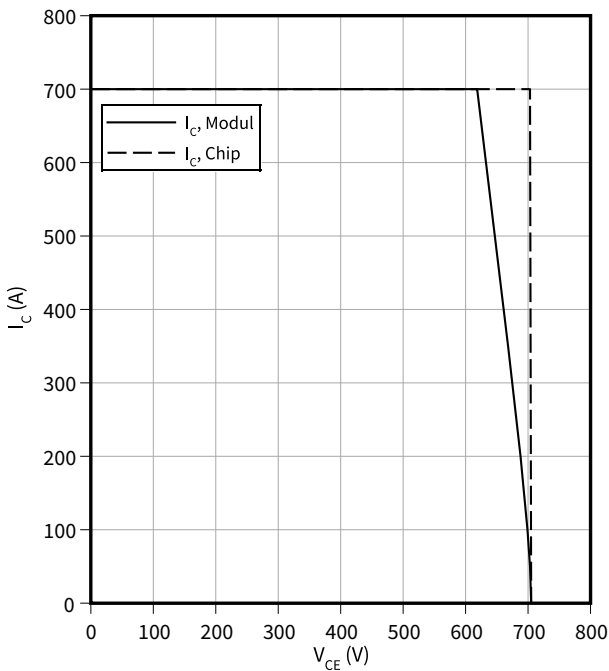

Switching losses (typical), Diode, Inverter

$E_{rec} = f(I_F)$

$R_{Gon} = 1.8\text{ Ω}$, $V_{CE} = 300\text{ V}$

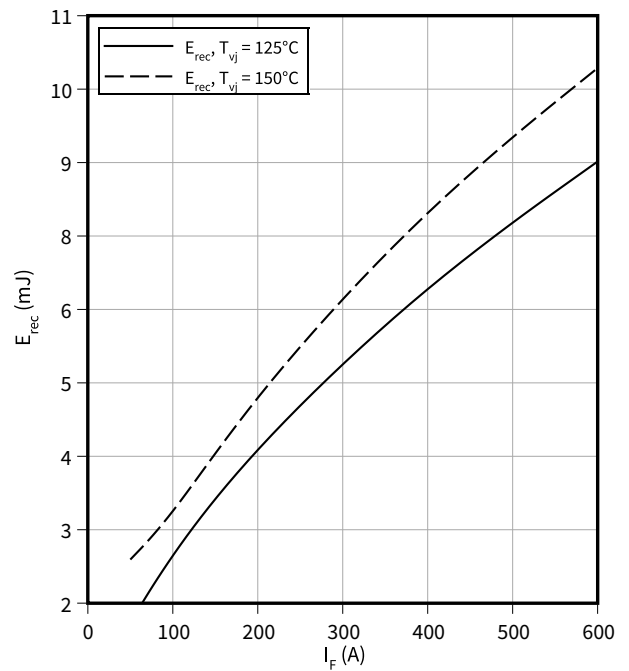

5 Characteristics diagrams

Forward characteristic (typical), Diode, Inverter

$I_F = f(V_F)$

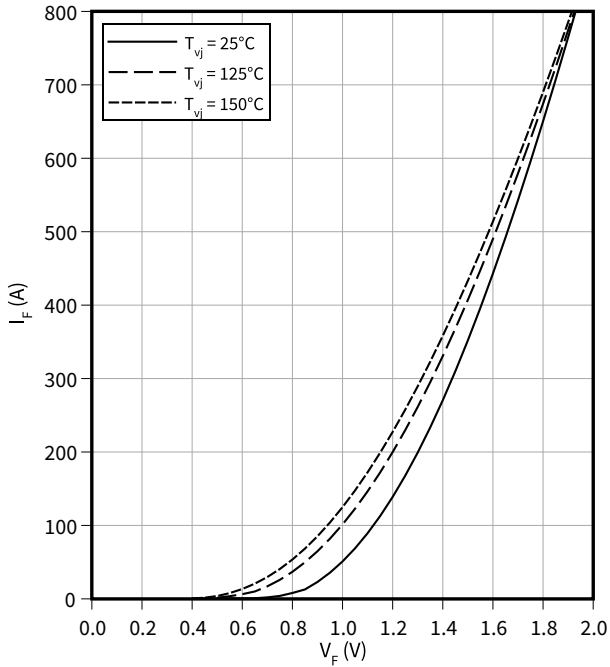

Switching losses (typical), Diode, Inverter

$E_{rec} = f(R_G)$

$V_{CE} = 300\text{ V}, I_F = 400\text{ A}$

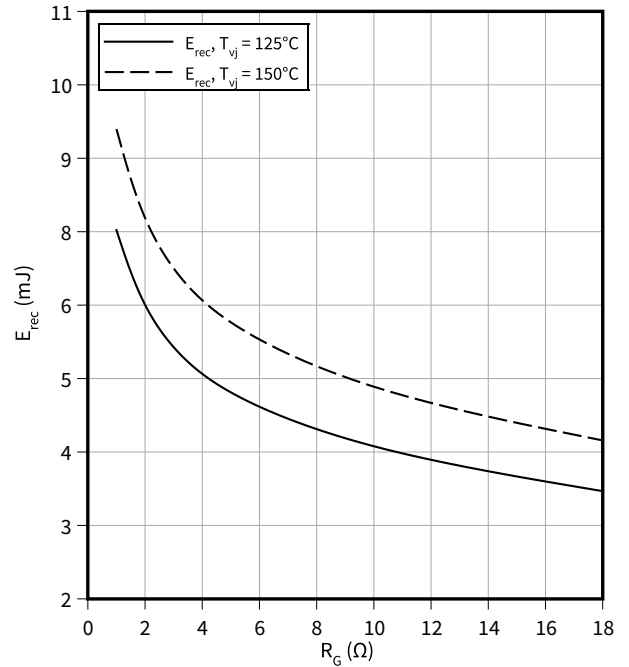

Transient thermal impedance, Diode, Inverter

$Z_{th} = f(t)$

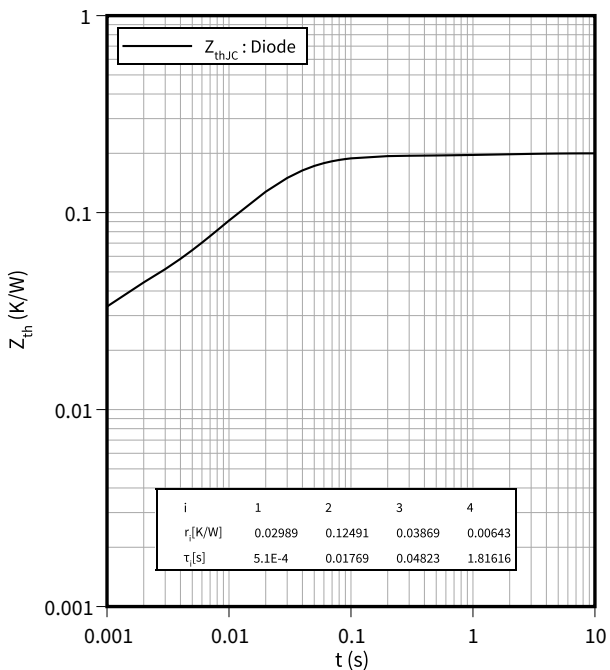

Temperature characteristic (typical), NTC-Thermistor

$R = f(T_{NTC})$

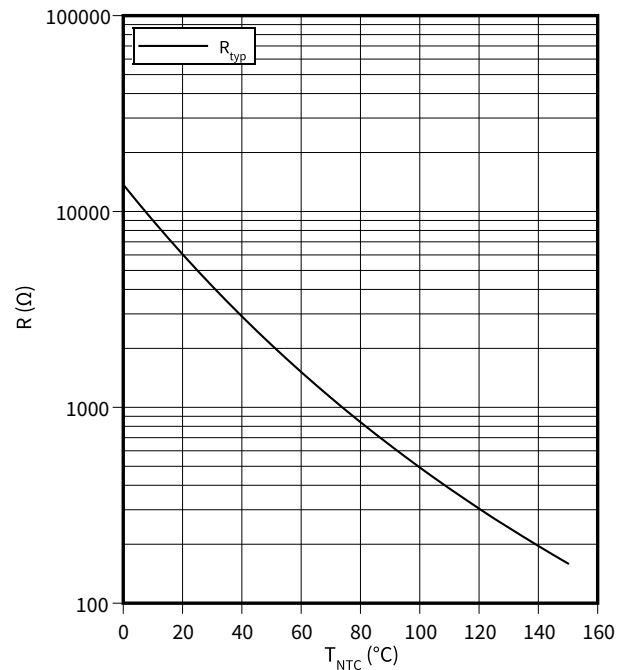

6 Circuit diagram

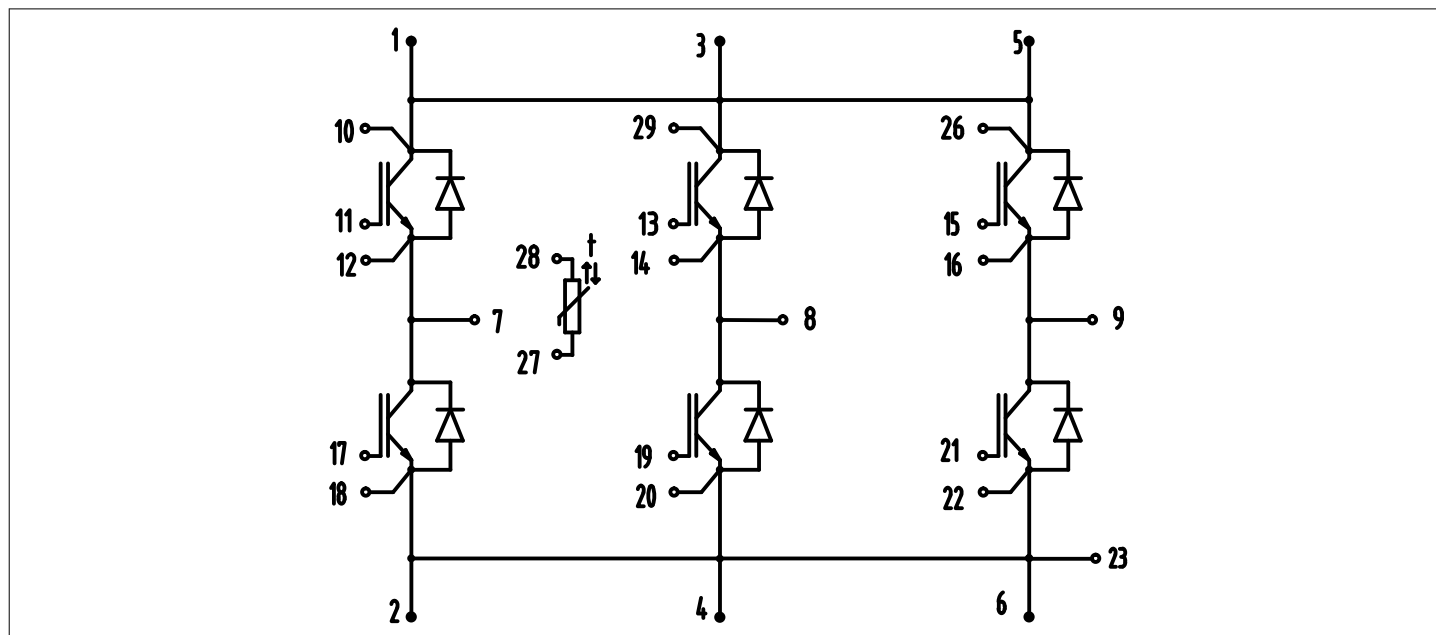

Figure 1

8 Module label code



Module label code				
Code format	Data Matrix	Barcode Code128		
Encoding	ASCII text	Code Set A		
Symbol size	16x16	23 digits		
Standard	IEC24720 and IEC16022	IEC8859-1		
Code content	<i>Content</i>	<i>Digit</i>	<i>Example</i>	
	Module serial number	1 - 5	71549	
	Module material number	6 - 11	142846	
	Production order number	12 - 19	55054991	
	Date code (production year)	20 - 21	15	
	Date code (production week)	22 - 23	30	
Example				
	71549142846550549911530		71549142846550549911530	
Packing label code				
Code format	Barcode Code128			
Encoding	Code Set A			
Symbol size	34 digits			
Standard	IEC8859-1			
Code content	<i>Content</i>	<i>Identifier</i>	<i>Digit</i>	<i>Example</i>
	Module serial number	X	2 - 9	95056609
	Module material number	1T	12 - 19	2X0003E0
	Production order number	S	21 - 25	754389
	Date code (production year)	9D	28 - 31	1139
	Date code (production week)	Q	33 - 34	15
Example				
	X950566091T2X0003E0S754389D1139Q15			

Figure 3

Revision history

Document revision	Date of release	Description of changes
V1.0	2015-04-24	
V2.0	2015-11-09	
V3.0	2017-03-07	
n/a	2020-10-05	Datasheet migrated to a new system with a new layout and new revision number schema: target or preliminary datasheet = 0.xy; final datasheet = 1.xy
1.10	2021-12-21	Adjustment of package outline

Trademarks

All referenced product or service names and trademarks are the property of their respective owners.

Edition 2021-12-21

Published by

Infineon Technologies AG

81726 Munich, Germany

© 2021 Infineon Technologies AG

All Rights Reserved.

Do you have a question about any aspect of this document?

Email: erratum@infineon.com

Document reference

IFX-AAD144-004

IMPORTANT NOTICE

The information given in this document shall in no event be regarded as a guarantee of conditions or characteristics ("Beschaffheitsgarantie").

With respect to any examples, hints or any typical values stated herein and/or any information regarding the application of the product, Infineon Technologies hereby disclaims any and all warranties and liabilities of any kind, including without limitation warranties of non-infringement of intellectual property rights of any third party.

In addition, any information given in this document is subject to customer's compliance with its obligations stated in this document and any applicable legal requirements, norms and standards concerning customer's products and any use of the product of Infineon Technologies in customer's applications.

The data contained in this document is exclusively intended for technically trained staff. It is the responsibility of customer's technical departments to evaluate the suitability of the product for the intended application and the completeness of the product information given in this document with respect to such application.

WARNINGS

Due to technical requirements products may contain dangerous substances. For information on the types in question please contact your nearest Infineon Technologies office.

Except as otherwise explicitly approved by Infineon Technologies in a written document signed by authorized representatives of Infineon Technologies, Infineon Technologies' products may not be used in any applications where a failure of the product or any consequences of the use thereof can reasonably be expected to result in personal injury.