

75 Ω , 8 V RF Amplifier

45 - 1218 MHz



MAAM-011182

Rev. V4

Features

- Single Stage, Single Ended, 8 V, 130 mA
- 18 dB Flat Gain
- Low Noise
- Low Distortion Performance
- Lead-Free 2 mm 8-lead PDFN Plastic Package
- RoHS* Compliant

Applications

- CATV

Description

The MAAM-011182 is an RF amplifier assembled in a 2 mm 8-lead PDFN plastic package. This amplifier provides 18 dB of ultra flat gain while biased at 8 volts. The amplifier provides excellent linearity.

The MAAM-011182 provides high gain, low noise and low distortion making it ideally suited for 75 Ω infrastructure applications.

The MAAM-011182 is fabricated using GaAs pHEMT technology.

Ordering Information^{1,2}

Part Number	Package
MAAM-011182	Bulk Packaging
MAAM-011182-TR1000	1000 Part Reel
MAAM-011182-TR3000	3000 Part Reel
MAAM-011182-001SMB	Sample Board

1. Reference Application Note M513 for reel size information.
2. All sample boards include 5 loose parts.

Functional Schematic

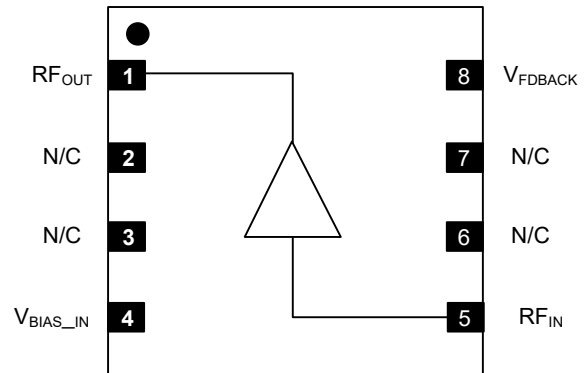

Pin Configuration³

Pin #	Pin Name	Function
1	RF _{OUT}	RF Output (75 Ω)
2,3,6,7	N/C	No Connection
4	V _{BIAS_IN}	Regulator Bias Input
5	RF _{IN}	RF Input (75 Ω)
8	V _{FDBACK}	Feedback Path
9	Pad ³	RF and DC Ground

3. The exposed pad centered on the package bottom must be connected to RF and DC ground.

* Restrictions on Hazardous Substances, compliant to current RoHS EU directive.

75 Ω , 8 V RF Amplifier

45 - 1218 MHz



MAAM-011182

Rev. V4

Electrical Specifications: Freq. = 50 - 1218 MHz, $T_A = 25^\circ\text{C}$, $V_{DD} = 8\text{ V}$, $Z_0 = 75\ \Omega$

Parameter	Test Conditions	Units	Min.	Typ.	Max.
Gain	1218 MHz	dB	18	18.5	19
Tilt	—	dB	0	0.3	1
Reverse Isolation	—	dB	—	21.5	—
Input Return Loss	—	dB	—	20	—
Output Return Loss	—	dB	—	19	—
Noise Figure	50 - 100 MHz 100 - 1218 MHz	dB	— —	2.7 2.5	3.8 3.0
Output IP2	50 - 1200 MHz, tone spacing 6 MHz, P_{OUT} per tone = -10 dBm	dBm	—	66	—
Output IP3	50 - 1200 MHz, tone spacing 6 MHz, P_{OUT} per tone = -10 dBm	dBm	—	38	—
P1dB	—	dBm	—	24	—
Composite Triple Beat, CTB	79 channels, 0 dB Tilt, 34 dBmV per channel output QAM to 1200 MHz	dBc	—	76	-74
Composite Second Order, CSO	79 channels, 0 dB Tilt, 34 dBmV per channel output QAM to 1200 MHz	dBc	—	68	-66
I_{DD}	$V_{DD} = 8\text{ V}$	mA	125	130	135

Absolute Maximum Ratings^{4,5,6,7}

Parameter	Absolute Maximum
Input Power	12 dBm
Operating Voltage	10 volts
Operating Temperature	-40°C to +85°C
Storage Temperature	-65°C to +150°C

4. Exceeding any one or combination of these limits may cause permanent damage to this device.
5. MACOM does not recommend sustained operation near these survivability limits.
6. These operating conditions will ensure MTTF > 1×10^6 hours.
7. Junction Temperature (T_J) = Case Temperature (T_C) + $\Theta_{JC} \cdot (V \cdot I)$
Typical thermal resistance (Θ_{JC}) = 43.3°C/W.
 - a) For $T_C = 25^\circ\text{C}$,
 $T_J = 71.7^\circ\text{C}$ @ 8 V, 135 mA
 - b) For $T_C = 85^\circ\text{C}$,
 $T_J = 131.7^\circ\text{C}$ @ 8 V, 135 mA

Handling Procedures

Please observe the following precautions to avoid damage:

Static Sensitivity

These electronic devices are sensitive to electrostatic discharge (ESD) and can be damaged by static electricity. Proper ESD control techniques should be used when handling these HBM Class1A, CDM Class IV devices.

75 Ω , 8 V RF Amplifier 45 - 1218 MHz



MAAM-011182

Rev. V4

Schematic Including Off-Chip Components

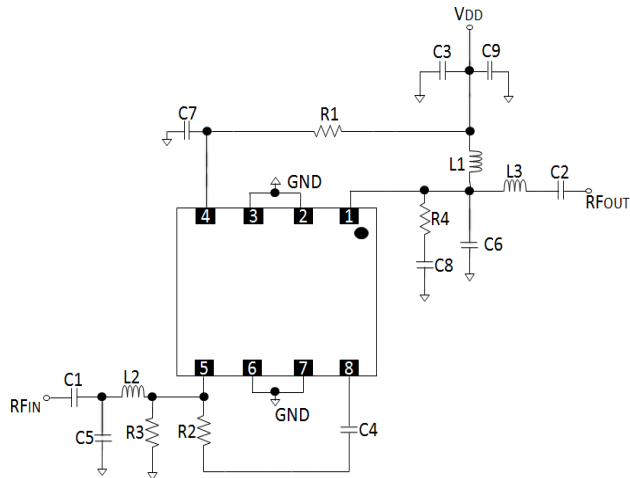

Parts List⁸

Component	Value	Package
C1,C4,C7	10 nF	0402
C2	150 pF	0402
C3	100 nF	0402
C5	0.9 pF	0402
C6	0.4 pF	0402
C8	0.6 pF	0402
C9	1 μ F	0603
L1	Ferrite Bead	0402
L2	10 nH	0402
L3	5.6 nH	0402
R1	1.6 k Ω	0402
R2	360 Ω	0402
R3	910 Ω	0402
R4	300 Ω	0402

8. Ferrite Bead from Murata, part number BLM15HD182SN.

Recommended PCB Layout

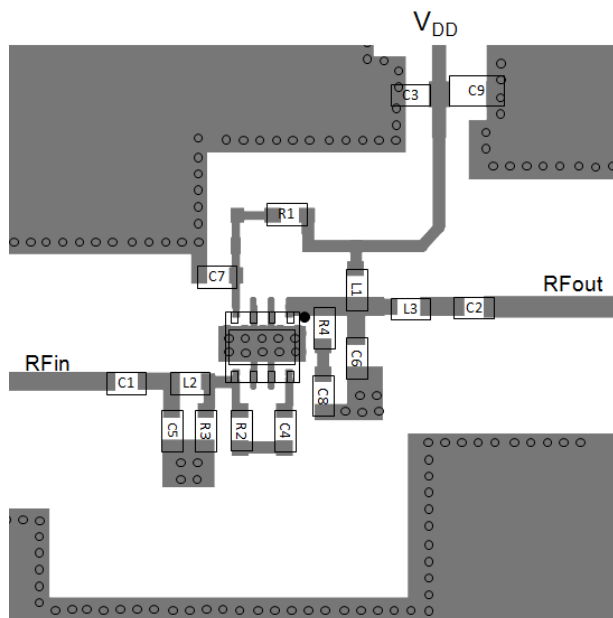

PCB Land Pattern

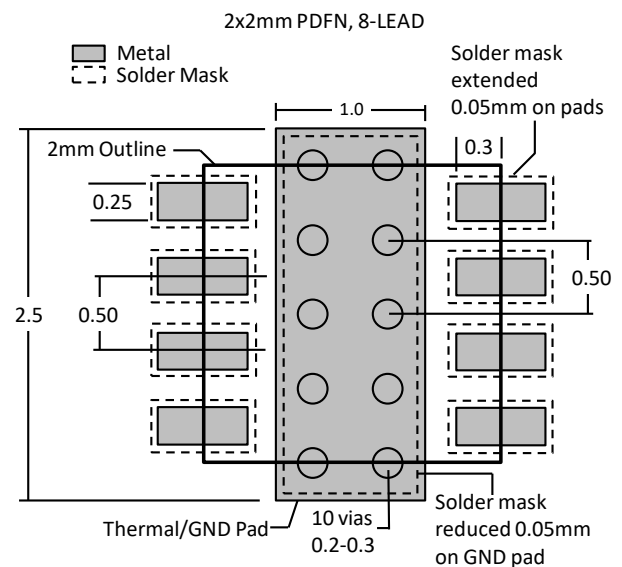

Typical Performance Curves: $V_{DD} = 8\text{ V}$

Gain to 1.218 GHz

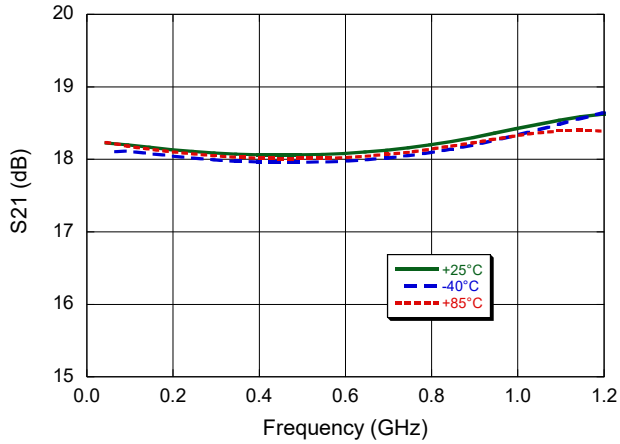

Gain to 2.5 GHz

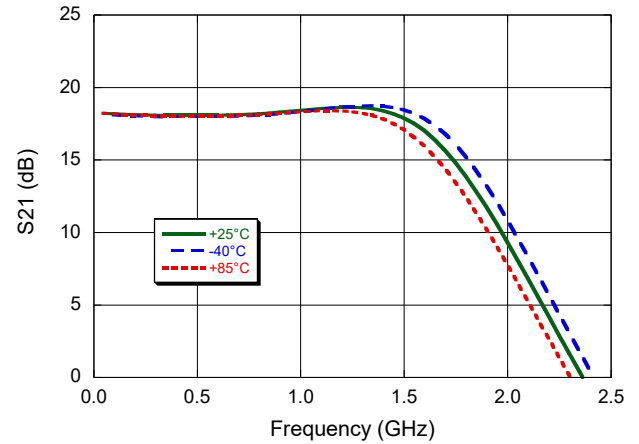

Input Return Loss

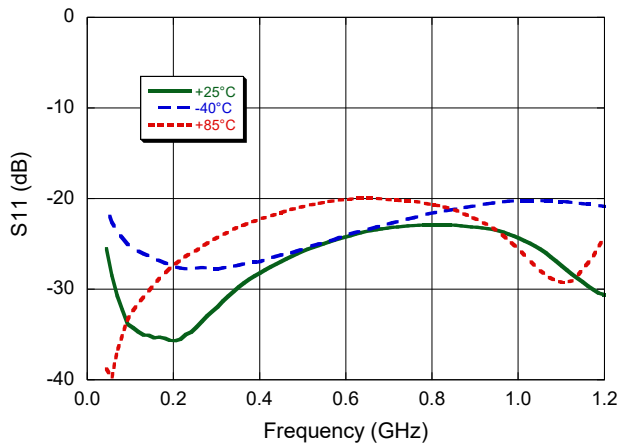

Output Return Loss

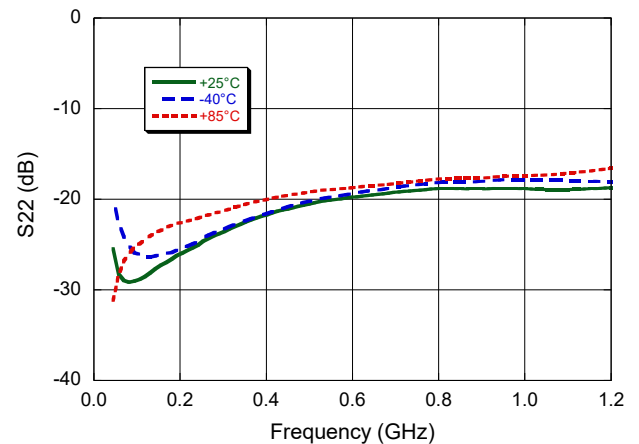

Reverse Isolation

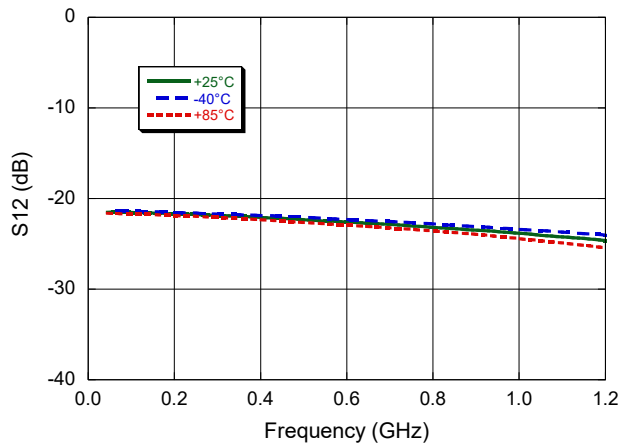

Noise Figure

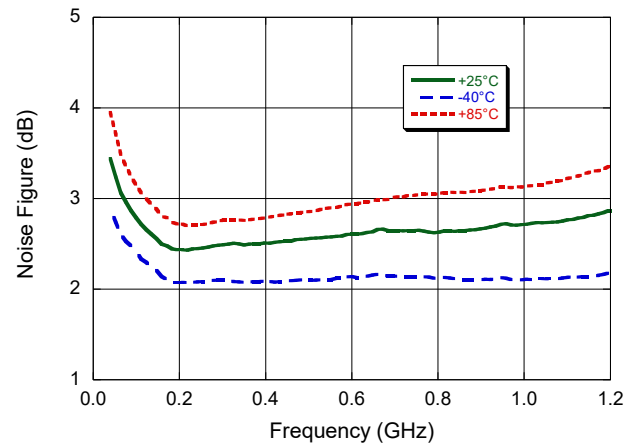

75 Ω , 8 V RF Amplifier 45 - 1218 MHz



MAAM-011182
Rev. V4

Typical Performance Curves: $V_{DD} = 8\text{ V}$

CSO Lower
79 ch, 0 dB tilt, 34 dBmV per ch

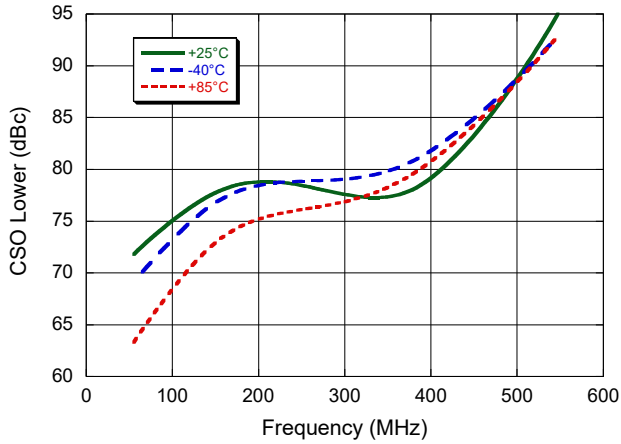

CSO Upper
79 ch, 0 dB tilt, 34 dBmV per ch

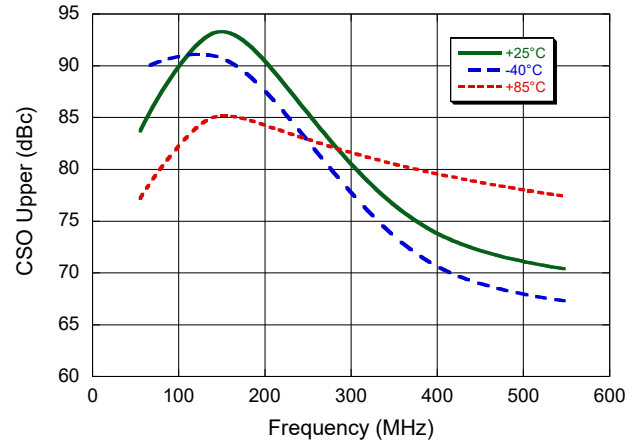

CTB
79 ch, 0 dB tilt, 34 dBmV per ch

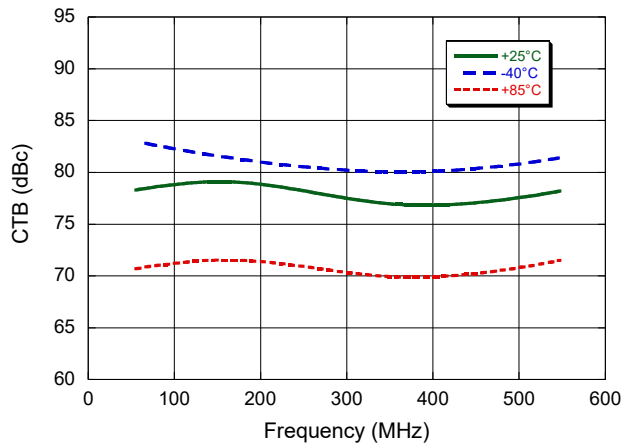

MACOM Technology Solutions Inc. ("MACOM"). All rights reserved.

These materials are provided in connection with MACOM's products as a service to its customers and may be used for informational purposes only. Except as provided in its Terms and Conditions of Sale or any separate agreement, MACOM assumes no liability or responsibility whatsoever, including for (i) errors or omissions in these materials; (ii) failure to update these materials; or (iii) conflicts or incompatibilities arising from future changes to specifications and product descriptions, which MACOM may make at any time, without notice. These materials grant no license, express or implied, to any intellectual property rights.

THESE MATERIALS ARE PROVIDED "AS IS" WITH NO WARRANTY OR LIABILITY, EXPRESS OR IMPLIED, RELATING TO SALE AND/OR USE OF MACOM PRODUCTS INCLUDING FITNESS FOR A PARTICULAR PURPOSE, MERCHANTABILITY, INFRINGEMENT OF INTELLECTUAL PROPERTY RIGHT, ACCURACY OR COMPLETENESS, OR SPECIAL, INDIRECT, INCIDENTAL, OR CONSEQUENTIAL DAMAGES WHICH MAY RESULT FROM USE OF THESE MATERIALS.

MACOM products are not intended for use in medical, lifesaving or life sustaining applications. MACOM customers using or selling MACOM products for use in such applications do so at their own risk and agree to fully indemnify MACOM for any damages resulting from such improper use or sale.