

## Automotive 650 V power Schottky silicon carbide diode

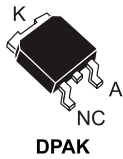
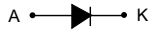

### Features

- AEC-Q101 qualified
- No reverse recovery charge in application current range
- Switching behavior independent of temperature
- Recommended to PFC applications
- PPAP capable
- ECOPACK<sup>®</sup>2 compliant component

### Description

The SiC diode is an ultra-high performance power Schottky diode. It is manufactured using a silicon carbide substrate. The wide band gap material allows the design of a Schottky diode structure with a 650 V rating. Due to the Schottky construction, no recovery is shown at turn-off and ringing patterns are negligible. The minimal capacitive turn-off behavior is independent of temperature.

Especially suited for use in PFC applications, this ST SiC diode will boost performance in hard switching conditions.

Product status	
STPSC6H065BY-TR	
Product summary	
Symbol	Value
$I_{F(AV)}$	6 A
$V_{RRM}$	650 V
$T_{j(max.)}$	175 °C

# 1 Characteristics

**Table 1. Absolute ratings (limiting values at 25 °C unless otherwise specified)**

Symbol	Parameter		Value	Unit
V <sub>RRM</sub>	Repetitive peak reverse voltage	T <sub>j</sub> = -40 °C to + 175 °C	650	V
I <sub>F(RMS)</sub>	Forward rms current		22	A
I <sub>F(AV)</sub>	Average forward current	T <sub>c</sub> = 145 °C <sup>(1)</sup> , DC	6	A
I <sub>FSM</sub>	Surge non repetitive forward current	t <sub>p</sub> = 10 ms sinusoidal, T <sub>c</sub> = 25 °C	60	A
		t <sub>p</sub> = 10 ms sinusoidal, T <sub>c</sub> = 125 °C	52	
		t <sub>p</sub> = 10 μs square, T <sub>c</sub> = 25 °C	400	
I <sub>FRM</sub>	Repetitive peak forward current	T <sub>c</sub> = 145 °C <sup>(1)</sup> , T <sub>j</sub> = 175 °C, δ = 0.1	23	A
T <sub>stg</sub>	Storage temperature range		-55 to +175	°C
T <sub>j</sub>	Operating junction temperature range <sup>(2)</sup>		-40 to +175	°C

1. Value based on R<sub>th(j-c)</sub> max.

2. (dP<sub>tot</sub>/dT<sub>j</sub>) < (1/R<sub>th(j-a)</sub>) condition to avoid thermal runaway for a diode on its own heatsink.

**Table 2. Thermal parameters**

Symbol	Parameter	Typ. value	Max. value	Unit
R <sub>th(j-c)</sub>	Junction to case	1.6	2.4	°C/W

**Table 3. Static electrical characteristics**

Symbol	Parameter	Test conditions		Min.	Typ.	Max.	Unit
		T <sub>j</sub>	V <sub>R</sub>				
I <sub>R</sub> <sup>(1)</sup>	Reverse leakage current	T <sub>j</sub> = 25 °C	V <sub>R</sub> = V <sub>RRM</sub>	-	5	60	μA
		T <sub>j</sub> = 150 °C		-	50	250	
V <sub>F</sub> <sup>(2)</sup>	Forward voltage drop	T <sub>j</sub> = 25 °C	I <sub>F</sub> = 6 A	-	1.45	1.65	V
		T <sub>j</sub> = 150 °C		-	1.7	2.05	

1. t<sub>p</sub> = 10 ms, δ < 2%

2. t<sub>p</sub> = 500 μs, δ < 2%

To evaluate the conduction losses, use the following equation:

$$P = 0.972 \times I_{F(AV)} + 0.180 \times I_{F(RMS)}^2$$

**Table 4. Dynamic electrical characteristics**

Symbol	Parameter	Test conditions	Typ.	Unit
Q <sub>cj</sub> <sup>(1)</sup>	Total capacitive charge	V <sub>R</sub> = 400 V	18	nC
C <sub>j</sub>	Total capacitance	V <sub>R</sub> = 0 V, T <sub>c</sub> = 25 °C, F = 1 MHz	300	pF
		V <sub>R</sub> = 400 V, T <sub>c</sub> = 25 °C, F = 1 MHz	30	

1. Most accurate value for the capacitive charge:  $Q_{cj} = \int_0^{V_{OUT}} c_j(V_R) \times dV_R$

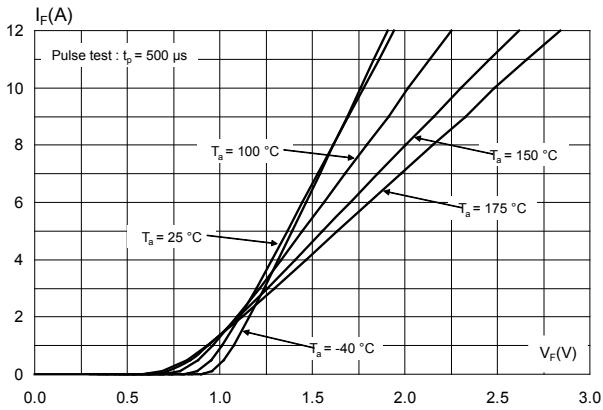
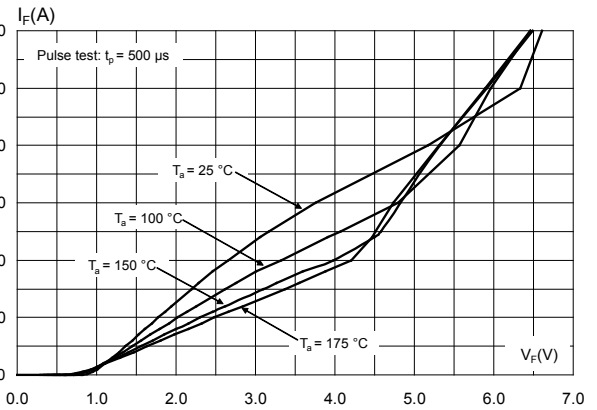
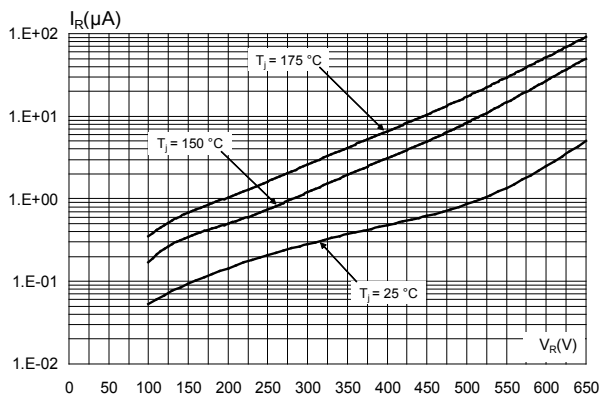
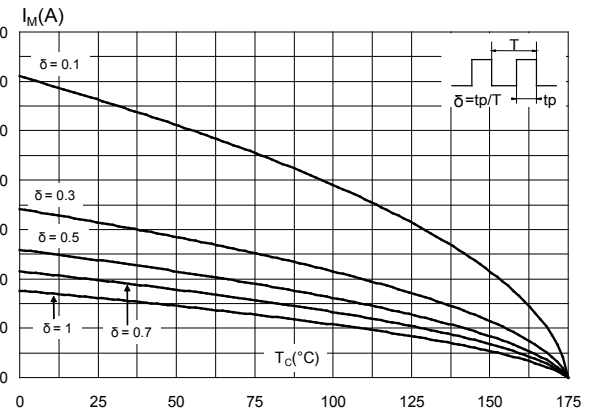
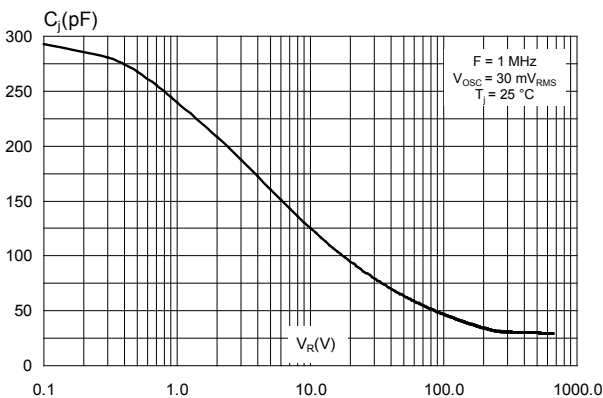
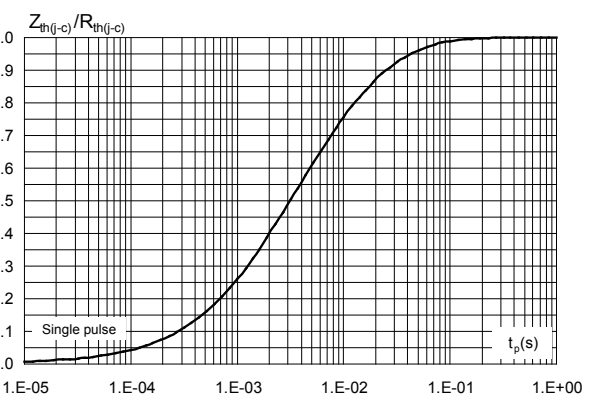
**1.1 Characteristics (curves)**
**Figure 1. Forward voltage drop versus forward current (typical values, low level)**

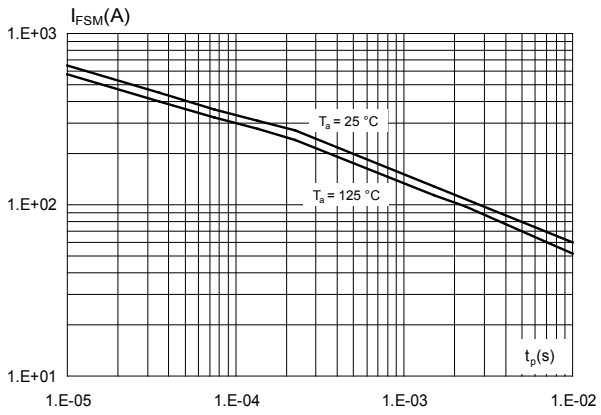
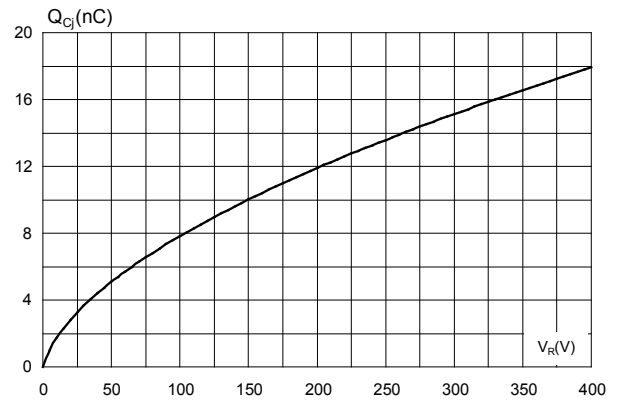
**Figure 2. Forward voltage drop versus forward current (typical values, high level)**

**Figure 3. Reverse leakage current versus reverse voltage applied (typical values)**

**Figure 4. Peak forward current versus case temperature**

**Figure 5. Junction capacitance versus reverse voltage applied (typical values)**

**Figure 6. Relative variation of thermal impedance junction to case versus pulse duration**

**Figure 7. Non-repetitive peak surge forward current versus pulse duration (sinusoidal waveform)**

**Figure 8. Total capacitive charges versus reverse voltage applied (typical values)**

## 2 Package information

In order to meet environmental requirements, ST offers these devices in different grades of ECOPACK<sup>®</sup> packages, depending on their level of environmental compliance. ECOPACK<sup>®</sup> specifications, grade definitions and product status are available at: [www.st.com](http://www.st.com). ECOPACK<sup>®</sup> is an ST trademark.

### 2.1 DPAK package information

- Epoxy meets UL94, V0
- Cooling method: by conduction (C)

**Figure 9. DPAK package outline**

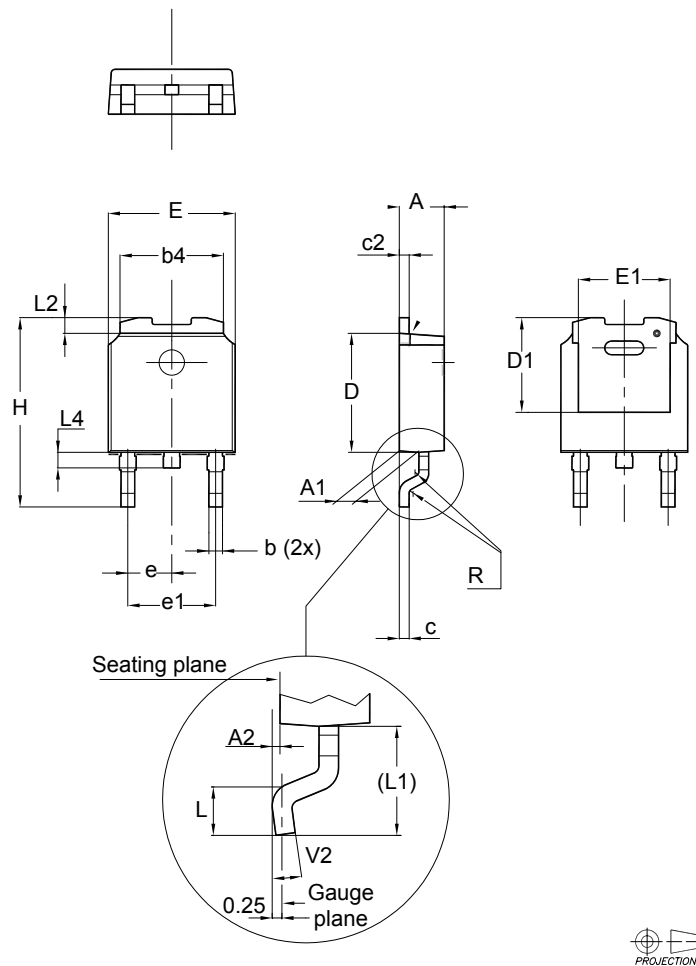

**Table 5. DPAK mechanical data**

Dim.	Dimensions					
	Millimeters			Inches		
	Min.	Typ.	Max.	Min.	Typ.	Max.
A	2.20		2.40	0.087		0.094
A1	0.90		1.10	0.035		0.043
A2	0.03		0.23	0.001		0.009
b	0.64		0.90	0.025		0.035
b4	5.20		5.40	0.205		0.213
c	0.45		0.60	0.018		0.024
c2	0.48		0.60	0.019		0.024
D	6.00		6.20	0.236		0.244
D1	4.95	5.10	5.25	0.195	0.201	0.207
E	6.40		6.60	0.252		0.260
E1	4.60	4.70	4.80	0.181	0.185	0.189
e	2.16	2.28	2.40	0.085	0.090	0.094
e1	4.40		4.60	0.173		0.181
H	9.35		10.10	0.368		0.398
L	1.00		1.50	0.039		0.059
(L1)	2.60	2.80	3.00	0.102	0.110	0.118
L2	0.65	0.80	0.95	0.026	0.031	0.037
L4	0.60		1.00	0.024		0.039
R		0.20			0.008	
V2	0°		8°	0°		8°

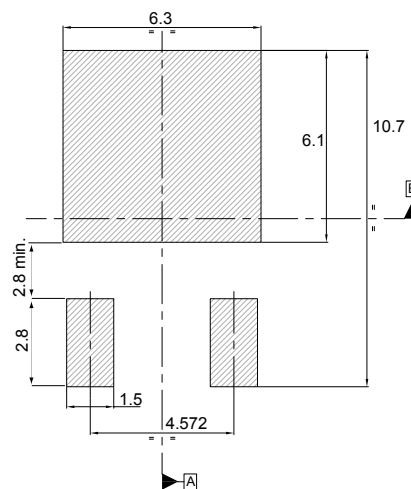
**Figure 10. DPAK recommended footprint (dimensions are in mm)**

 The device must be positioned within  $\boxed{\text{M}0.05\text{A}B}$

### 3 Ordering Information

Table 6. Ordering information

Order code	Marking	Package	Weight	Base qty.	Delivery mode
STPSC6H065BY-TR	PSC6H 065Y	DPAK	0.32 g	2500	Tape and reel

## Revision history

**Table 7. Document revision history**

Date	Version	Changes
13-Mar-2018	1	Initial release.



**IMPORTANT NOTICE – PLEASE READ CAREFULLY**

STMicroelectronics NV and its subsidiaries (“ST”) reserve the right to make changes, corrections, enhancements, modifications, and improvements to ST products and/or to this document at any time without notice. Purchasers should obtain the latest relevant information on ST products before placing orders. ST products are sold pursuant to ST’s terms and conditions of sale in place at the time of order acknowledgement.

Purchasers are solely responsible for the choice, selection, and use of ST products and ST assumes no liability for application assistance or the design of Purchasers’ products.

No license, express or implied, to any intellectual property right is granted by ST herein.

Resale of ST products with provisions different from the information set forth herein shall void any warranty granted by ST for such product.

ST and the ST logo are trademarks of ST. All other product or service names are the property of their respective owners.

Information in this document supersedes and replaces information previously supplied in any prior versions of this document.

© 2018 STMicroelectronics – All rights reserved