

Silicon carbide Power MOSFET 650 V, 18 mΩ typ., 40 A in a PowerFLAT 8x8 HV package

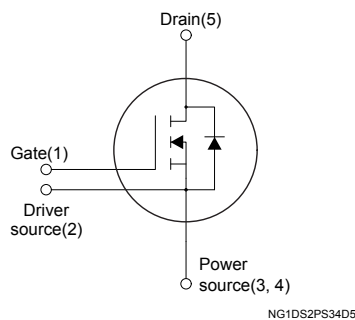
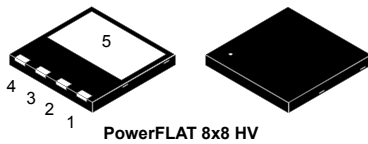

Features

Order code	V _{DS}	R _{DS(on)} max.	I _D
SCTL90N65G2V	650 V	24 mΩ	40 A

- Very fast and robust intrinsic body diode
- Low capacitances
- Source sensing pin for increased efficiency

Applications

- Switching mode power supply
- DC-DC converters
- Industrial motor control

Description

This silicon carbide Power MOSFET device has been developed using ST's advanced and innovative 2nd generation SiC MOSFET technology. The device features remarkably low on-resistance per unit area and very good switching performance. The variation of switching loss is almost independent of junction temperature.



Product status link

[SCTL90N65G2V](#)

Product summary

Order code	SCTL90N65G2V
Marking	90N65G2V
Package	PowerFLAT 8x8 HV
Packing	Tape and reel

1 Electrical ratings

Table 1. Absolute maximum ratings

Symbol	Parameter	Value	Unit
V_{DS}	Drain-source voltage	650	V
V_{GS}	Gate-source voltage	-10 to 22	V
	Gate-source voltage (recommended operating values)	-5 to 18	
$I_D^{(1)}$	Drain current (continuous) at $T_C = 25\text{ °C}$	40	A
	Drain current (continuous) at $T_C = 100\text{ °C}$	40	
$I_{DM}^{(2)}$	Drain current (pulsed)	160	A
P_{TOT}	Total power dissipation at $T_C = 25\text{ °C}$	935	W
T_{stg}	Storage temperature range	-55 to 175	°C
T_J	Operating junction temperature range		°C

1. Value limited by package.
2. Pulse width is limited by safe operating area.

Table 2. Thermal data

Symbol	Parameter	Value	Unit
R_{thJC}	Thermal resistance, junction-to-case	0.16	°C/W
$R_{thJB}^{(1)}$	Thermal resistance, junction-to-board	45	°C/W

1. When mounted on an 1-inch² FR-4, 2 Oz copper board.

2 Electrical characteristics

($T_C = 25\text{ °C}$ unless otherwise specified).

Table 3. On/off states

Symbol	Parameter	Test conditions	Min.	Typ.	Max.	Unit
$V_{(BR)DSS}$	Drain-source breakdown voltage	$V_{GS} = 0\text{ V}$, $I_D = 1\text{ mA}$	650			V
I_{DSS}	Zero gate voltage drain current	$V_{DS} = 650\text{ V}$, $V_{GS} = 0\text{ V}$			10	μA
I_{GSS}	Gate-body leakage current	$V_{DS} = 0\text{ V}$, $V_{GS} = -10\text{ to }22\text{ V}$			± 100	nA
$V_{GS(th)}$	Gate threshold voltage	$V_{DS} = V_{GS}$, $I_D = 1\text{ mA}$	1.8	3.2	5.0	V
$R_{DS(on)}$	Static drain-source on-resistance	$V_{GS} = 18\text{ V}$, $I_D = 40\text{ A}$		18	24	m Ω
		$V_{GS} = 18\text{ V}$, $I_D = 40\text{ A}$, $T_J = 175\text{ °C}$		27		

Table 4. Dynamic, based on HiP247 package option

Symbol	Parameter	Test conditions	Min.	Typ.	Max.	Unit
C_{iss}	Input capacitance	$V_{DS} = 400\text{ V}$, $f = 1\text{ MHz}$, $V_{GS} = 0\text{ V}$	-	3380	-	pF
C_{oss}	Output capacitance		-	294	-	pF
C_{riss}	Reverse transfer capacitance		-	49	-	pF
R_g	Gate input resistance	$f = 1\text{ MHz}$, $I_D = 0\text{ A}$	-	1	-	Ω
Q_g	Total gate charge	$V_{DD} = 400\text{ V}$, $I_D = 50\text{ A}$, $V_{GS} = -5\text{ V to }18\text{ V}$	-	157	-	nC
Q_{gs}	Gate-source charge		-	43	-	nC
Q_{gd}	Gate-drain charge		-	42	-	nC

Table 5. Switching energy (inductive load), based on HiP247 package option

Symbol	Parameter	Test conditions	Min.	Typ.	Max.	Unit
E_{on}	Turn-on switching energy	$V_{GS} = -5\text{ to }18\text{ V}$, $V_{DD} = 400\text{ V}$, $I_D = 50\text{ A}$, $R_G = 2.2\text{ }\Omega$	-	130	-	μJ
E_{off}	Turn-off switching energy		-	210	-	μJ
E_{on}	Turn-on switching energy	$V_{GS} = -5\text{ to }18\text{ V}$, $V_{DD} = 400\text{ V}$, $I_D = 50\text{ A}$, $R_G = 2.2\text{ }\Omega$, $T_C = 150\text{ °C}$	-	135	-	μJ
E_{off}	Turn-off switching energy		-	200	-	μJ

Table 6. Switching times, based on HiP247 package option

Symbol	Parameter	Test conditions	Min.	Typ.	Max.	Unit
$t_{d(on)}$	Turn-on delay time	$V_{DD} = 400\text{ V}$, $I_D = 50\text{ A}$, $R_G = 2.2\text{ }\Omega$, $V_{GS} = -5\text{ V to }18\text{ V}$	-	26	-	ns
t_f	Fall time		-	16	-	ns
$t_{d(off)}$	Turn-off delay time		-	58	-	ns
t_r	Rise time		-	38	-	ns

Table 7. Reverse SiC diode characteristics, based on HiP247 package option

Symbol	Parameter	Test conditions	Min.	Typ.	Max.	Unit
V_{SD}	Forward on voltage	$I_F = 30\text{ A}$, $V_{GS} = 0\text{ V}$	-	2.5	-	V
t_{rr}	Reverse recovery time	$I_F = 50\text{ A}$, $di/dt = 4000\text{ A}/\mu\text{s}$, $V_{DD} = 400\text{ V}$	-	17	-	ns
Q_{rr}	Reverse recovery charge		-	308	-	nC
I_{RRM}	Reverse recovery current		-	30	-	A

2.1 Electrical characteristics (curves)

Figure 1. Safe operating area

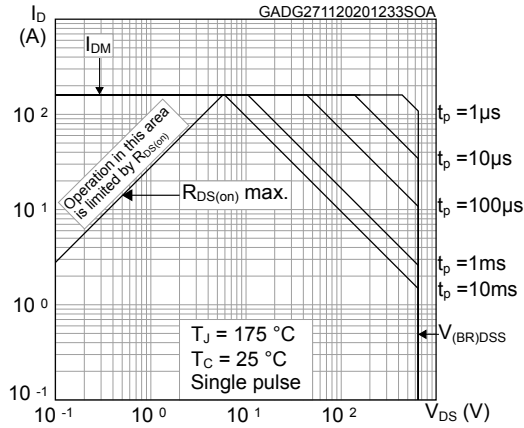

Figure 2. Maximum transient thermal impedance

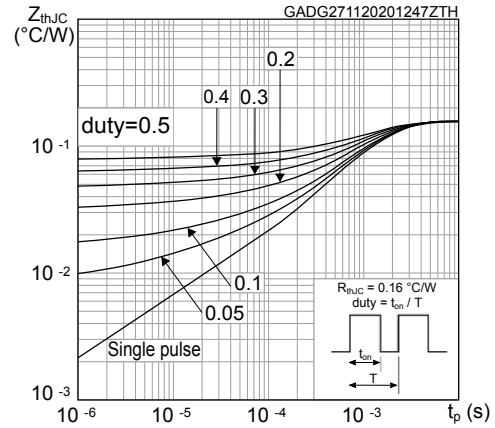

Figure 3. Typical output characteristics (T_J = -50 °C)

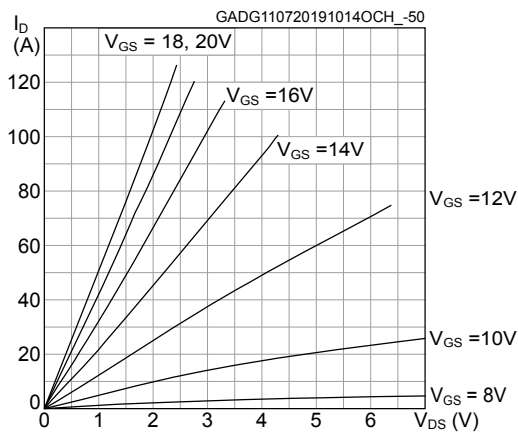

Figure 4. Typical output characteristics (T_J = 25 °C)

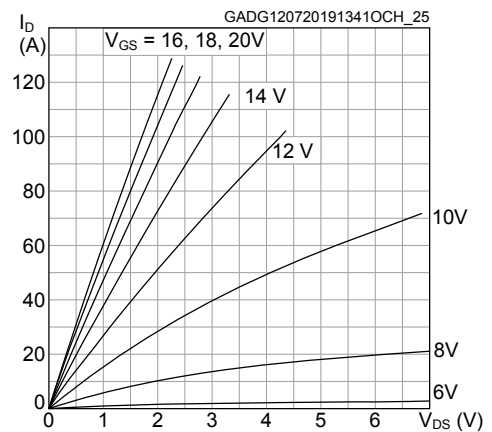

Figure 5. Typical output characteristics (T_J = 175 °C)

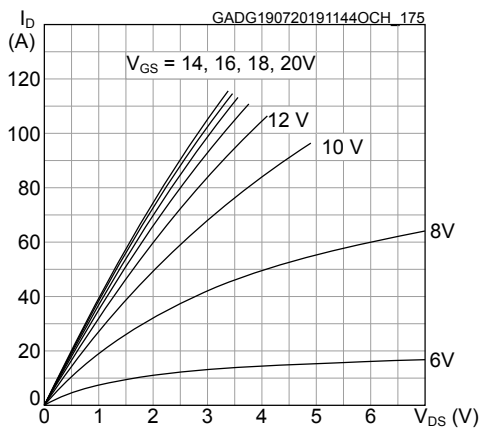

Figure 6. Typical transfer characteristics

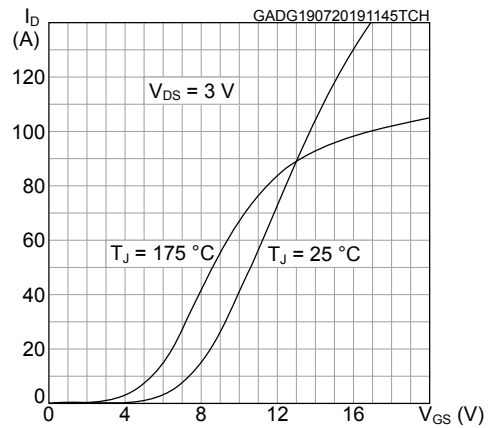

Figure 7. Typical capacitance characteristics, based on HiP247 package option

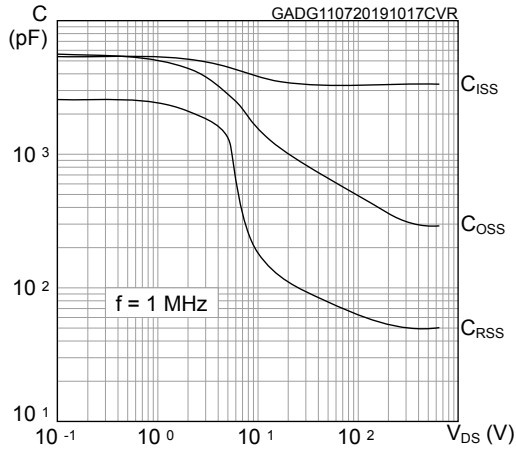

Figure 8. Typical gate charge characteristics, based on HiP247 package option

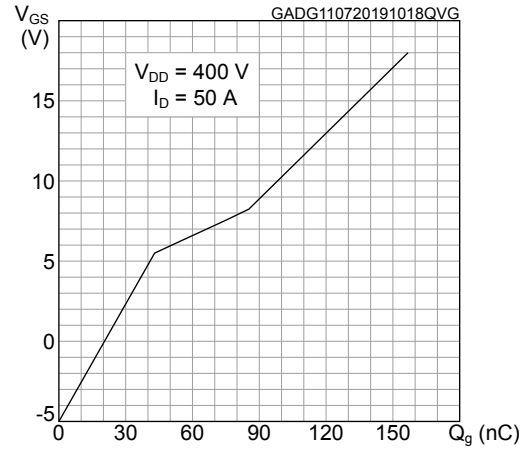

Figure 9. Total power dissipation

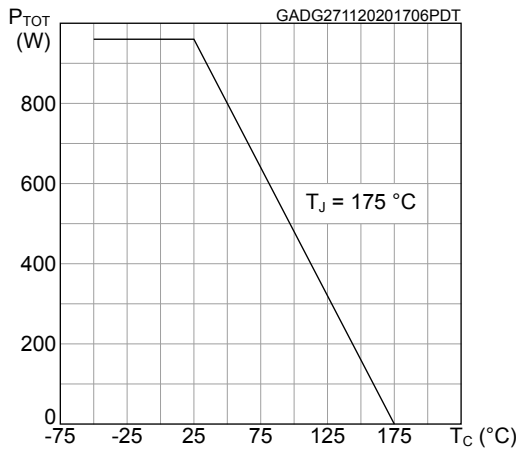

Figure 10. Normalized on-resistance vs temperature

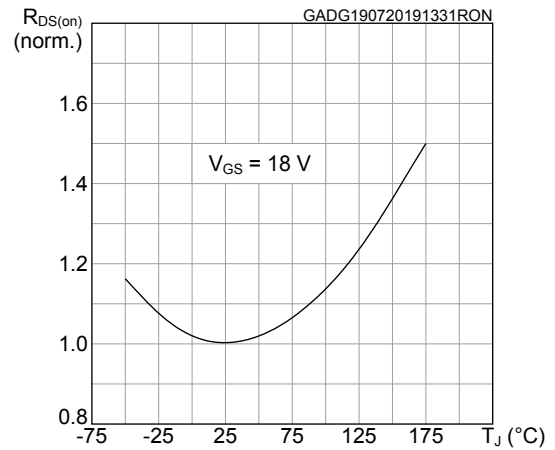

Figure 11. Normalized gate threshold vs temperature

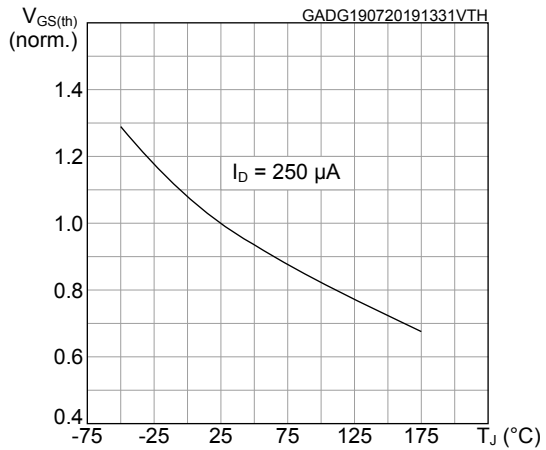

Figure 12. Normalized breakdown voltage vs temperature

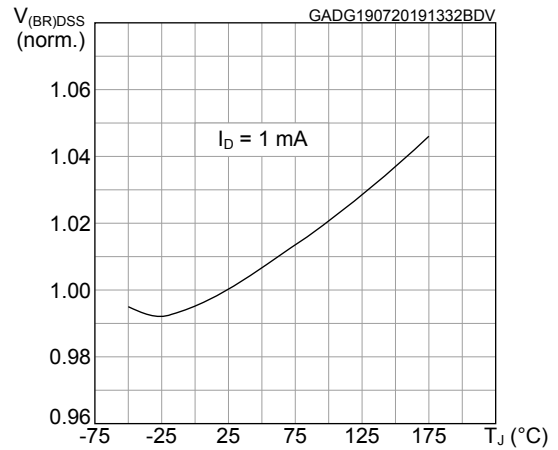

Figure 13. Typical switching energy vs drain current, based on HiP247 package option

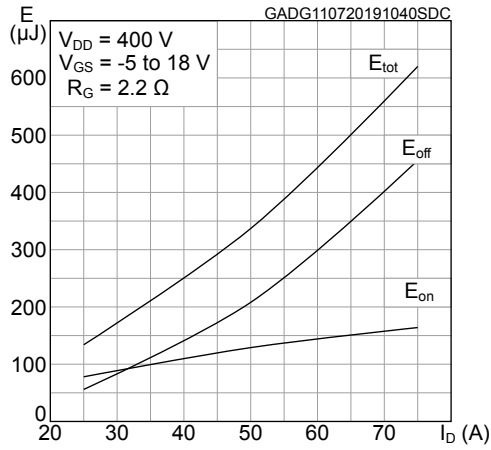

Figure 14. Typical switching energy vs temperature

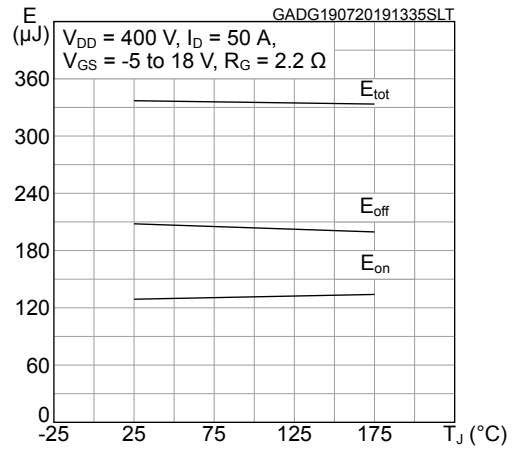

Figure 15. Typical reverse conduction characteristics ($T_J = -50\ ^{\circ}\text{C}$)

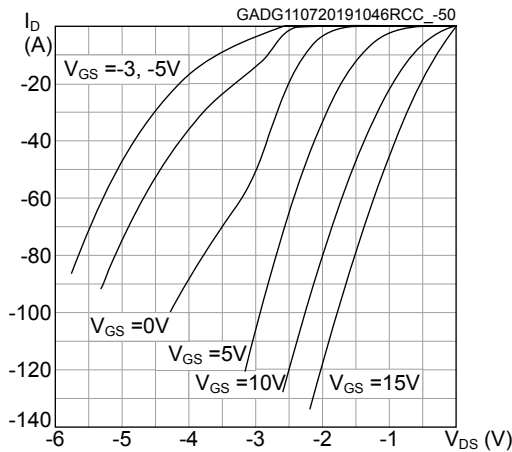

Figure 16. Typical reverse conduction characteristics ($T_J = 25\ ^{\circ}\text{C}$)

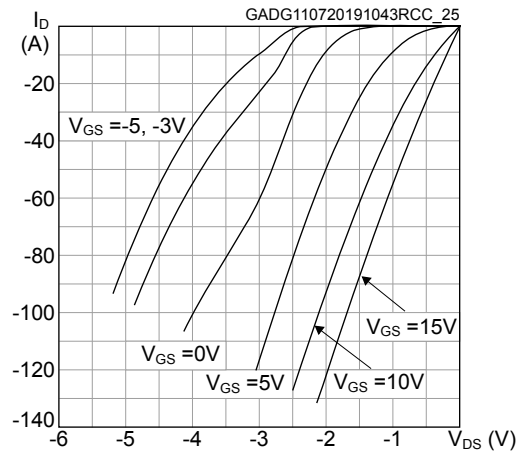
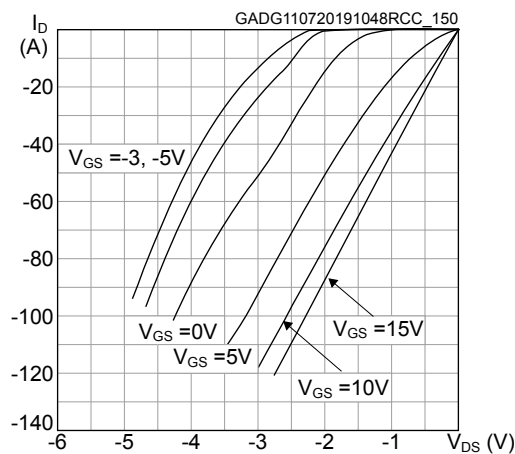

Figure 17. Typical reverse conduction characteristics ($T_J = 150\ ^{\circ}\text{C}$)



3 Package information

In order to meet environmental requirements, ST offers these devices in different grades of **ECOPACK** packages, depending on their level of environmental compliance. ECOPACK specifications, grade definitions and product status are available at: www.st.com. ECOPACK is an ST trademark.

3.1 PowerFLAT 8x8 HV type A package information

Figure 18. PowerFLAT 8x8 HV type A package outline

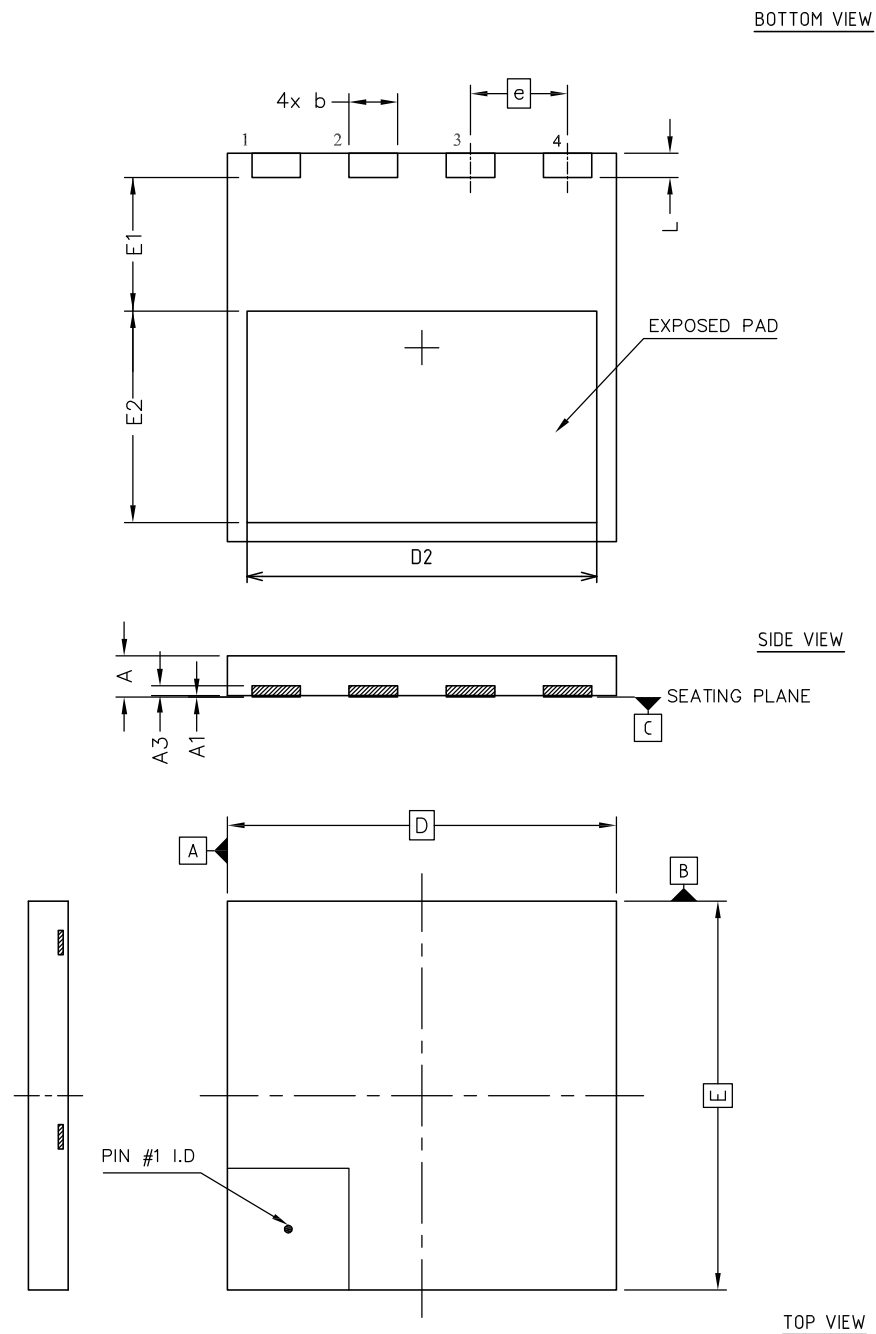

8222871_Rev_4

Table 8. PowerFLAT 8x8 HV type A mechanical data

Ref.	Dimensions (in mm)		
	Min.	Typ.	Max.
A	0.75	0.85	0.95
A1	0.00		0.05
A3	0.10	0.20	0.30
b	0.90	1.00	1.10
D	7.90	8.00	8.10
E	7.90	8.00	8.10
D2	7.10	7.20	7.30
E1	2.65	2.75	2.85
E2	4.25	4.35	4.45
e	2.00 BSC		
L	0.40	0.50	0.60

Figure 19. PowerFLAT 8x8 HV footprint

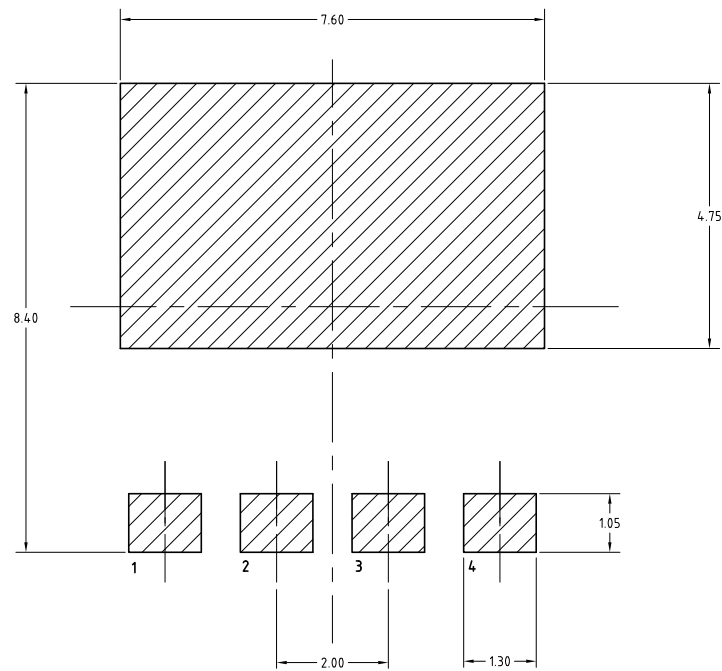

8222871_REV_4_footprint

Note: All dimensions are in millimeters.

3.2 PowerFLAT 8x8 HV packing information

Figure 20. PowerFLAT 8x8 HV tape

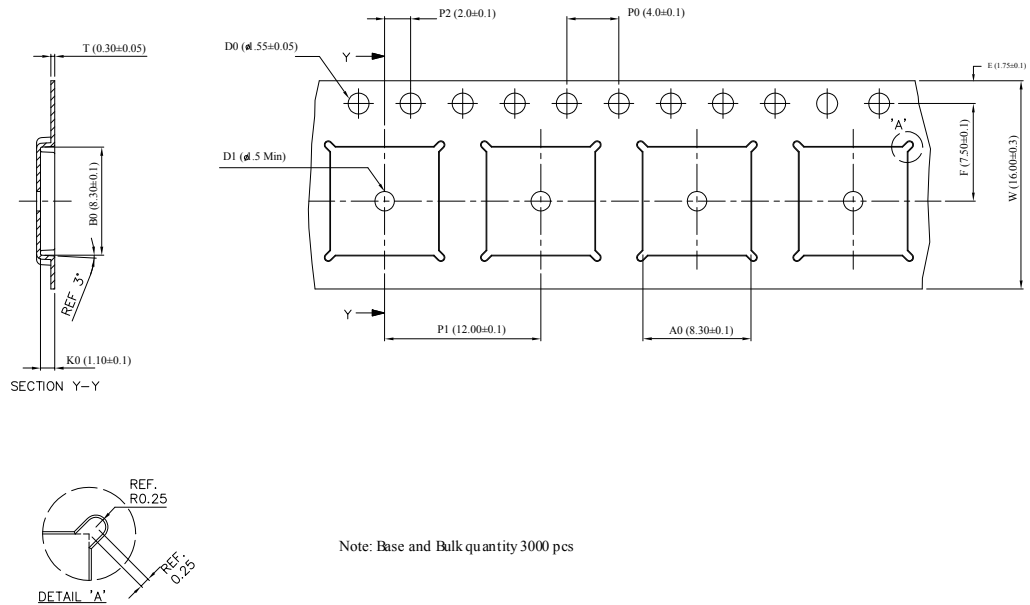

8229819_Tape_revA

Note: All dimensions are in millimeters.

Figure 21. PowerFLAT 8x8 HV package orientation in carrier tape

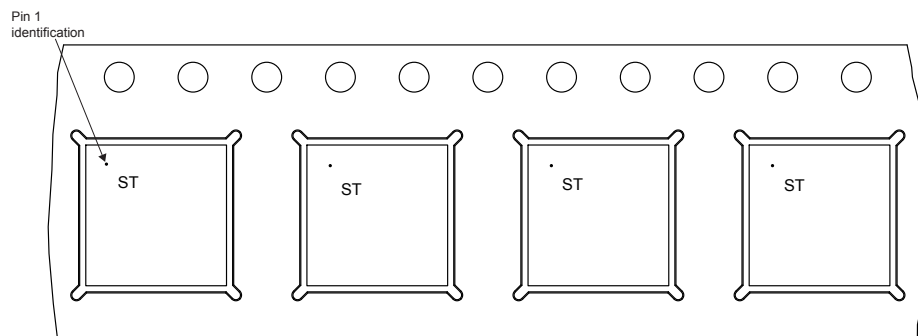

Revision history

Table 9. Document revision history

Date	Version	Changes
10-Dec-2020	1	First release.

Contents

1	Electrical ratings	2
2	Electrical characteristics	3
2.1	Electrical characteristics (curves)	5
3	Package information	8
3.1	PowerFLAT 8x8 HV type A package information	8
3.2	PowerFLAT 8x8 HV packing information	10
	Revision history	12

IMPORTANT NOTICE – PLEASE READ CAREFULLY

STMicroelectronics NV and its subsidiaries (“ST”) reserve the right to make changes, corrections, enhancements, modifications, and improvements to ST products and/or to this document at any time without notice. Purchasers should obtain the latest relevant information on ST products before placing orders. ST products are sold pursuant to ST’s terms and conditions of sale in place at the time of order acknowledgement.

Purchasers are solely responsible for the choice, selection, and use of ST products and ST assumes no liability for application assistance or the design of Purchasers’ products.

No license, express or implied, to any intellectual property right is granted by ST herein.

Resale of ST products with provisions different from the information set forth herein shall void any warranty granted by ST for such product.

ST and the ST logo are trademarks of ST. For additional information about ST trademarks, please refer to www.st.com/trademarks. All other product or service names are the property of their respective owners.

Information in this document supersedes and replaces information previously supplied in any prior versions of this document.

© 2020 STMicroelectronics – All rights reserved