

### Features

- Single Device: +5V Input
- Complimentary Dual Output:  $\pm 12V$ ,  $\pm 15V$
- Wide Input Voltage Range
- 85% Efficiency
- Adjustable Output Voltage
- Laser-trimmed

### Description

The PT5060 series of dual-output Integrated Switching Regulators (ISRs) provide a complimentary  $\pm 12V$  or  $\pm 15V$  from a single +5V input. Applications include systems that require power for analog interface circuitry, such as D/A and A/D converters, and Op Amps. The output voltage can be adjusted with an external resistor. These ISRs are made available in a 12-pin single in-line pin (SIP) package. Note that these modules are not short-circuit protected.

### Standard Application

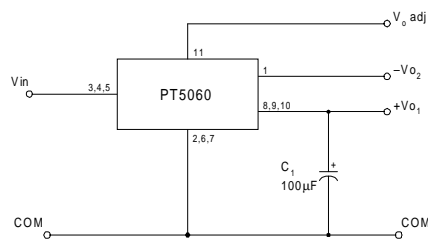

$C_1$  = Required 100µF electrolytic

### Pin-Out Information

Pin	Function
1	$-V_{O2}$
2	GND
3	$V_{in}$
4	$V_{in}$
5	$V_{in}$
6	GND
7	GND
8	$+V_{O1}$
9	$+V_{O1}$
10	$+V_{O1}$
11	$V_o$ Adj
12	Do Not Connect

### Ordering Information

PT 5061□ =  $\pm 12$  Volts  
PT 5062□ =  $\pm 15$  Volts

### PT Series Suffix (PT1234 x)

Case/Pin Configuration	Order Suffix	Package Code *
Vertical	<b>N</b>	(ECD)
Horizontal	<b>A</b>	(ECA)
SMD	<b>C</b>	(ECC)
Vertical, Side Tabs	<b>R</b>	(ECE)
Horizontal, Side Tabs	<b>G</b>	(ECG)
SMD, Side Tabs	<b>B</b>	(ECK)

\* Previously known as package style 300.  
(Reference the applicable package code drawing for the dimensions and PC board layout)

### Specifications (Unless otherwise stated, $T_a = 25^\circ C$ , $V_{in} = +5V$ , $I_o = I_{o,max}$ , $C_1 = 100\mu F$ )

Characteristics	Symbol	Conditions	PT5060 SERIES			Units	
			Min	Typ	Max		
Output Current	$I_o$	Over $V_{in}$ range	$V_{O1} = +12V$ $V_{O2} = -12V$	0.05 0.05 (1)	— —	0.50 0.25	A
Current Limit	$I_{lim}$			—	150 (2)	—	% $I_{o,max}$
Inrush Current	$I_{ir}$	On start up		—	5.5 (3)	—	A
	$t_{tr}$			—	2	—	mSec
Input Voltage Range	$V_{in}$	Over $I_o$ range		4.75	—	$+V_o - 1$	V
Output Voltage Tolerance	$\Delta V_o$	Over $V_{in}$ and $I_o$ ranges $T_a = 0^\circ C$ to SOA limit (3)	$+V_{O1}$ $-V_{O2}$	— —	$\pm 1.5$ $\pm 5$	$\pm 3.0$ $\pm 10$	% $V_o$
Line Regulation	$Reg_{line}$	Over $V_{in}$ range		—	$\pm 0.5$	$\pm 1.0$	% $V_o$
Load Regulation	$Reg_{load}$	$0.1 \leq I_o \leq I_{o,max}$		—	$\pm 0.5$	$\pm 1.0$	% $V_o$
$V_o$ Ripple (pk-pk)	$V_n$	20MHz bandwidth	$+V_{O1}$ $-V_{O2}$	— —	$\pm 1.5$ $\pm 2$	$\pm 3$ $\pm 3$	% $V_o$
Transient Response	$t_{tr}$ $V_{os}$	25% load change $V_o$ over/undershoot		— —	100 3	— 5	$\mu$ Sec % $V_o$
Efficiency	$\eta$	$I_o = 0.2A$ each output		—	85	—	%
Switching Frequency	$f_s$	Over $V_{in}$ and $I_o$ ranges		—	650	—	kHz
Operating Temperature Range	$T_a$	—		0	—	$+85$ (4)	$^\circ C$
Storage Temperature	$T_s$	—		-40	—	$+125$	$^\circ C$
Mechanical Shock		Per Mil-STD-883D, Method 2002.3, 1 msec, Half Sine, mounted to a fixture	—	500	—	G's	
Mechanical Vibration		Per Mil-STD-883D, Method 2007.2 20-2000 Hz, Soldered in a PC board	—	15	—	G's	
Weight				—	6.5	—	grams

- Notes:**
- (1) Do not operate the negative output rail of these ISRs below the minimum load.
  - (2) ISRs based on a boost topology are not short-circuit protected.
  - (3) The inrush current stated is above the normal input current for the associated output load.
  - (4) See Safe Operating Area curves or consult the factory for the appropriate derating.

9-W +5V-Input Dual-Output  
Integrated Switching Regulator

**PT5061 +/- 12VDC** (See Note A)

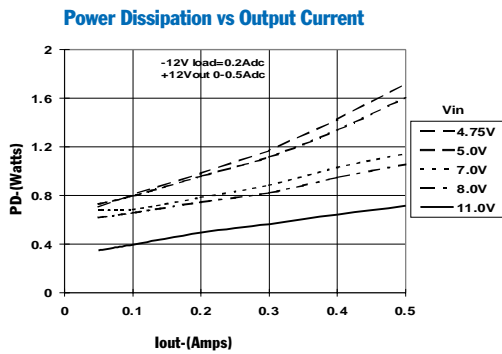
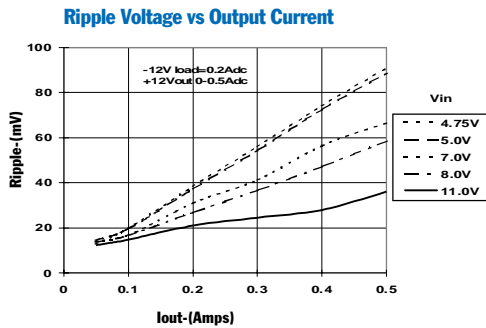
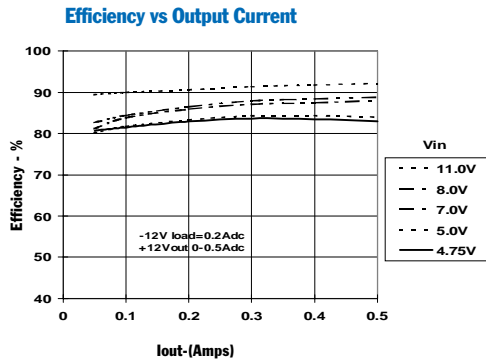

**Safe Operating Area,  $V_{in} = 5.0V$ ;  $I_{o2} = 0.25A$**  (See Note B)

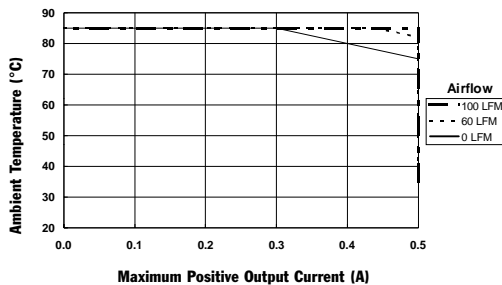

**PT5062 +/- 15V** (See Note A)

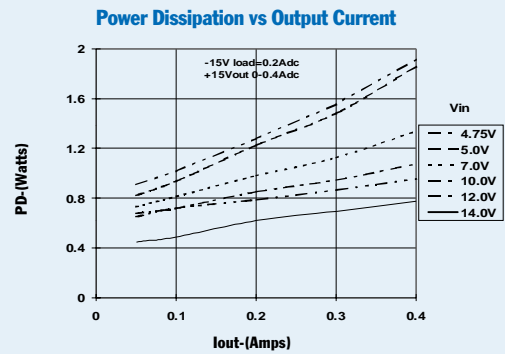
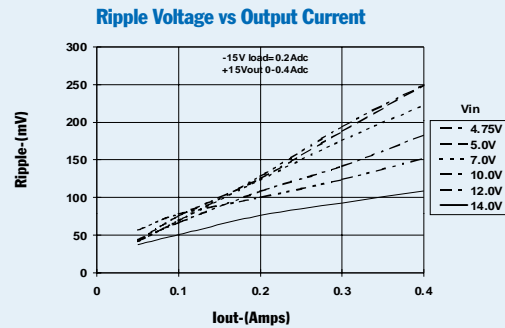
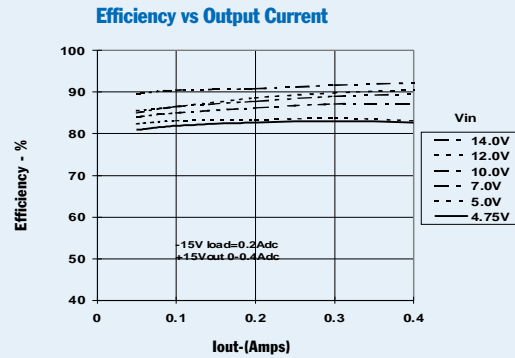

**Safe Operating Area  $V_{in} = 5.0V$ ,  $I_{o2} = 0.2A$**  (See Note B)

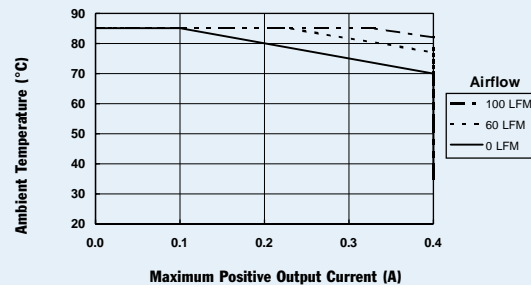

**Note A:** Characteristic data has been developed from actual products tested at 25°C. This data is considered typical data for the Converter.  
**Note B:** Thermal derating graphs are developed in free-air convection cooling, which corresponds to approximately 40-60 LFM of airflow.

## Adjusting the Output Voltage of the PT5060 Dual-Output Boost Converter Series

The dual output voltage of the PT5060 series modules can be adjusted higher or lower than the factory pre-set voltage with the addition of a single external resistor. Table 1 gives the applicable adjustment range for each model in the series as  $V_a$  (min) and  $V_a$  (max).

**Adjust Up:** An increase in the output voltage is obtained by adding a resistor  $R_2$ , between pin 11 ( $V_o$  adj) and pins 2, 6, or 7 (GND).

**Adjust Down:** Add a resistor ( $R_1$ ), between pin 11 ( $V_o$  adj) and pins 8, 9 or 10 ( $V_{o1}$ ).

Refer to Figure 1 and Table 2 for both the placement and value of the required resistor, either ( $R_1$ ) or  $R_2$  as appropriate.

### Notes:

- Both the positive and negative voltage outputs from the ISR are adjusted simultaneously.
- Use only a single 1% resistor in either the ( $R_1$ ) or  $R_2$  location. Place the resistor as close to the ISR as possible.
- Never connect capacitors from  $V_o$  adj to either GND or  $V_{o1}$ . Any capacitance added to the  $V_o$  adjust pin will affect the stability of the ISR.
- An increase in the output voltage must be accompanied by a corresponding reduction in the specified maximum current at each output. For  $V_{o1}$  and  $-V_{o2}$ , the revised maximum output current must be reduced to the equivalent of 6 watts and 3 watts respectively. i.e.

$$I_{o1}(\text{max}) = \frac{6}{V_a} \text{ A dc}$$

$$\text{and } I_{o2}(\text{max}) = \frac{3}{V_a} \text{ A dc,}$$

where  $V_a$  is the adjusted output voltage.

- Adjustments to the output voltage will also limit the maximum input voltage that can be applied to the ISR. The maximum input voltage that may be applied is limited to  $(V_o - 1)\text{Vdc}$  or 14Vdc, whichever is less.

Figure 1

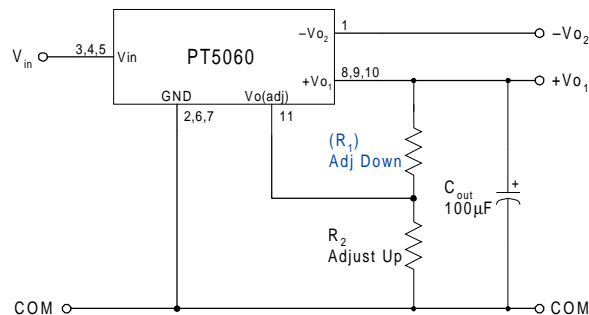

The values of ( $R_1$ ) [adjust down], and  $R_2$  [adjust up], can also be calculated using the following formulas.

$$(R_1) = \frac{3.65 (V_a - 2.5)}{(V_o - V_a)} - 0.1 \quad \text{k}\Omega$$

$$R_2 = \frac{9.125}{V_a - V_o} - 0.1 \quad \text{k}\Omega$$

Where:  $V_o$  = Original output voltage  
 $V_a$  = Adjusted output voltage

Table 1  
PT5060 ADJUSTMENT AND FORMULA PARAMETERS

Series Pt #	PT5061	PT5062
$V_o$ (nom)	±12.0V	±15.0V
$V_a$ (min)	± 7.5V	± 7.5V
$V_a$ (max)	±14.0V	±20.0V

Table 2  
PT5060 ADJUSTMENT RESISTOR VALUES

Series Pt #	PT5061	PT5062
Current	0.5/0.25A dc	0.4/0.2A dc
$V_o$ (nom)	±12.0Vdc	±15.0Vdc
$V_a$ (req'd)		
7.0		
7.5	(4.0)kΩ	(2.3)kΩ
8.0	(4.9)kΩ	(2.8)kΩ
8.5	(6.2)kΩ	(3.3)kΩ
9.0	(7.8)kΩ	(3.9)kΩ
9.5	(10.1)kΩ	(4.6)kΩ
10.0	(13.6)kΩ	(5.4)kΩ
10.5	(19.4)kΩ	(6.4)kΩ
11.0	(30.9)kΩ	(7.7)kΩ
11.5	(65.6)kΩ	(9.3)kΩ
12.0		(11.5)kΩ
12.5	18.2kΩ	(14.5)kΩ
13.0	9.0kΩ	(19.1)kΩ
13.5	6.0kΩ	(26.7)kΩ
14.0	4.5kΩ	(41.9)kΩ
14.5		(87.5)kΩ
15.0		
15.5		18.2kΩ
16.0		9.0kΩ
16.5		6.0kΩ
17.0		4.5kΩ
17.5		3.6kΩ
18.0		2.9kΩ
18.5		2.5kΩ
19.0		2.2kΩ
19.5		1.9kΩ
20.0		1.7kΩ

$R_1$  = (Blue)       $R_2$  = Black

## IMPORTANT NOTICE

Texas Instruments Incorporated and its subsidiaries (TI) reserve the right to make corrections, modifications, enhancements, improvements, and other changes to its products and services at any time and to discontinue any product or service without notice. Customers should obtain the latest relevant information before placing orders and should verify that such information is current and complete. All products are sold subject to TI's terms and conditions of sale supplied at the time of order acknowledgment.

TI warrants performance of its hardware products to the specifications applicable at the time of sale in accordance with TI's standard warranty. Testing and other quality control techniques are used to the extent TI deems necessary to support this warranty. Except where mandated by government requirements, testing of all parameters of each product is not necessarily performed.

TI assumes no liability for applications assistance or customer product design. Customers are responsible for their products and applications using TI components. To minimize the risks associated with customer products and applications, customers should provide adequate design and operating safeguards.

TI does not warrant or represent that any license, either express or implied, is granted under any TI patent right, copyright, mask work right, or other TI intellectual property right relating to any combination, machine, or process in which TI products or services are used. Information published by TI regarding third-party products or services does not constitute a license from TI to use such products or services or a warranty or endorsement thereof. Use of such information may require a license from a third party under the patents or other intellectual property of the third party, or a license from TI under the patents or other intellectual property of TI.

Reproduction of information in TI data books or data sheets is permissible only if reproduction is without alteration and is accompanied by all associated warranties, conditions, limitations, and notices. Reproduction of this information with alteration is an unfair and deceptive business practice. TI is not responsible or liable for such altered documentation.

Resale of TI products or services with statements different from or beyond the parameters stated by TI for that product or service voids all express and any implied warranties for the associated TI product or service and is an unfair and deceptive business practice. TI is not responsible or liable for any such statements.

### Mailing Address:

Texas Instruments  
Post Office Box 655303  
Dallas, Texas 75265