

SAC-5P-M12MS/ 1,5-802/M12FR-3L

Order No.: 1454480

<http://eshop.phoenixcontact.de/phoenix/treeViewClick.do?UID=1454480>

Sensor/Actuator cable, 5-position, PUR halogen-free, welding sputter-resistant, highly flexible, Gray RAL 7001, Plug, straight M12, A-coded, on Socket, angled M12, A-coded, Cable length: 1.5 m

Commercial data

GTIN (EAN)	 4 046356 578196
Note	Made-to-order
sales group	D112
Pack	1 pcs.
Customs tariff	85444290

Product notes

WEEE/RoHS-compliant since:
04/30/2010



<http://www.download.phoenixcontact.com>
Please note that the data given here has been taken from the online catalog. For comprehensive information and data, please refer to the user documentation. The General Terms and Conditions of Use apply to Internet downloads.

Technical data**General data**

Rated current at 40°C	4 A
Rated voltage	24 V
Number of positions	5
Volume resistance	≤ 5 mΩ

Insulation resistance	≥ 100 MΩ
Length of cable	1.5 m
Ambient temperature (operation)	-25 °C ... 90 °C (Male connector / female connector)

General characteristics

Standards/regulations	M12 connector IEC 61076-2-101
Coding	A - standard
Surge voltage category	II
Pollution degree	3
Degree of protection	IP65/IP68/IP69K
Insertion/withdrawal cycles	≥ 100
Contact material	CuSn
Contact surface material	Ni/Au
Contact carrier material	TPU GF
Material of grip body	TPU, hardly inflammable, self-extinguishing
Material, knurls	Zinc die-cast, (nickel-plated)
Sealing material	NBR
Status display	3 LEDs

Conductor data

Cable type	PUR halogen-free, highly flexible, resistant to welding beads, gray
Cable type (abbreviation)	802
Cable abbreviation	Li12Y11Y-HF
Conductor cross section	0.34 mm ²
AWG signal line	22
Conductor structure signal line	42x 0.10 mm
Core diameter including insulation	1.3 mm ±0.05 mm
External cable diameter	5.1 mm ±0.2 mm
Wire colors	Black, brown, blue, white, green/yellow
External sheath, color	Gray RAL 7001
Insulation resistance	min. 20 MΩ*km
Conductor resistance	Approx. 53 Ω/km
Nominal voltage, conductor	300 V
Test voltage, conductor	1200 V
Overall twist	5 wires around filler to the core
Outer sheath, material	PUR

Material conductor insulation	PES
Conductor material	Bare Cu litz wires
Smallest bending radius, fixed installation	26 mm
Smallest bending radius, movable installation	26 mm
Number of bending cycles	15000000
Bending radius	50 mm
Traversing path	0.9 m
Traversing rate	5 m/s
Acceleration	30 m/s ²
Torsion force	± 360 °/m
Ambient temperature (operation)	-40 °C ... 90 °C (cable, fixed installation) -30 °C ... 90 °C (cable, flexible installation)
Special properties	Sheath resistant to welding beads, can be recycled, matt, without adhesion, wear-resistant, flame resistant and self-extinguishing Free from silicone and cadmium Free of substances which would hinder coating with paint or varnish
Flame resistance	DIN VDE 0472 part 804, test type B IEC 60332-1 In accordance with UL FT-2
Halogen-free	The cable is halogen-free
Resistance to oil	As per VDE 0472 Part 803
Other resistance	Highly resistant to acids, alkaline solutions and solvents

Diagrams/Drawings

Dimensioned drawing

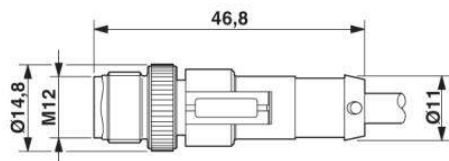

M12 x 1 male connector, straight

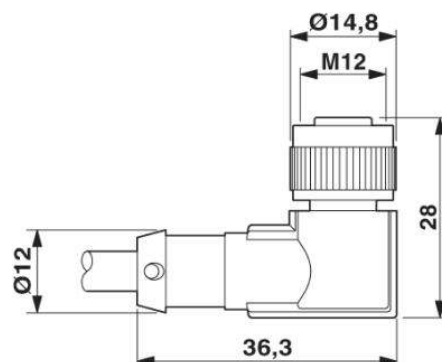

M12 x 1 female connector, angled

Circuit diagram

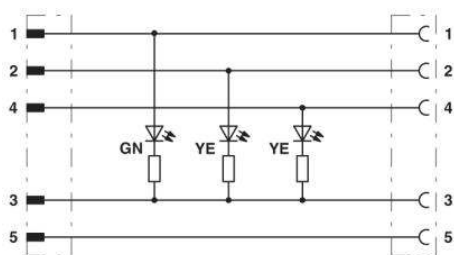

Contact assignment of M12 connectors / sockets with 3 LEDs

Schematic diagram

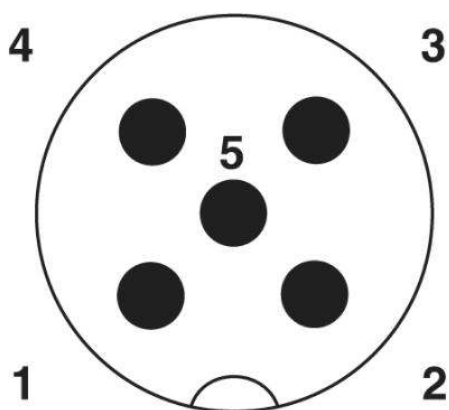

Pin assignment M12 male connector, 5-pos., A-coded, male side

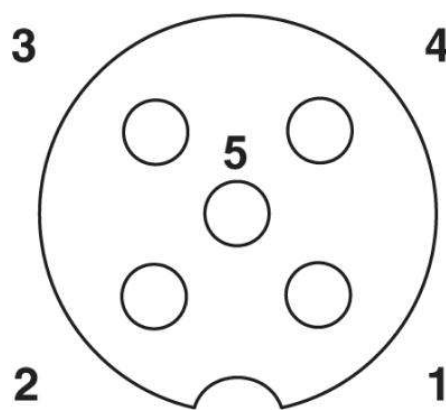

Pin assignment M12 socket, 5-pos., A-coded, socket side view

Address

PHOENIX CONTACT Inc., USA
586 Fulling Mill Road
Middletown, PA 17057, USA
Phone (800) 888-7388
Fax (717) 944-1625
<http://www.phoenixcon.com>



© 2011 Phoenix Contact
Technical modifications reserved;