

Long Distance Square Inductive Proximity Sensor

# E2Q5

## Square Proximity Sensor

- M12 Plug-in connection
- Integrated short circuit and reverse polarity protection
- Active face positioning:  
Y-axis 15°, X-axis 90°  
increments





### Ordering Information

Sensing distance	Connection	Active face	Output		
				NO	NO + NC
20 mm shielded	Plug-in connector	Changable	NPN	E2Q5-N20E1-M1	E2Q5-N20E3-M1
			PNP	E2Q5-N20F1-M1	E2Q5-N20F3-M1
40 mm non-shielded			NPN	E2Q5-N40ME1-M1	E2Q5-N40ME3-M1
			PNP	E2Q5-N40MF1-M1	E2Q5-N40MF3-M1





E2Q5

Rating/performance

Item	Model	shielded	non-shielded
		E2Q5-N20□□-M1	E2Q5-N40M□3-M1
Sensing distance Sn		20 mm ± 10%	40 mm ± 10%
Standard target size, L x W x H, Fe 37		60 x 60 x 1 mm	120 x 120 x 1 mm
Setting distance		0 to 16,2 mm	0 to 32,4 mm
Switching frequency		150 Hz	
Sensing object		Ferrous metals	
Differential travel		15% max. of sensing distance Sn	
Operating voltage		10 to 30 VDC	
Current consumption		20 mA max.	
Control output	Type	E2Q5-N□□□E1-□□: NPN - NO E2Q5-N□□□E3-□□: NPN - NO + NC E2Q5-N□□□F1-□□: PNP - NO E2Q5-N□□□F3-□□: PNP - NO + NC	
	Load	200 mA max.	
	On-stage voltage drop	3 VDC max. (at 200 mA load current)	
Circuit protection		Reverse polarity, output short circuit	
Indicator		Operating indicator (yellow LED), operating voltage (green LED)	
Ambient temperature		Operating: -25° to 85°C	
Ambient humidity		35 to 95% RH	
Influence of temperature		± 10% max. of Sn at 23° in temperature range of -25° to 70°C	
Dielectric strength		1.500 VAC, 50/60 Hz for 1 min. between current carry parts and case	
Electromagnetic compatibility EMC		EN 60947-5-2	
Vibration resistance		10 to 55 Hz, 1 mm amplitude according IEC 60068-2-6	
Shock resistance		Approx. 30 G for 11 ms according to IEC 60068-2-27	
Protection degree		IP67 IEC 60529, IP69K DIN 40050	
Connection	Connector	M12 plug, 4 pins	
Material	Case	PBT	
	Sensing face	PBT	
Approvals			

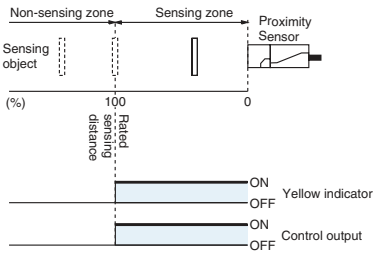
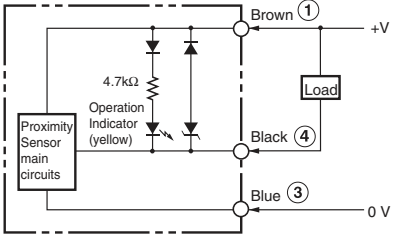
Output Circuit Diagramm

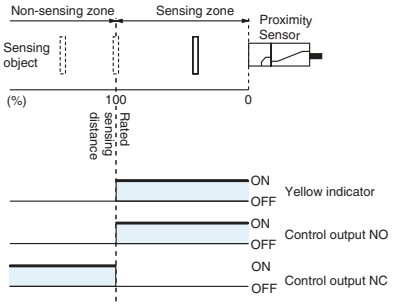
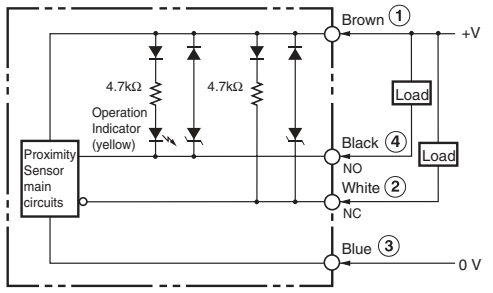
NPN output

Model	Operation mode	Timing chart	Output circuit
<p>E2Q5-N20E1-M1 E2Q5-N40ME1-M1</p>	<p>NO</p>	 <p>Non-sensing zone    Sensing zone    Proximity Sensor</p> <p>Sensing object</p> <p>(%)    100    0</p> <p>Rated sensing distance</p> <p>ON OFF    Yellow indicator</p> <p>ON OFF    Control output</p>	 <p>Connector Pin Arrangement</p>  <p>Note: Terminal 2 is not used</p>
<p>E2Q5-N20E3-M1 E2Q5-N40ME3-M1</p>	<p>NO + NC</p>	 <p>Non-sensing zone    Sensing zone    Proximity Sensor</p> <p>Sensing object</p> <p>(%)    100    0</p> <p>Rated sensing distance</p> <p>ON OFF    Yellow indicator</p> <p>ON OFF    Control output NO</p> <p>ON OFF    Control output NC</p>	 <p>Connector Pin Arrangement</p> 

E2Q5

PNP output

Model	Operation mode	Timing chart	Output circuit
E2Q5-N20F1-M1 E2Q5-N40MF1-M1	NO	<p>Non-sensing zone    Sensing zone    Proximity Sensor</p> <p>Sensing object</p> <p>(%)    100    0</p> <p>Rated sensing distance</p> <p>ON    OFF    Yellow indicator</p> <p>ON    OFF    Control output</p>	<p>Connector Pin Arrangement</p> <p>Note: Terminal 2 is not used</p>
E2Q5-N20F3-M1 E2Q5-N40MF3-M1	NO + NC	<p>Non-sensing zone    Sensing zone    Proximity Sensor</p> <p>Sensing object</p> <p>(%)    100    0</p> <p>Rated sensing distance</p> <p>ON    OFF    Yellow indicator</p> <p>ON    OFF    Control output NO</p> <p>ON    OFF    Control output NC</p>	<p>Connector Pin Arrangement</p>

Dimensions (Unit:mm)

E2Q5-...-M1 type

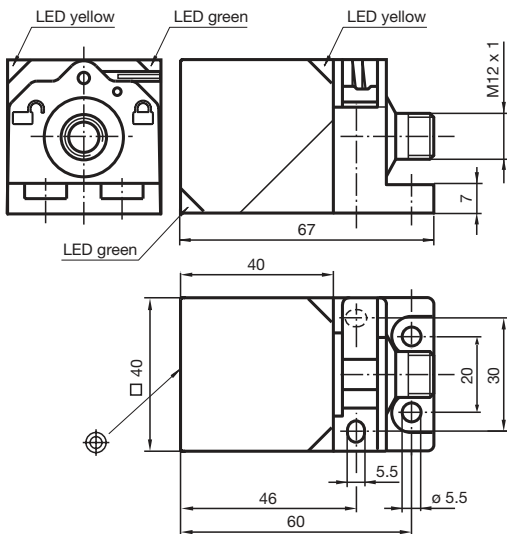

Precautions

 **Caution**

**Power supply**

Do not impose an excessive voltage on the E2Q2, otherwise it may explode or burn.

Do not connect an AC power supply to any DC model. If AC power (100 VAC or more) is supplied to the sensor, it may explode or burn.

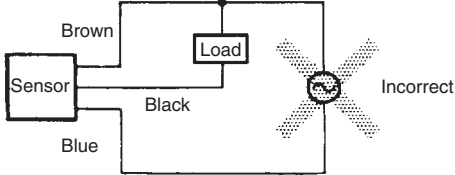

Be sure to abide by the following precautions for the safe operation of the Sensor.

**Wiring**

**Power Supply Voltage and Output Load**

**Power Supply Voltage**

Make sure that the power supply to the Sensor is within the rated voltage range. If a voltage exceeding the rated voltage range is supplied to the Sensor, it may explode or burn.

**Load Short-circuiting**

Do not short-circuit the load, otherwise the Sensor may be damaged.

**Connection without Load**

Do not connect the power supply to the Sensor with no load connected, otherwise the internal elements may explode or burn.

**Operating Environment**

Do not use the Sensor in locations with explosive or flammable gas.

**Correct Use**

**Design**

**Effects of Surrounding Metal**

Provide a minimum distance between the Sensor and the surrounding metal as shown in the table below.

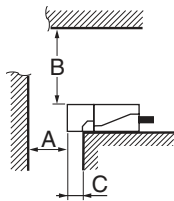

Effects of Surrounding Metal (Unit: mm)

Model	Length	A	B	C
E2Q5-N20□□-M1		45	0	0
E2Q5-N40M□□-M1		120	300	40

**Mutual Interference**

If more than one Sensor is located in parallel, ensure to maintain enough space between adjacent Sensors to suppress mutual interference as provided in the following diagram.

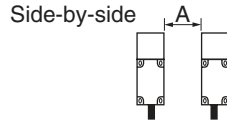

Mutual Interference (Unit: mm)

Model	Length	A
E2Q5-N20□□-M1		40
E2Q5-N40M□□-M1		150

**Power Reset Time**

The Sensor is ready to operate within 300 ms after the Sensor is turned ON. If the load and Sensor are connected to independent power supplies respectively, be sure to turn ON the Sensor before supplying power to the load.

**Power OFF**

The Proximity Sensor may output a pulse signal when it is turned OFF. Therefore, it is recommended that the load be turned OFF before turning OFF the Proximity Sensor.

**Power Supply Transformer**

When using a DC power supply, make sure that the DC power supply has an insulated transformer. Do not use a DC power supply with an auto-transformer.

**Sensing Object**

The sensing distance of the Proximity Sensor vary with the metal coating on sensing objects.

**Wiring**

**High-tension cables**

Wiring through Metal Conduit:

If there is power or high-tension line near the cable of the Proximity Sensor, wire the cable through an independent metal conduit to prevent against Proximity Sensor damage or malfunction.

E2Q5

## Mounting

### Mounting the Sensor

The Proximity Sensor must be subjected to excessive shock with a hammer when it is installed, otherwise the Proximity Sensor may be damaged or lose its water-resistivity.

## Maintenance and Inspection

Periodically perform the following checks to ensure stable operation of the Proximity Sensor over a long period of time.

- Check for mounting position, dislocation, looseness or distortion of the Proximity Sensor and sensing objects.
- Check for loose wiring and connections, improper contacts and line breakage.
- Check for attachment or accumulation of metal powder or dust.
- Check for abnormal temperature conditions and other environmental conditions.

Never disassemble or repair the Sensor.

## Environment

### Water Resistivity

Do not use the Proximity Sensor underwater, outdoors or in the rain.

### Operating Environment

Be sure to use the Proximity Sensor within its operating ambient temperature range and do not use the Proximity Sensor outdoors so that its reliability and life expectancy can be maintained. Although the Proximity Sensor is water resistive, a cover to protect the Proximity Sensor from water or water-soluble machining oil is recommended so that its reliability and life expectancy can be maintained.

Do not use the Proximity Sensor in an environment with chemical gas (e.g., strong alkaline or acid gasses including nitric, chromic and concentrated sulfuric acid gases).

### Inrush Current

A load that has a large inrush current (e.g., a lamp or motor) will damage the Proximity Sensor, in this case connect the load to the Proximity Sensor through a Relay

ALL DIMENSIONS SHOWN ARE IN MILLIMETERS.

To convert millimeters into inches, multiply by 0.03937. To convert grams into ounces, multiply by 0.03527.