

REVISIONS					
REV	ECO	DESCRIPTION	DATE	BY	APPR
A1	-	RELEASE NEW DRAWING	15JUN18	SULLEN	TOMMY
A2	-	REVISED DRAWING	10JUL20	JHEAD	DH

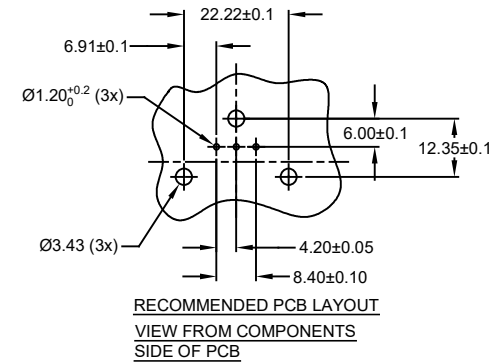
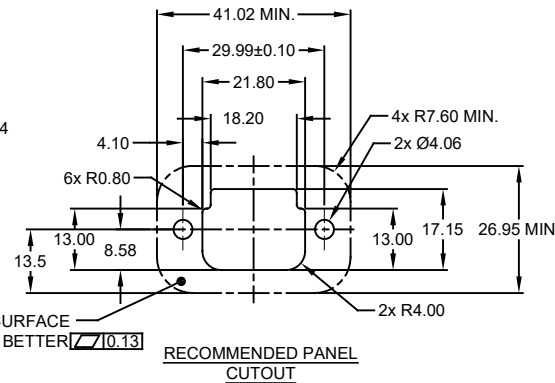
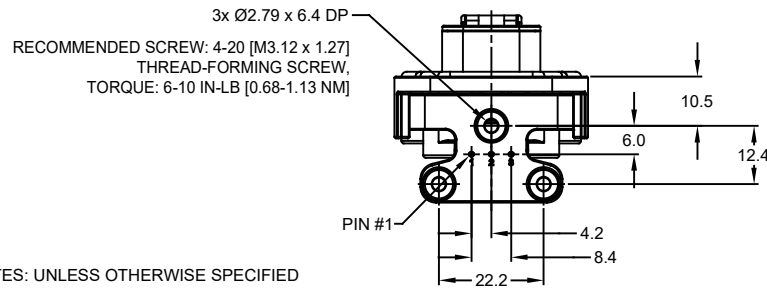
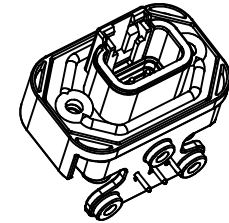
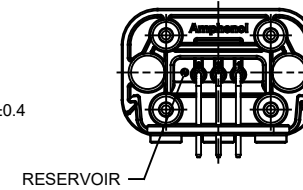
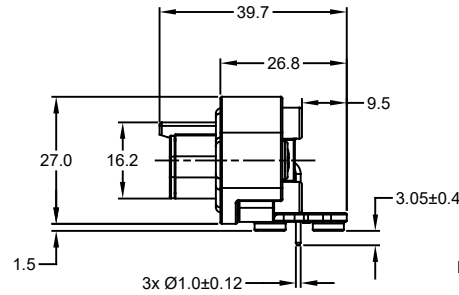
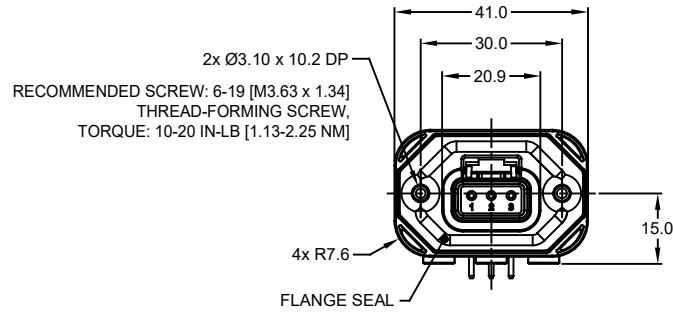

NOTES: UNLESS OTHERWISE SPECIFIED

- MATERIAL:
HOUSING: THERMOPLASTIC, GREY
SEAL: SILICONE RUBBER
CONTACT: COPPER ALLOY
- MODIFICATIONS: FLANGE; RA PCB MOUNT
- SPECIFICATIONS:
3.1 CURRENT RATING: 7.5 AMPS
3.2 OPERATING TEMPERATURE: -55°C TO +125°C
3.3 DIELECTRIC WITHSTANDING VOLTAGE: LESS THAN 2 MILLIAMPS CURRENT LEAKAGE @ 1500 VOLTS AC.
3.4 INSULATION RESISTANCE: 1000 MEGOHMS MIN @ 25°C
3.5 MOISTURE RESISTANCE: IP67 (MATED CONDITION)
3.6 MATING CYCLE DURABILITY: 100 CYCLES
3.7 RoHS COMPLIANT
- MATING PART: ATM06-3S* (* = ALL MODIFICATIONS)
- ALL DIMENSIONS ARE FOR REFERENCE USE ONLY
- POTTED CONNECTORS SPECIFIED FOR UP TO 5 P.S.I. APPLICATIONS.

INTERNAL SEALING SURFACE FINISH TO BE $\sqrt{0.13}$ OR BETTER

RECOMMENDED PANEL CUTOUT

RECOMMENDED PCB LAYOUT
VIEW FROM COMPONENTS
SIDE OF PCB

ATM13-3P-BMXX VARIANTS		
CONTACT PLATING	POTTING OR NOT IN RESERVOIR	PART NUMBER
GOLD	NO POTTING	ATM13-3P-BM01
GOLD	POTTING	ATM13-3P-BM02
TIN	NO POTTING	ATM13-3P-BM03
TIN	POTTING	ATM13-3P-BM04

ATM13-3P-BMXX		PART NUMBER		DESCRIPTION		ITEM
QUANTITY		MATERIALS LIST				
UNLESS OTHERWISE SPECIFIED		SIGNATURES		DATE		<p>Sine Systems - www.amphenol-sine.com 44724 Morley Drive Clinton Township, MI 48036</p> <p>BOARDLOCK PCB MOUNT RECEPTACLE, 3 PIN, RA FLANGE, ATM SERIES</p>
1) All dimensions are in metric (mm).		DRAWN: SULENZHANG	15JUN18		<p>SIZE: B C- TYPE: DWG NO: ATM13-3P-BMXX REVISION: A2</p> <p>SCALE: NONE SHEET 1 OF 1</p>	
2) Tolerances are as follows:		CHECKED: ORIONLI	15JUN18			
1 PL DEC ±0.30 Fractions ±1/64 2 PL DEC ±0.15 3 PL DEC ±0.08		ENGINEER: TOMMY XIE	15JUN18			
3) Note reference =		APPROVAL: TOMMY XIE		15JUN18		
MATERIAL SPECIFICATIONS:		CUSTOMER:		THIS DRAWING IS SUPPLIED FOR INFORMATION ONLY. DESIGN FEATURES, SPECIFICATIONS AND PERFORMANCE DATA SHOWN HEREON ARE THE PROPERTY OF THE AMPHENOL CORPORATION. NO RIGHTS OF REPRODUCTION ARE IMPLIED. ALL DIMENSIONS ARE SUBJECT TO NORMAL MANUFACTURING VARIATIONS.		
PROCESS SPECIFICATIONS:		NEXT ASSY:				

TITLE: POSITION RECEPTACLE, 3PIN, RA FLANGE, ATM SERIES
DWG NO: ATM13-3P-BMXX
REV: A2
SHEET 1 OF 1