

NO. OF CKTS.	DIM. A	DIM. B
1	(2.44 ± .15) .096 ± .006	—
2	(4.98 ± .15) .196 ± .006	(2.54 ± .10) .100 ± .004
3	(7.52 ± .15) .296 ± .006	(5.08 ± .10) .200 ± .004
4	(10.06 ± .15) .396 ± .006	(7.62 ± .10) .300 ± .004
5	(12.60 ± .18) .496 ± .007	(10.16 ± .13) .400 ± .005
6	(15.14 ± .18) .596 ± .007	(12.70 ± .13) .500 ± .005
7	(17.68 ± .20) .696 ± .008	(15.24 ± .15) .600 ± .006
8	(20.22 ± .20) .796 ± .008	(17.78 ± .15) .700 ± .006
9	(22.76 ± .20) .896 ± .008	(20.32 ± .15) .800 ± .006
10	(25.30 ± .25) .996 ± .010	(22.86 ± .20) .900 ± .008
11	(27.84 ± .25) 1.096 ± .010	(25.40 ± .20) 1.000 ± .008
12	(30.38 ± .25) 1.196 ± .010	(27.94 ± .20) 1.100 ± .008
13	(32.92 ± .25) 1.296 ± .010	(30.48 ± .20) 1.200 ± .008
14	(35.46 ± .25) 1.396 ± .010	(33.02 ± .20) 1.300 ± .008
15	(38.00 ± .28) 1.496 ± .011	(35.56 ± .23) 1.400 ± .009
16	(40.54 ± .28) 1.596 ± .011	(38.10 ± .23) 1.500 ± .009
17	(43.08 ± .28) 1.696 ± .011	(40.64 ± .23) 1.600 ± .009
18	(45.62 ± .28) 1.796 ± .011	(43.18 ± .23) 1.700 ± .009
19	(48.16 ± .28) 1.896 ± .011	(45.72 ± .23) 1.800 ± .009
20	(50.70 ± .30) 1.996 ± .012	(48.26 ± .25) 1.900 ± .010

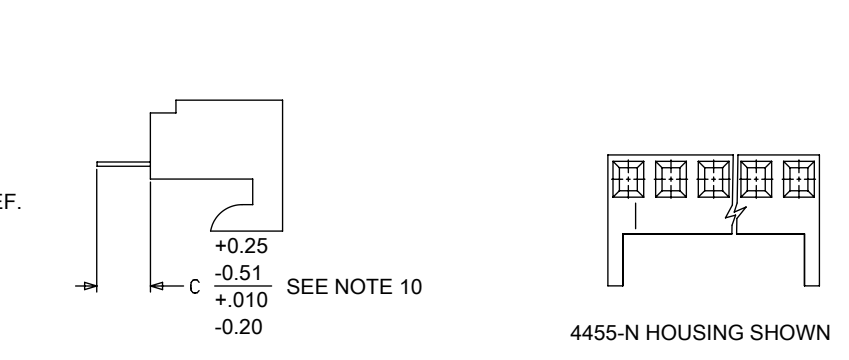

- NOTES:
- MATERIAL: NYLON, UL 94V-0, COLOR: WHITE
  - FINISH:
    - (208) - SELECT GOLD: (0.00038)/.000015 MIN., SELECT TIN: (0.00254)/.000100 MIN. OVERALL NICKEL UNDERPLATE: (0.00127)/.000050 MIN.
    - (228) - SELECT GOLD: (0.00076)/.000030 MIN., SELECT TIN: (0.00254)/.000100 MIN. OVERALL NICKEL UNDERPLATE: (0.00127)/.000050 MIN.
    - (231) - SELECT GOLD: (0.00127)/.000050 MIN., SELECT TIN: (0.00254)/.000100 MIN. OVERALL NICKEL UNDERPLATE: (0.00127)/.000050 MIN.
    - (565) - SELECT GOLD: (0.00051)/.000020 MIN., OVERALL NICKEL: (0.00076)/.000030 MIN. OVERALL GOLD FLASH: (0.00005)/.000002 MIN.
    - (P909) - OVERALL TIN: (0.00254)/.000100 MIN.
  - PARTS CONFORM TO PRODUCT SPECIFICATION PS-10-07.
  - PACKAGING: SEE CHARTS.
  - PARTS MUST CONFORM TO SOLDERABILITY SPEC 152.
  - PARTS ARE STACKABLE END TO END ON (2.54)/.100 CENTERS.
  - TYPICAL PCB THICKNESS: (1.57)/.062
  - PART CONFORMS TO CLASS B REQUIREMENTS OF COSMETIC SPECIFICATION PS-45499-002 EXCEPT PROTRUSIONS. PARTS MAY HAVE MORE THAN 2 GATE MARKS.
  - WHEN MATING ASSEMBLIES THAT USE 4455-BN HOUSINGS TO BREAKAWAY FRICTION LOCK OR POLARIZING HEADERS, THE END BACKWALLS MUST BE REMOVED.
  - DIMENSION C MEASURED WITH TERMINAL PUSHED IN AGAINST THE STOP.

DOCUMENT STATUS	P1	RELEASE DATE	2022/07/29	12:32:02
-----------------	----	--------------	------------	----------

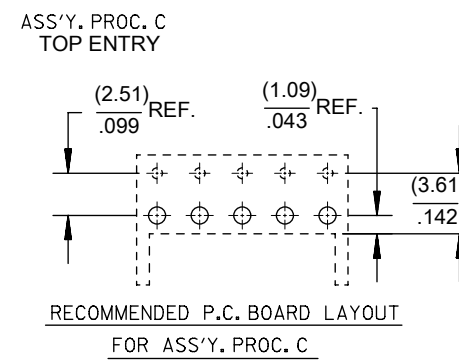
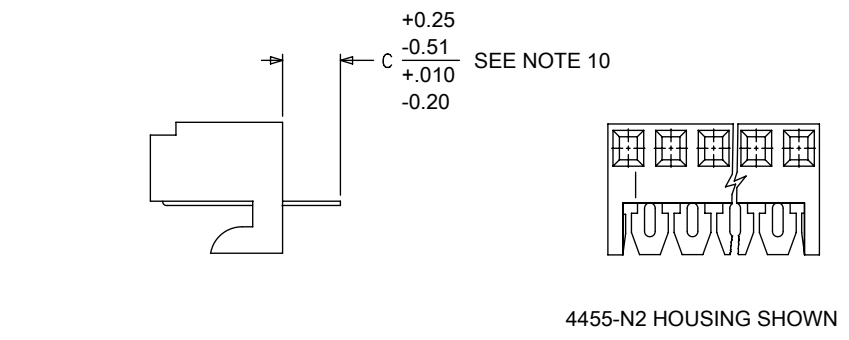
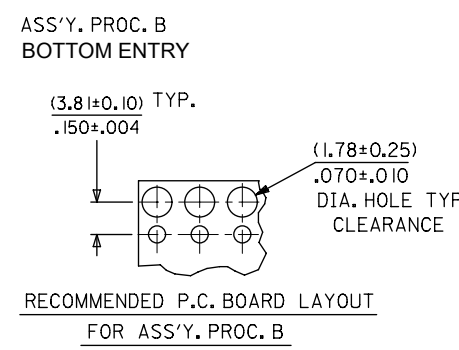
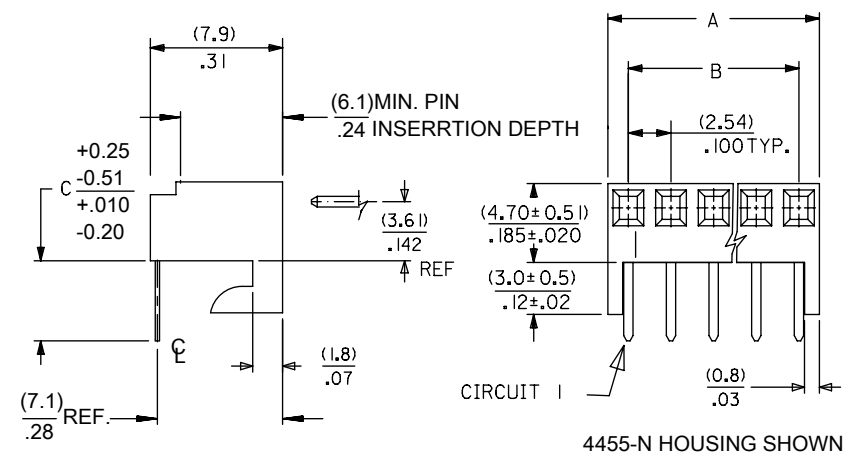
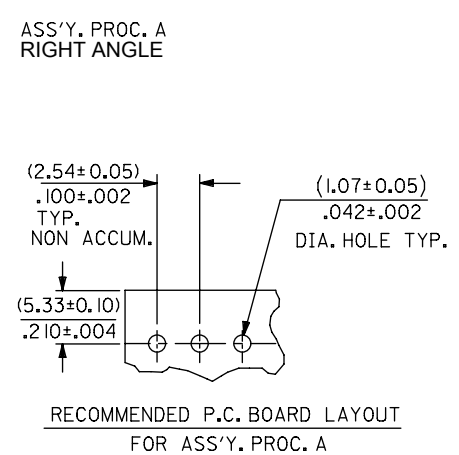
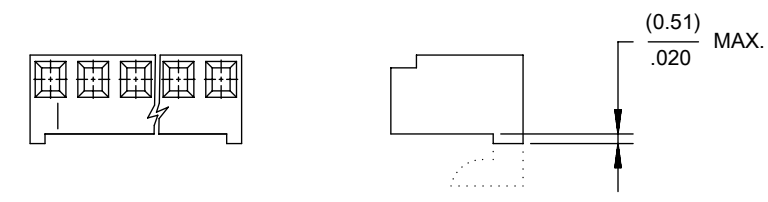
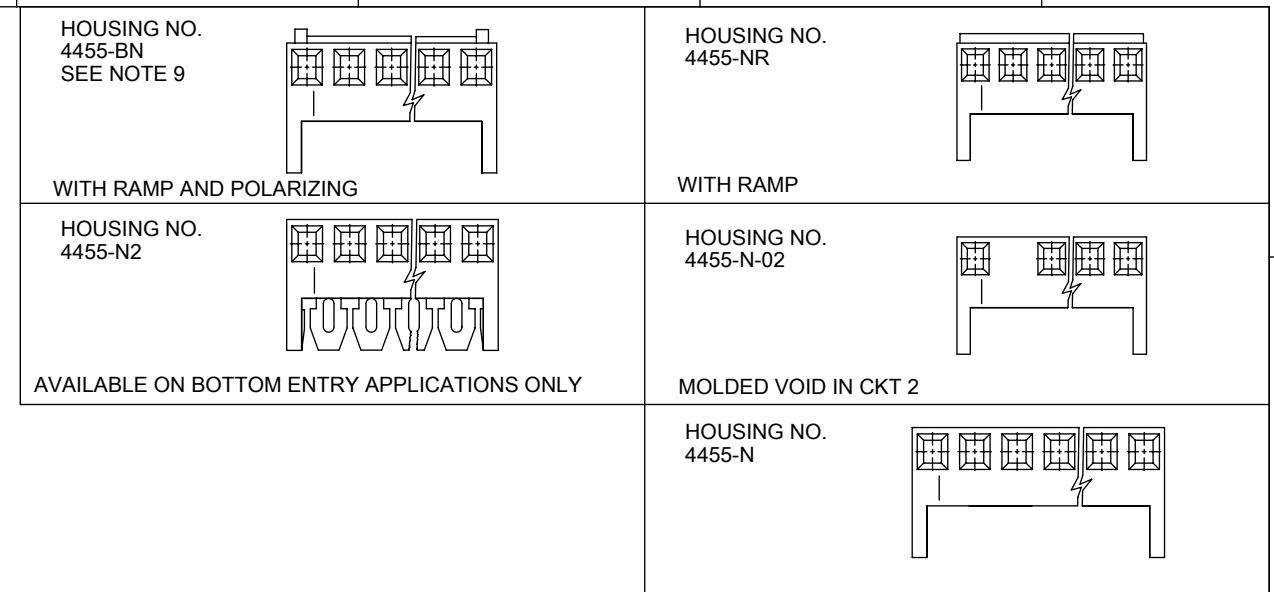

HOOKS CUT OPTION AVAILABLE ON TOP ENTRY, SEE CHART

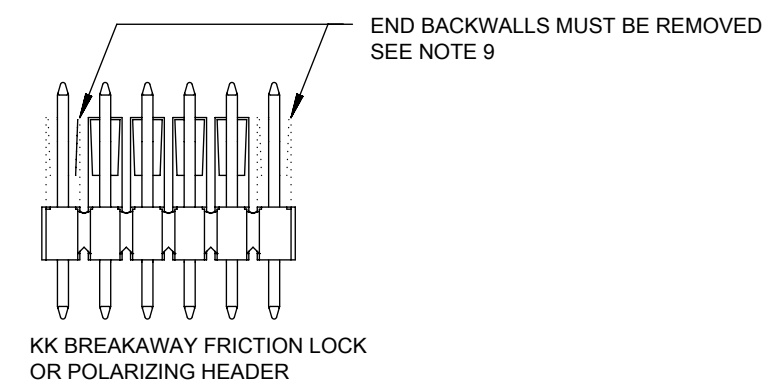

THIS DRAWING CONTAINS INFORMATION THAT IS PROPRIETARY TO MOLEX ELECTRONIC TECHNOLOGIES, LLC AND SHOULD NOT BE USED WITHOUT WRITTEN PERMISSION															
DIMENSION UNITS		SCALE		CURRENT REV DESC: REMOVED OBSOLETE PART NUMBER AS PER PCN#512128.											
MM/IN		1:1		EC NO: 716046 DRWN: SANTHN CHKD: GGA APPR: GGA INITIAL REVISION: DRWN: SAMIEC APPR: LENZ											
GENERAL TOLERANCES (UNLESS SPECIFIED)										2022/07/22		2022/07/29		2022/07/29	
										2022/07/22		2022/07/29		2022/07/29	
4 PLACES		±								±		±		±	
3 PLACES		±								±		±		±	
2 PLACES		±								±		±		±	
1 PLACE		±		±		±		±							
0 PLACES		±		±		±		±							
ANGULAR TOL				±		±		±							
ANGULAR TOL				±		±		±							
DRAFT WHERE APPLICABLE MUST REMAIN WITHIN DIMENSIONS				THIRD ANGLE PROJECTION		DRAWING		SERIES							
				B-SIZE		4455		MATERIAL NUMBER							
				SEE CHART		GENERAL MARKET		CUSTOMER							
								SHEET NUMBER							
								1 OF 15							

**molex**

KK 100 PCB ASSY  
4455 SERIES DWG

PRODUCT CUSTOMER DRAWING

DOCUMENT NUMBER: SDA-4455  
DOC TYPE: PSD  
DOC PART: 001  
REVISION: D18

# KK 100 PCB ASSY 2-25 CKT 4455 SERIES

A-4455- \* \* N \* \* - \*

ASSY PROCEDURE  
 A=RIGHT ANGLE  
 B=BOTTOM ENTRY  
 C=TOP ENTRY

HOUSING OPTION

- A=4455-AN
- B=4455-BN
- E=4455-NHH
- G=4455-BN (HOOKS CUT OFF)
- H=4455-N2 (BOTTOM ENTRY ONLY)
- P=4455-NR (HOOKS CUT OFF)
- R=4455-NR
- V=4455-N-02
- W=4455-N-02 (HOOKS CUT OFF)
- Y=4455-N (HOOKS CUT OFF)
- Z=4455-N

NO OF CIRCUITS

TERMINAL TYPE

Code	Number	Material	Form
A	4316-4	Brass	Standard
B	6516-4	Phos Bronze	Standard
C	6516-5C	Phos Bronze	Cat Ear / V
D	4316-3B	Brass	Std / V
F	6516-6C	Phos Bronze	Cat Ear / V
G	4316-3	Brass	Standard
J	6516-3B	Phos Bronze	Std / V
L	6516-3C	Phos Bronze	Cat Ear / V
M	6516-4A	Phos Bronze	Cat Ear
T	4316-4A	Brass	Cat Ear

PLATING

(SEE SHEET 1)

VOID LOCATION  
 NUMBER = CIRCUIT VOIDED  
 MULTIPLE VOIDS START  
 WITH 51  
 BLANK = NONE

Ckts	Assy Proc:	RIGHT ANGLE	Assy Proc:	RIGHT ANGLE
		Hooks Cut:	NO	Hooks Cut:
	Housing No:	4455-N	Housing No:	4455-N
	Terminal No:	4316-4(P909)	Terminal No:	4316-4(565)
	Dim C:	3.35 / .132	Dim C:	3.35 / .132
	Plating:	P909	Plating:	565
	Packaging:	PK-44646-001	Packaging:	PK-44646-001
	Voids:	NONE	Voids:	NONE
Material No	Engineer Number	Material No	Engineer Number	
2	22-15-2026	A-4455-AZ02A(P909)	22-16-2021	A-4455-AZ02A(565)
3	22-15-2036	A-4455-AZ03A(P909)	22-16-2031	A-4455-AZ03A(565)
4	22-15-2046	A-4455-AZ04A(P909)	22-16-2041	A-4455-AZ04A(565)
5	22-15-2056	A-4455-AZ05A(P909)	22-16-2051	A-4455-AZ05A(565)
6	22-15-2066	A-4455-AZ06A(P909)	22-16-2061	A-4455-AZ06A(565)
7	22-15-2076	A-4455-AZ07A(P909)	22-16-2071	A-4455-AZ07A(565)
8	22-15-2086	A-4455-AZ08A(P909)	22-16-2081	A-4455-AZ08A(565)
9	22-15-2096	A-4455-AZ09A(P909)	22-16-2091	A-4455-AZ09A(565)
10	22-15-2106	A-4455-AZ10A(P909)	22-16-2101	A-4455-AZ10A(565)
11	22-15-2116	A-4455-AZ11A(P909)	22-16-2111	A-4455-AZ11A(565)
12	22-15-2126	A-4455-AZ12A(P909)	22-16-2121	A-4455-AZ12A(565)
13	22-15-2136	A-4455-AZ13A(P909)	22-16-2131	A-4455-AZ13A(565)
14	22-15-2146	A-4455-AZ14A(P909)	22-16-2141	A-4455-AZ14A(565)
15	22-15-2156	A-4455-AZ15A(P909)	22-16-2151	A-4455-AZ15A(565)
16	22-15-2166	A-4455-AZ16A(P909)	22-16-2161	A-4455-AZ16A(565)
17	22-15-2176	A-4455-AZ17A(P909)	22-16-2171	A-4455-AZ17A(565)
18	22-15-2186	A-4455-AZ18A(P909)	22-16-2181	A-4455-AZ18A(565)
19	22-15-2196	A-4455-AZ19A(P909)	22-16-2191	A-4455-AZ19A(565)
20	22-15-2206	A-4455-AZ20A(P909)	22-16-2201	A-4455-AZ20A(565)
21				
22				
23				
24				
25				

THIS DRAWING CONTAINS INFORMATION THAT IS PROPRIETARY TO MOLEX ELECTRONIC TECHNOLOGIES, LLC AND SHOULD NOT BE USED WITHOUT WRITTEN PERMISSION											
DIMENSION UNITS <b>MM/IN</b>		SCALE <b>1:1</b>		CURRENT REV DESC: REMOVED OBSOLETE PART NUMBER AS PER PCN#512128.				molex			
GENERAL TOLERANCES (UNLESS SPECIFIED)				EC NO: 716046 DRWN: SANTHN CHKD: GGA APPR: GGA INITIAL REVISION: DRWN: SAMIEC APPR: LENZ				KK 100 PCB ASSY 4455 SERIES DWG			
4 PLACES ±		±						2022/07/22			
3 PLACES ±		± 0.01						2022/07/29			
2 PLACES ±		± 0.25 ± 0.015						2022/07/29			
1 PLACE ±		± 0.36 ±						1984/05/10 1984/05/10			
0 PLACES ±		±									
ANGULAR TOL ± 0.5°				THIRD ANGLE PROJECTION		DRAWING		SERIES		DOCUMENT NUMBER	
DRAFT WHERE APPLICABLE MUST REMAIN WITHIN DIMENSIONS				B-SIZE		4455		SEE CHART		PSD 001 D18	
DOCUMENT STATUS				P1		RELEASE DATE		2022/07/29		12:32:02	
				9		8		7		6	
				5		4		3		2	
				1							

# KK 100 PCB ASSY 2-25 CKT 4455 SERIES

STANDARD PRODUCT

Ckts	Assy Proc: RIGHT ANGLE		Assy Proc: BOTTOM ENTRY		Assy Proc: BOTTOM ENTRY		Assy Proc: BOTTOM ENTRY	
	Material No	Engineer Number	Material No	Engineer Number	Material No	Engineer Number	Material No	Engineer Number
2	22-16-2020	A-4455-AZ02A(208)	22-14-2024	A-4455-BH02D(P909)	22-17-2022	A-4455-BH02D(565)	22-17-3022	A-4455-BH02D(208)
3	22-16-2030	A-4455-AZ 03 A(208)	22-14-2034	A-4455-BH 03 D(P909)	22-17-2032	A-4455-BH 03 D(565)	22-17-3032	A-4455-BH 03 D(208)
4	22-16-2040	A-4455-AZ 04 A(208)	22-14-2044	A-4455-BH 04 D(P909)	22-17-2042	A-4455-BH 04 D(565)	22-17-3042	A-4455-BH 04 D(208)
5	22-16-2050	A-4455-AZ 05 A(208)	22-14-2054	A-4455-BH 05 D(P909)	22-17-2052	A-4455-BH 05 D(565)	22-17-3052	A-4455-BH 05 D(208)
6	22-16-2060	A-4455-AZ 06 A(208)	22-14-2064	A-4455-BH 06 D(P909)	22-17-2062	A-4455-BH 06 D(565)	22-17-3062	A-4455-BH 06 D(208)
7	22-16-2070	A-4455-AZ 07 A(208)	22-14-2074	A-4455-BH 07 D(P909)	22-17-2072	A-4455-BH 07 D(565)	22-17-3072	A-4455-BH 07 D(208)
8	22-16-2080	A-4455-AZ 08 A(208)	22-14-2084	A-4455-BH 08 D(P909)	22-17-2082	A-4455-BH 08 D(565)	22-17-3082	A-4455-BH 08 D(208)
9	22-16-2090	A-4455-AZ 09 A(208)	22-14-2094	A-4455-BH 09 D(P909)	22-17-2092	A-4455-BH 09 D(565)	22-17-3092	A-4455-BH 09 D(208)
10	22-16-2100	A-4455-AZ 10 A(208)	22-14-2104	A-4455-BH 10 D(P909)	22-17-2102	A-4455-BH 10 D(565)	22-17-3102	A-4455-BH 10 D(208)
11	22-16-2110	A-4455-AZ 11 A(208)	22-14-2114	A-4455-BH 11 D(P909)	22-17-2112	A-4455-BH 11 D(565)	22-17-3112	A-4455-BH 11 D(208)
12	22-16-2120	A-4455-AZ 12 A(208)	22-14-2124	A-4455-BH 12 D(P909)	22-17-2122	A-4455-BH 12 D(565)	22-17-3122	A-4455-BH 12 D(208)
13	22-16-2130	A-4455-AZ 13 A(208)	22-14-2134	A-4455-BH 13 D(P909)	22-17-2132	A-4455-BH 13 D(565)	22-17-3132	A-4455-BH 13 D(208)
14	22-16-2140	A-4455-AZ 14 A(208)	22-14-2144	A-4455-BH 14 D(P909)	22-17-2142	A-4455-BH 14 D(565)	22-17-3142	A-4455-BH 14 D(208)
15	22-16-2150	A-4455-AZ 15 A(208)	22-14-2154	A-4455-BH 15 D(P909)	22-17-2152	A-4455-BH 15 D(565)	22-17-3152	A-4455-BH 15 D(208)
16	22-16-2160	A-4455-AZ 16 A(208)	22-14-2164	A-4455-BH 16 D(P909)	22-17-2162	A-4455-BH 16 D(565)	22-17-3162	A-4455-BH 16 D(208)
17	22-16-2170	A-4455-AZ 17 A(208)	22-14-2174	A-4455-BH 17 D(P909)	22-17-2172	A-4455-BH 17 D(565)	22-17-3172	A-4455-BH 17 D(208)
18	22-16-2180	A-4455-AZ 18 A(208)	22-14-2184	A-4455-BH 18 D(P909)			22-17-3182	A-4455-BH 18 D(208)
19	22-16-2190	A-4455-AZ 19 A(208)	22-14-2194	A-4455-BH 19 D(P909)			22-17-3192	A-4455-BH 19 D(208)
20	22-16-2200	A-4455-AZ 20 A(208)	22-14-2204	A-4455-BH 20 D(P909)	22-17-2202	A-4455-BH 20 D(565)	22-17-3202	A-4455-BH 20 D(208)
21								
22								
23	22-16-2230	A-4455-AZ 23 A(208)						
24								
25								

THIS DRAWING CONTAINS INFORMATION THAT IS PROPRIETARY TO MOLEX ELECTRONIC TECHNOLOGIES, LLC AND SHOULD NOT BE USED WITHOUT WRITTEN PERMISSION											
DIMENSION UNITS <b>MM/IN</b>		SCALE <b>1:1</b>		CURRENT REV DESC: REMOVED OBSOLETE PART NUMBER AS PER PCN#512128.				molex			
GENERAL TOLERANCES (UNLESS SPECIFIED)						EC NO: 716046		KK 100 PCB ASSY 4455 SERIES DWG			
4 PLACES ±     ±						DRWN: SANTHN					
3 PLACES ±     ± 0.01						2022/07/22		PRODUCT CUSTOMER DRAWING			
2 PLACES ± 0.25 ± 0.015						CHKD: GGA		DOCUMENT NUMBER    DOC TYPE    DOC PART    REVISION			
1 PLACE ± 0.36 ±						APPR: GGA		<b>SDA-4455</b> PSD    001    D18			
0 PLACES ±     ±						INITIAL REVISION:		MATERIAL NUMBER    CUSTOMER			
ANGULAR TOL ± 0.5°						DRWN: SAMIEC		SEE CHART    GENERAL MARKET			
DRAFT WHERE APPLICABLE MUST REMAIN WITHIN DIMENSIONS						APPR: LENZ		SHEET NUMBER			
THIRD ANGLE PROJECTION				DRAWING		SERIES		3 OF 15			
				B-SIZE		4455					

# KK 100 PCB ASSY 2-25 CKT 4455 SERIES

Ckts	Assy Proc: TOP ENTRY		Assy Proc: TOP ENTRY		Assy Proc: TOP ENTRY		Assy Proc: RIGHT ANGLE	
	Material No	Engineer Number	Material No	Engineer Number	Material No	Engineer Number	Material No	Engineer Number
2	22-02-2025	A-4455-CZ02A(P909)	22-18-2023	A-4455-CZ02A(565)	22-18-2021	A-4455-CZ02A(208)	22-15-4025	A-4455-AZ02B(P909)
3	22-02-2035	A-4455-CZ 03A(P909)	22-18-2033	A-4455-CZ 03 A(565)	22-18-2031	A-4455-CZ 03 A(208)	22-15-4035	A-4455-AZ 03B(P909)
4	22-02-2045	A-4455-CZ 04A(P909)	22-18-2043	A-4455-CZ 04 A(565)	22-18-2041	A-4455-CZ 04 A(208)	22-15-4045	A-4455-AZ 04B(P909)
5	22-02-2055	A-4455-CZ 05A(P909)	22-18-2053	A-4455-CZ 05 A(565)	22-18-2051	A-4455-CZ 05 A(208)	22-15-4055	A-4455-AZ 05B(P909)
6	22-02-2065	A-4455-CZ 06A(P909)	22-18-2063	A-4455-CZ 06 A(565)	22-18-2061	A-4455-CZ 06 A(208)	22-15-4065	A-4455-AZ 06B(P909)
7	22-02-2075	A-4455-CZ 07A(P909)	22-18-2073	A-4455-CZ 07 A(565)	22-18-2071	A-4455-CZ 07 A(208)	22-15-4075	A-4455-AZ 07B(P909)
8	22-02-2085	A-4455-CZ 08 A(P909)	22-18-2083	A-4455-CZ 08 A(565)	22-18-2081	A-4455-CZ 08 A(208)	22-15-4085	A-4455-AZ 08B(P909)
9	22-02-2095	A-4455-CZ 09 A(P909)	22-18-2093	A-4455-CZ 09 A(565)	22-18-2091	A-4455-CZ 09 A(208)	22-15-4095	A-4455-AZ 09B(P909)
10	22-02-2105	A-4455-CZ 10 A(P909)	22-18-2103	A-4455-CZ 10 A(565)	22-18-2101	A-4455-CZ 10 A(208)	22-15-4105	A-4455-AZ 10B(P909)
11	22-02-2115	A-4455-CZ 11 A(P909)	22-18-2113	A-4455-CZ 11 A(565)	22-18-2111	A-4455-CZ 11 A(208)	22-15-4115	A-4455-AZ 11B(P909)
12	22-02-2125	A-4455-CZ 12 A(P909)	22-18-2123	A-4455-CZ 12 A(565)	22-18-2121	A-4455-CZ 12 A(208)	22-15-4125	A-4455-AZ 12B(P909)
13	22-02-2135	A-4455-CZ 13 A(P909)	22-18-2133	A-4455-CZ 13 A(565)	22-18-2131	A-4455-CZ 13 A(208)	22-15-4135	A-4455-AZ 13B(P909)
14	22-02-2145	A-4455-CZ 14 A(P909)	22-18-2143	A-4455-CZ 14 A(565)	22-18-2141	A-4455-CZ 14 A(208)	22-15-4145	A-4455-AZ 14B(P909)
15	22-02-2155	A-4455-CZ 15 A(P909)			22-18-2151	A-4455-CZ 15 A(208)	22-15-4155	A-4455-AZ 15B(P909)
16	22-02-2165	A-4455-CZ 16 A(P909)			22-18-2161	A-4455-CZ 16 A(208)	22-15-4165	A-4455-AZ 16B(P909)
17	22-02-2175	A-4455-CZ 17 A(P909)			22-18-2171	A-4455-CZ 17 A(208)	22-15-4175	A-4455-AZ 17B(P909)
18	22-02-2185	A-4455-CZ 18 A(P909)	22-18-2183	A-4455-CZ 18 A(565)	22-18-2181	A-4455-CZ 18 A(208)	22-15-4185	A-4455-AZ 18B(P909)
19	22-02-2195	A-4455-CZ 19 A(P909)			22-18-2191	A-4455-CZ 19 A(208)	22-15-4195	A-4455-AZ 19B(P909)
20	22-02-2205	A-4455-CZ 20 A(P909)	22-18-2203	A-4455-CZ 20 A(565)	22-18-2201	A-4455-CZ 20 A(208)	22-15-4205	A-4455-AZ 20B(P909)
21							22-15-4215	A-4455-AZ 21B(P909)
22							22-15-4225	A-4455-AZ 22B(P909)
23							22-15-4235	A-4455-AZ 23B(P909)
24							22-15-4245	A-4455-AZ 24B(P909)
25							22-15-4255	A-4455-AZ 25B(P909)

THIS DRAWING CONTAINS INFORMATION THAT IS PROPRIETARY TO MOLEX ELECTRONIC TECHNOLOGIES, LLC AND SHOULD NOT BE USED WITHOUT WRITTEN PERMISSION												
DIMENSION UNITS <b>MM/IN</b>		SCALE <b>1:1</b>		CURRENT REV DESC: REMOVED OBSOLETE PART NUMBER AS PER PCN#512128.				molex				
GENERAL TOLERANCES (UNLESS SPECIFIED)						EC NO: 716046		KK 100 PCB ASSY 4455 SERIES DWG				
4 PLACES ± 0.25 ± 0.015						DRWN: SANTHN 2022/07/22						
3 PLACES ± 0.25 ± 0.015						CHKD: GGA 2022/07/29		PRODUCT CUSTOMER DRAWING				
2 PLACES ± 0.25 ± 0.015						APPR: GGA 2022/07/29		DOCUMENT NUMBER				
1 PLACE ± 0.36 ± 0.015						INITIAL REVISION:		SDA-4455		DOC TYPE	DOC PART	REVISION
0 PLACES ± 0.36 ± 0.015						DRWN: SAMIEC 1984/05/10		PSD		001	D18	
ANGULAR TOL ± 0.5°						APPR: LENZ 1984/05/10		MATERIAL NUMBER		CUSTOMER		SHEET NUMBER
DRAFT WHERE APPLICABLE MUST REMAIN WITHIN DIMENSIONS						THIRD ANGLE PROJECTION		DRAWING	SERIES	SEE CHART		GENERAL MARKET
								B-SIZE	4455	4 OF 15		

# KK 100 PCB ASSY 2-25 CKT

## 4455 SERIES

Ckts	Assy Proc: RIGHT ANGLE		Assy Proc: RIGHT ANGLE		Assy Proc: BOTTOM ENTRY		Assy Proc: BOTTOM ENTRY	
	Material No	Engineer Number	Material No	Engineer Number	Material No	Engineer Number	Material No	Engineer Number
2	22-16-2024	A-4455-AZ02B(565)			22-17-2021	A-4455-BH02J(565)		
3	22-16-2034	A-4455-AZ 03 B(565)			22-17-2031	A-4455-BH 03 J(565)		
4	22-16-2044	A-4455-AZ 04 B(565)			22-17-2041	A-4455-BH 04 J(565)		
5	22-16-2054	A-4455-AZ 05 B(565)			22-17-2051	A-4455-BH 05 J(565)		
6	22-16-2064	A-4455-AZ 06 B(565)			22-17-2061	A-4455-BH 06 J(565)		
7	22-16-2074	A-4455-AZ 07 B(565)			22-17-2071	A-4455-BH 07 J(565)		
8	22-16-2084	A-4455-AZ 08 B(565)			22-17-2081	A-4455-BH 08 J(565)		
9	22-16-2094	A-4455-AZ 09 B(565)			22-17-2091	A-4455-BH 09 J(565)		
10	22-16-2104	A-4455-AZ 10 B(565)			22-17-2101	A-4455-BH 10 J(565)		
11	22-16-2114	A-4455-AZ 11 B(565)			22-17-2111	A-4455-BH 11 J(565)		
12	22-16-2124	A-4455-AZ 12 B(565)			22-17-2121	A-4455-BH 12 J(565)		
13	22-16-2134	A-4455-AZ 13 B(565)			22-17-2131	A-4455-BH 13 J(565)		
14	22-16-2144	A-4455-AZ 14 B(565)			22-17-2141	A-4455-BH 14 J(565)		
15	22-16-2154	A-4455-AZ 15 B(565)			22-17-2151	A-4455-BH 15 J(565)		
16	22-16-2164	A-4455-AZ 16 B(565)			22-17-2161	A-4455-BH 16 J(565)		
17	22-16-2174	A-4455-AZ 17 B(565)			22-17-2171	A-4455-BH 17 J(565)		
18	22-16-2184	A-4455-AZ 18 B(565)			22-17-2181	A-4455-BH 18 J(565)		
19	22-16-2194	A-4455-AZ 19 B(565)			22-17-2191	A-4455-BH 19 J(565)		
20	22-16-2204	A-4455-AZ 20 B(565)			22-17-2201	A-4455-BH 20 J(565)		
21	22-16-2214	A-4455-AZ 21 B(565)			22-17-2211	A-4455-BH 21 J(565)		
22	22-16-2224	A-4455-AZ 22 B(565)			22-17-2221	A-4455-BH 22 J(565)		
23	22-16-2234	A-4455-AZ 23 B(565)			22-17-2231	A-4455-BH 23 J(565)		
24	22-16-2244	A-4455-AZ 24 B(565)			22-17-2241	A-4455-BH 24 J(565)		
25					22-17-2251	A-4455-BH 25 J(565)		

THIS DRAWING CONTAINS INFORMATION THAT IS PROPRIETARY TO MOLEX ELECTRONIC TECHNOLOGIES, LLC AND SHOULD NOT BE USED WITHOUT WRITTEN PERMISSION											
DIMENSION UNITS	SCALE	CURRENT REV DESC: REMOVED OBSOLETE PART NUMBER AS PER PCN#512128.			molex						
MM/IN	1:1										
GENERAL TOLERANCES (UNLESS SPECIFIED)		EC NO: 716046 DRWN: SANTHN 2022/07/22 CHKD: GGA 2022/07/29 APPR: GGA 2022/07/29			KK 100 PCB ASSY 4455 SERIES DWG						
					PRODUCT CUSTOMER DRAWING						
4 PLACES	±						DOCUMENT NUMBER: <b>SDA-4455</b> DOC TYPE: PSD DOC PART: 001 REVISION: D18				
3 PLACES	±					0.01					
2 PLACES	±				0.25	± 0.015					
1 PLACE	±	0.36	±								
0 PLACES	±			INITIAL REVISION: DRWN: SAMIEC 1984/05/10 APPR: LENZ 1984/05/10							
ANGULAR TOL ± 0.5°		THIRD ANGLE PROJECTION			DRAWING		SERIES		SHEET NUMBER		
DRAFT WHERE APPLICABLE MUST REMAIN WITHIN DIMENSIONS					B-SIZE		4455		SEE CHART		
DOCUMENT STATUS		P1	RELEASE DATE		2022/07/29 12:32:02		GENERAL MARKET		5 OF 15		

# KK 100 PCB ASSY 2-25 CKT 4455 SERIES

Ckts	Assy Proc: TOP ENTRY		Assy Proc: TOP ENTRY		Assy Proc: TOP ENTRY		Assy Proc: RIGHT ANGLE	
	Material No	Engineer Number	Material No	Engineer Number	Material No	Engineer Number	Material No	Engineer Number
2			22-18-2022	A-4455-CZ02B(565)				
3			22-18-2032	A-4455-CZ 03 B(565)				
4			22-18-2042	A-4455-CZ 04 B(565)				
5			22-18-2052	A-4455-CZ 05 B(565)				
6			22-18-2062	A-4455-CZ 06 B(565)				
7			22-18-2072	A-4455-CZ 07 B(565)			22-15-2075	A-4455-AA07A(P909)
8			22-18-2082	A-4455-CZ 08 B(565)			22-15-2085	A-4455-AA 08A(P909)
9			22-18-2092	A-4455-CZ 09 B(565)			22-15-2095	A-4455-AA 09A(P909)
10			22-18-2102	A-4455-CZ 10 B(565)			22-15-2105	A-4455-AA 10A(P909)
11			22-18-2112	A-4455-CZ 11 B(565)			22-15-2115	A-4455-AA 11A(P909)
12			22-18-2122	A-4455-CZ 12 B(565)				
13			22-18-2132	A-4455-CZ 13 B(565)			22-15-2135	A-4455-AA 13A(P909)
14			22-18-2142	A-4455-CZ 14 B(565)			22-15-2145	A-4455-AA 14A(P909)
15			22-18-2152	A-4455-CZ 15 B(565)			22-15-2155	A-4455-AA 15A(P909)
16			22-18-2162	A-4455-CZ 16 B(565)			22-15-2165	A-4455-AA 16A(P909)
17			22-18-2172	A-4455-CZ 17 B(565)			22-15-2175	A-4455-AA 17A(P909)
18			22-18-2182	A-4455-CZ 18 B(565)				
19			22-18-2192	A-4455-CZ 19 B(565)			22-15-2195	A-4455-AA 19A(P909)
20			22-18-2202	A-4455-CZ 20 B(565)				
21			22-18-2212	A-4455-CZ 21 B(565)			22-15-2215	A-4455-AA 21A(P909)
22			22-18-2222	A-4455-CZ 22 B(565)			22-15-2225	A-4455-AA 22A(P909)
23			22-18-2232	A-4455-CZ 23 B(565)				
24			22-18-2242	A-4455-CZ 24 B(565)			22-15-2245	A-4455-AA 24A(P909)
25			22-18-2252	A-4455-CZ 25 B(565)			22-15-2255	A-4455-AA 25A(P909)

THIS DRAWING CONTAINS INFORMATION THAT IS PROPRIETARY TO MOLEX ELECTRONIC TECHNOLOGIES, LLC AND SHOULD NOT BE USED WITHOUT WRITTEN PERMISSION													
DIMENSION UNITS <b>MM/IN</b>		SCALE <b>1:1</b>		CURRENT REV DESC: REMOVED OBSOLETE PART NUMBER AS PER PCN#512128.				<b>molex</b>					
GENERAL TOLERANCES (UNLESS SPECIFIED)				EC NO: 716046 DRWN: SANTHN 2022/07/22 CHKD: GGA 2022/07/29 APPR: GGA 2022/07/29 INITIAL REVISION: DRWN: SAMIEC 1984/05/10 APPR: LENZ 1984/05/10				KK 100 PCB ASSY 4455 SERIES DWG					
4 PLACES ±		±						PRODUCT CUSTOMER DRAWING					
3 PLACES ±		± 0.01						DOCUMENT NUMBER					
2 PLACES ± 0.25		± 0.015						<b>SDA-4455</b>		PSD	001	D18	
1 PLACE ± 0.36		±						SHEET NUMBER					
0 PLACES ±		±		SEE CHART		GENERAL MARKET		6 OF 15					
ANGULAR TOL ± 0.5°				THIRD ANGLE PROJECTION		DRAWING		SERIES		MATERIAL NUMBER			
DRAFT WHERE APPLICABLE MUST REMAIN WITHIN DIMENSIONS						<b>B-SIZE</b>		<b>4455</b>		CUSTOMER			

# KK 100 PCB ASSY 2-25 CKT

## 4455 SERIES

Ckts	Assy Proc: RIGHT ANGLE		Assy Proc: RIGHT ANGLE		Assy Proc: RIGHT ANGLE		Assy Proc: RIGHT ANGLE	
	Material No	Engineer Number	Material No	Engineer Number	Material No	Engineer Number	Material No	Engineer Number
2								
3								
4								
5								
6			50-34-8518	A-4455-AB 06 A(228)				
7								
8								
9	22-16-2096	A-4455-AA 09 A(208)						
10								
11								
12								
13								
14								
15								
16								
17								
18	22-16-2186	A-4455-AA 18 A(208)						
19	22-16-2196	A-4455-AA 19 A(208)						
20	22-16-2206	A-4455-AA 20 A(208)						
21	22-16-2216	A-4455-AA 21 A(208)						
22	22-16-2226	A-4455-AA 22 A(208)						
23	22-16-2236	A-4455-AA 23 A(208)						
24								
25								

THIS DRAWING CONTAINS INFORMATION THAT IS PROPRIETARY TO MOLEX ELECTRONIC TECHNOLOGIES, LLC AND SHOULD NOT BE USED WITHOUT WRITTEN PERMISSION																	
DIMENSION UNITS <b>MM/IN</b>		SCALE <b>1:1</b>		CURRENT REV DESC: REMOVED OBSOLETE PART NUMBER AS PER PCN#512128.				molex									
GENERAL TOLERANCES (UNLESS SPECIFIED)				EC NO: 716046 DRWN: SANTHN CHKD: GGA APPR: GGA INITIAL REVISION: DRWN: SAMIEC APPR: LENZ				KK 100 PCB ASSY 4455 SERIES DWG									
4 PLACES ±		±						2022/07/22				PRODUCT CUSTOMER DRAWING					
3 PLACES ±		± 0.01						2022/07/29				DOCUMENT NUMBER					
2 PLACES ± 0.25		± 0.015						2022/07/29				SDA-4455		DOC TYPE		DOC PART	
1 PLACE ± 0.36		±						1984/05/10				PSD		001		D18	
0 PLACES ±		±		1984/05/10				SERIES		MATERIAL NUMBER		CUSTOMER					
ANGULAR TOL ± 0.5°				THIRD ANGLE PROJECTION		DRAWING		4455		SEE CHART		GENERAL MARKET					
DRAFT WHERE APPLICABLE MUST REMAIN WITHIN DIMENSIONS				B-SIZE		7 OF 15		SHEET NUMBER									

# KK 100 PCB ASSY 2-25 CKT 4455 SERIES

Ckts	Assy Proc: RIGHT ANGLE		Assy Proc: RIGHT ANGLE		Assy Proc: RIGHT ANGLE		Assy Proc: RIGHT ANGLE	
	Material No	Engineer Number	Material No	Engineer Number	Material No	Engineer Number	Material No	Engineer Number
2	22-15-4022	A-4455-AR02A(P909)			22-17-5023	A-4455-AZ02B(228)		
3	22-15-4032	A-4455-AR 03 A(P909)			22-17-5033	A-4455-AZ 03 B(228)		
4	22-15-4042	A-4455-AR 04 A(P909)			22-17-5043	A-4455-AZ 04 B(228)		
5	22-15-4052	A-4455-AR 05 A(P909)						
6	22-15-4062	A-4455-AR 06 A(P909)			22-17-5063	A-4455-AZ 06 B(228)		
7	22-15-4072	A-4455-AR 07 A(P909)			22-17-5073	A-4455-AZ 07 B(228)		
8	22-15-4082	A-4455-AR 08 A(P909)			22-17-5083	A-4455-AZ 08 B(228)		
9	22-15-4092	A-4455-AR 09 A(P909)			22-17-5093	A-4455-AZ 09 B(228)		
10	22-15-4102	A-4455-AR 10 A(P909)			22-17-5103	A-4455-AZ 10 B(228)		
11	22-15-4112	A-4455-AR 11 A(P909)			22-17-5113	A-4455-AZ 11 B(228)		
12	22-15-4122	A-4455-AR 12 A(P909)			22-17-5123	A-4455-AZ 12 B(228)		
13	22-15-4132	A-4455-AR 13 A(P909)			22-17-5133	A-4455-AZ 13 B(228)		
14	22-15-4142	A-4455-AR 14 A(P909)			22-17-5143	A-4455-AZ 14 B(228)		
15	22-15-4152	A-4455-AR 15 A(P909)			22-17-5153	A-4455-AZ 15 B(228)		
16	22-15-4162	A-4455-AR 16 A(P909)			22-17-5163	A-4455-AZ 16 B(228)		
17	22-15-4172	A-4455-AR 17 A(P909)			22-17-5173	A-4455-AZ 17 B(228)		
18	22-15-4182	A-4455-AR 18 A(P909)			22-17-5183	A-4455-AZ 18 B(228)		
19	22-15-4192	A-4455-AR 19 A(P909)			22-17-5193	A-4455-AZ 19 B(228)		
20	22-15-4202	A-4455-AR 20 A(P909)	22-17-5201	A-4455-AZ 20 A(228)	22-17-5203	A-4455-AZ 20 B(228)		
21	22-15-4212	A-4455-AR 21 A(P909)			22-17-5213	A-4455-AZ 21 B(228)		
22	22-15-4222	A-4455-AR 22 A(P909)			22-17-5223	A-4455-AZ 22 B(228)		
23	22-15-4232	A-4455-AR 23 A(P909)			22-17-5233	A-4455-AZ 23 B(228)		
24	22-15-4242	A-4455-AR 24 A(P909)			22-17-5243	A-4455-AZ 24 B(228)		
25	22-15-4252	A-4455-AR 25 A(P909)			22-17-5253	A-4455-AZ 25 B(228)		

THIS DRAWING CONTAINS INFORMATION THAT IS PROPRIETARY TO MOLEX ELECTRONIC TECHNOLOGIES, LLC AND SHOULD NOT BE USED WITHOUT WRITTEN PERMISSION																													
DIMENSION UNITS: <b>MM/IN</b> SCALE: <b>1:1</b>		CURRENT REV DESC: REMOVED OBSOLETE PART NUMBER AS PER PCN#512128.																											
GENERAL TOLERANCES (UNLESS SPECIFIED)		EC NO: 716046 DRWN: SANTHN CHKD: GGA APPR: GGA			KK 100 PCB ASSY 4455 SERIES DWG																								
<table border="1" style="width: 100%; border-collapse: collapse;"> <tr> <th></th> <th>MM</th> <th>INCH</th> </tr> <tr> <td>4 PLACES ±</td> <td></td> <td></td> </tr> <tr> <td>3 PLACES ±</td> <td></td> <td>± 0.01</td> </tr> <tr> <td>2 PLACES ±</td> <td>0.25</td> <td>± 0.015</td> </tr> <tr> <td>1 PLACE ±</td> <td>0.36</td> <td></td> </tr> <tr> <td>0 PLACES ±</td> <td></td> <td></td> </tr> </table>			MM	INCH	4 PLACES ±			3 PLACES ±		± 0.01	2 PLACES ±	0.25	± 0.015	1 PLACE ±	0.36		0 PLACES ±			2022/07/22 2022/07/29 2022/07/29			PRODUCT CUSTOMER DRAWING						
	MM	INCH																											
4 PLACES ±																													
3 PLACES ±		± 0.01																											
2 PLACES ±	0.25	± 0.015																											
1 PLACE ±	0.36																												
0 PLACES ±																													
ANGULAR TOL ± 0.5°		INITIAL REVISION: DRWN: SAMIEC APPR: LENZ			1984/05/10 1984/05/10		DOCUMENT NUMBER: <b>SDA-4455</b>		DOC TYPE: PSD	DOC PART: 001	REVISION: D18																		
DRAFT WHERE APPLICABLE MUST REMAIN WITHIN DIMENSIONS		THIRD ANGLE PROJECTION	DRAWING: B-SIZE	SERIES: 4455	MATERIAL NUMBER: SEE CHART	CUSTOMER: GENERAL MARKET		SHEET NUMBER: 8 OF 15																					



# KK 100 PCB ASSY 2-25 CKT 4455 SERIES

Ckts	Assy Proc: BOTTOM ENTRY		Assy Proc: BOTTOM ENTRY		Assy Proc: BOTTOM ENTRY		Assy Proc: BOTTOM ENTRY	
	Material No	Engineer Number	Material No	Engineer Number	Material No	Engineer Number	Material No	Engineer Number
2	22-17-2024	A-4455-BH02D(228)					22-17-2027	A-4455-BH02J(228)
3	22-17-2034	A-4455-BH03D(228)					22-17-2037	A-4455-BH03J(228)
4	22-17-2044	A-4455-BH04D(228)					22-17-2047	A-4455-BH04J(228)
5	22-17-2054	A-4455-BH05D(228)			22-17-3056	A-4455-BH05D(228)	22-17-2057	A-4455-BH05J(228)
6	22-17-2064	A-4455-BH06D(228)			22-17-3066	A-4455-BH06D(228)	22-17-2067	A-4455-BH06J(228)
7	22-17-2074	A-4455-BH07D(228)					22-17-2077	A-4455-BH07J(228)
8	22-17-2084	A-4455-BH08D(228)			22-17-3086	A-4455-BH08D(228)	22-17-2087	A-4455-BH08J(228)
9	22-17-2094	A-4455-BH09D(228)					22-17-2097	A-4455-BH09J(228)
10	22-17-2104	A-4455-BH10D(228)					22-17-2107	A-4455-BH10J(228)
11	22-17-2114	A-4455-BH11D(228)					22-17-2117	A-4455-BH11J(228)
12	22-17-2124	A-4455-BH12D(228)					22-17-2127	A-4455-BH12J(228)
13	22-17-2134	A-4455-BH13D(228)					22-17-2137	A-4455-BH13J(228)
14	22-17-2144	A-4455-BH14D(228)	22-17-2140	A-4455-BH 14 D(231)	22-17-3146	A-4455-BH14D(228)	22-17-2147	A-4455-BH14J(228)
15							22-17-2157	A-4455-BH15J(228)
16	22-17-2164	A-4455-BH16D(228)					22-17-2167	A-4455-BH16J(228)
17							22-17-2177	A-4455-BH17J(228)
18	22-17-2184	A-4455-BH18D(228)					22-17-2187	A-4455-BH18J(228)
19	22-17-2194	A-4455-BH19D(228)			22-17-3196	A-4455-BH19D(228)	22-17-2197	A-4455-BH19J(228)
20	22-17-2204	A-4455-BH20D(228)	22-17-2200	A-4455-BH 20 D(231)	22-17-3206	A-4455-BH20D(228)	22-17-2207	A-4455-BH20J(228)
21	22-17-2214	A-4455-BH21D(228)						
22	22-17-2224	A-4455-BH22D(228)						
23	22-17-2234	A-4455-BH23D(228)						
24	22-17-2244	A-4455-BH24D(228)						
25	22-17-2254	A-4455-BH25D(228)	22-17-2250	A-4455-BH 25 D(231)	22-17-3256	A-4455-BH25D(228)		

THIS DRAWING CONTAINS INFORMATION THAT IS PROPRIETARY TO MOLEX ELECTRONIC TECHNOLOGIES, LLC AND SHOULD NOT BE USED WITHOUT WRITTEN PERMISSION																											
DIMENSION UNITS <b>MM/IN</b>	SCALE <b>1:1</b>	CURRENT REV DESC: REMOVED OBSOLETE PART NUMBER AS PER PCN#512128.			molex																						
GENERAL TOLERANCES (UNLESS SPECIFIED)					KK 100 PCB ASSY 4455 SERIES DWG																						
<table border="1" style="width: 100%; border-collapse: collapse;"> <tr> <th></th> <th>MM</th> <th>INCH</th> </tr> <tr> <td>4 PLACES ±</td> <td></td> <td></td> </tr> <tr> <td>3 PLACES ±</td> <td></td> <td>± 0.01</td> </tr> <tr> <td>2 PLACES ±</td> <td>± 0.25</td> <td>± 0.015</td> </tr> <tr> <td>1 PLACE ±</td> <td>± 0.36</td> <td></td> </tr> <tr> <td>0 PLACES ±</td> <td></td> <td></td> </tr> </table>						MM	INCH	4 PLACES ±			3 PLACES ±		± 0.01	2 PLACES ±	± 0.25	± 0.015	1 PLACE ±	± 0.36		0 PLACES ±			EC NO: 716046 DRWN: SANTHN 2022/07/22 CHKD: GGA 2022/07/29 APPR: GGA 2022/07/29				
	MM	INCH																									
4 PLACES ±																											
3 PLACES ±		± 0.01																									
2 PLACES ±	± 0.25	± 0.015																									
1 PLACE ±	± 0.36																										
0 PLACES ±																											
DRAFT WHERE APPLICABLE MUST REMAIN WITHIN DIMENSIONS					THIRD ANGLE PROJECTION 		DRAWING	SERIES	MATERIAL NUMBER	CUSTOMER																	
		<b>B-SIZE</b>	<b>4455</b>	SEE CHART	GENERAL MARKET		SHEET NUMBER	9 OF 15																			

# KK 100 PCB ASSY 2-25 CKT 4455 SERIES

Ckts	Assy Proc: TOP ENTRY		Assy Proc: TOP ENTRY		Assy Proc: TOP ENTRY		Assy Proc: TOP ENTRY	
		Hooks Cut:	YES	Hooks Cut:	YES	Hooks Cut:	YES	Hooks Cut:
	Housing No:	4455-NR	Housing No:	4455-N	Housing No:	4455-N	Housing No:	4455-BN
	Terminal No:	4316-4(208)	Terminal No:	4316-4(565)	Terminal No:	4316-4(P909)	Terminal No:	4316-4(P909)
	Dim C:	3.35 / .132	Dim C:	3.35 / .132	Dim C:	3.35 / .132	Dim C:	3.35 / .132
	Plating:	208	Plating:	565	Plating:	P909	Plating:	P909
	Packaging:	PK-44646-003	Packaging:	PK-44646-003	Packaging:	PK-44646-003	Packaging:	PK-44646-002
	Voids:	NO	Voids:	NO	Voids:	NO	Voids:	NO
	Material No	Engineer Number	Material No	Engineer Number	Material No	Engineer Number	Material No	Engineer Number
2			22-18-2026	A-4455-CY02A(565)	22-02-7023	A-4455-CY02A(P909)	22-15-4028	A-4455-CB02A(P909)
3			22-18-2036	A-4455-CY 03 A(565)	22-02-7033	A-4455-CY 03A(P909)	22-15-4038	A-4455-CB 03A(P909)
4			22-18-2046	A-4455-CY 04 A(565)	22-02-7043	A-4455-CY 04A(P909)	22-15-4048	A-4455-CB 04A(P909)
5	22-18-2057	A-4455-CP 05 A(208)			22-02-7053	A-4455-CY 05A(P909)	22-15-4058	A-4455-CB 05A(P909)
6			22-18-2066	A-4455-CY 06 A(565)	22-02-7063	A-4455-CY 06A(P909)	22-15-4068	A-4455-CB 06A(P909)
7					22-02-7073	A-4455-CY 07A(P909)	22-15-4078	A-4455-CB 07A(P909)
8					22-02-7083	A-4455-CY 08A(P909)	22-15-4088	A-4455-CB 08A(P909)
9					22-02-7093	A-4455-CY 09A(P909)	22-15-4098	A-4455-CB 09A(P909)
10					22-02-7103	A-4455-CY 10A(P909)	22-15-4108	A-4455-CB 10A(P909)
11					22-02-7113	A-4455-CY 11A(P909)	22-15-4118	A-4455-CB 11A(P909)
12			22-18-2126	A-4455-CY 12 A(565)	22-02-7123	A-4455-CY 12A(P909)	22-15-4128	A-4455-CB 12A(P909)
13					22-02-7133	A-4455-CY 13A(P909)	22-15-4138	A-4455-CB 13A(P909)
14			22-18-2146	A-4455-CY 14 A(565)	22-02-7143	A-4455-CY 14A(P909)	22-15-4148	A-4455-CB 14A(P909)
15			22-18-2156	A-4455-CY 15 A(565)	22-02-7153	A-4455-CY 15A(P909)	22-15-4158	A-4455-CB 15A(P909)
16			22-18-2166	A-4455-CY 16 A(565)	22-02-7163	A-4455-CY 16A(P909)	22-15-4168	A-4455-CB 16A(P909)
17			22-18-2176	A-4455-CY 17 A(565)	22-02-7173	A-4455-CY 17A(P909)	22-15-4178	A-4455-CB 17A(P909)
18			22-18-2186	A-4455-CY 18 A(565)	22-02-7183	A-4455-CY 18A(P909)		
19			22-18-2196	A-4455-CY 19 A(565)	22-02-7193	A-4455-CY 19A(P909)	22-15-4198	A-4455-CB 19A(P909)
20			22-18-2206	A-4455-CY 20 A(565)	22-02-7203	A-4455-CY 20A(P909)	22-15-4208	A-4455-CB 20A(P909)
21			22-18-2216	A-4455-CY 21 A(565)	22-02-7213	A-4455-CY 21A(P909)	22-15-4218	A-4455-CB 21A(P909)
22			22-18-2226	A-4455-CY 22 A(565)	22-02-7223	A-4455-CY 22A(P909)	22-15-4228	A-4455-CB 22A(P909)
23			22-18-2236	A-4455-CY 23 A(565)	22-02-7233	A-4455-CY 23A(P909)	22-15-4238	A-4455-CB 23A(P909)
24			22-18-2246	A-4455-CY 24 A(565)			22-15-4248	A-4455-CB 24A(P909)
25			22-18-2256	A-4455-CY 25 A(565)			22-15-4258	A-4455-CB 25A(P909)

THIS DRAWING CONTAINS INFORMATION THAT IS PROPRIETARY TO MOLEX ELECTRONIC TECHNOLOGIES, LLC AND SHOULD NOT BE USED WITHOUT WRITTEN PERMISSION											
DIMENSION UNITS <b>MM/IN</b>		SCALE <b>1:1</b>		CURRENT REV DESC: REMOVED OBSOLETE PART NUMBER AS PER PCN#512128.				molex			
GENERAL TOLERANCES (UNLESS SPECIFIED)						EC NO: 716046		KK 100 PCB ASSY 4455 SERIES DWG			
		MM		INCH		DRWN: SANTHN					
4 PLACES ±		±		±		2022/07/22					
3 PLACES ±		±		0.01		2022/07/29					
2 PLACES ±		0.25		±		0.015		2022/07/29		PRODUCT CUSTOMER DRAWING	
1 PLACE ±		0.36		±		INITIAL REVISION:		DOCUMENT NUMBER			
0 PLACES ±		±		±		DRWN: SAMIEC		1984/05/10		SDA-4455	
ANGULAR TOL ±		0.5°		±		APPR: LENZ		1984/05/10		PSD 001 D18	
DRAFT WHERE APPLICABLE MUST REMAIN WITHIN DIMENSIONS				THIRD ANGLE PROJECTION		DRAWING		SERIES		MATERIAL NUMBER	
						B-SIZE		4455		SEE CHART	
								CUSTOMER		SHEET NUMBER	
								GENERAL MARKET		10 OF 15	

# KK 100 PCB ASSY 2-25 CKT 4455 SERIES

Ckts	Assy Proc: TOP ENTRY		Assy Proc: TOP ENTRY		Assy Proc: TOP ENTRY		Assy Proc: TOP ENTRY	
	Material No	Engineer Number	Material No	Engineer Number	Material No	Engineer Number	Material No	Engineer Number
2	22-65-3020	A-4455-CR02A(P909)			22-18-7023	A-4455-CY02A(208)	22-18-7021	A-4455-CY02B(228)
3	22-65-3030	A-4455-CR 03A(P909)			22-18-7033	A-4455-CY 03 A(208)	22-18-7031 38-00-1478	A-4455-CY 03 B(228)
4	22-65-3040	A-4455-CR 04A(P909)			22-18-7043	A-4455-CY 04 A(208)	22-18-7041	A-4455-CY 04 B(228)
5	22-65-3050	A-4455-CR 05A(P909)			22-18-7053	A-4455-CY 05 A(208)	22-18-7051	A-4455-CY 05 B(228)
6	22-65-3060	A-4455-CR 06A(P909)			22-18-7063	A-4455-CY 06 A(208)	22-18-7061	A-4455-CY 06 B(228)
7	22-65-3070	A-4455-CR 07A(P909)			22-18-7073	A-4455-CY 07 A(208)	22-18-7071	A-4455-CY 07 B(228)
8	22-65-3080	A-4455-CR 08A(P909)			22-18-7083	A-4455-CY 08 A(208)	22-18-7081	A-4455-CY 08 B(228)
9	22-65-3090	A-4455-CR 09A(P909)			22-18-7093	A-4455-CY 09 A(208)	22-18-7091	A-4455-CY 09 B(228)
10	22-65-3100	A-4455-CR 10A(P909)			22-18-7103	A-4455-CY 10 A(208)	22-18-7101	A-4455-CY 10 B(228)
11	22-65-3110	A-4455-CR 11A(P909)			22-18-7113	A-4455-CY 11 A(208)	22-18-7111	A-4455-CY 11 B(228)
12	22-65-3120	A-4455-CR 12A(P909)	22-18-2124	A-4455-CZ 12 B(228)	22-18-7123	A-4455-CY 12 A(208)	22-18-7121	A-4455-CY 12 B(228)
13	22-65-3130	A-4455-CR 13A(P909)			22-18-7133	A-4455-CY 13 A(208)	22-18-7131	A-4455-CY 13 B(228)
14	22-65-3140	A-4455-CR 14A(P909)			22-18-7143	A-4455-CY 14 A(208)	22-18-7141	A-4455-CY 14 B(228)
15	22-65-3150	A-4455-CR 15A(P909)			22-18-7153	A-4455-CY 15 A(208)	22-18-7151	A-4455-CY 15 B(228)
16	22-65-3160	A-4455-CR 16A(P909)	22-18-2164	A-4455-CZ 16 B(228)	22-18-7163	A-4455-CY 16 A(208)	22-18-7161	A-4455-CY 16 B(228)
17	22-65-3170	A-4455-CR 17A(P909)			22-18-7173	A-4455-CY 17 A(208)	22-18-7171	A-4455-CY 17 B(228)
18	22-65-3180	A-4455-CR 18A(P909)			22-18-7183	A-4455-CY 18 A(208)	22-18-7181	A-4455-CY 18 B(228)
19	22-65-3190	A-4455-CR 19A(P909)	22-18-2194	A-4455-CZ 19 B(228)	22-18-7193	A-4455-CY 19 A(208)	22-18-7191	A-4455-CY 19 B(228)
20	22-65-3200	A-4455-CR 20A(P909)			22-18-7203	A-4455-CY 20 A(208)	22-18-7201	A-4455-CY 20 B(228)
21	22-65-3210	A-4455-CR 21A(P909)			22-18-7213	A-4455-CY 21 A(208)	22-18-7211	A-4455-CY 21 B(228)
22	22-65-3220	A-4455-CR 22A(P909)			22-18-7223	A-4455-CY 22 A(208)	22-18-7221	A-4455-CY 22 B(228)
23	22-65-3230	A-4455-CR 23A(P909)			22-18-7233	A-4455-CY 23 A(208)	22-18-7231	A-4455-CY 23 B(228)
24	22-65-3240	A-4455-CR 24A(P909)			22-18-7243	A-4455-CY 24 A(208)		
25	22-65-3250	A-4455-CR 25A(P909)			22-18-7253	A-4455-CY 25 A(208)	22-18-7251	A-4455-CY 25 B(228)

THIS DRAWING CONTAINS INFORMATION THAT IS PROPRIETARY TO MOLEX ELECTRONIC TECHNOLOGIES, LLC AND SHOULD NOT BE USED WITHOUT WRITTEN PERMISSION									
DIMENSION UNITS <b>MM/IN</b>	SCALE <b>1:1</b>	CURRENT REV DESC: REMOVED OBSOLETE PART NUMBER AS PER PCN#512128.			molex				
GENERAL TOLERANCES (UNLESS SPECIFIED)		EC NO: 716046			KK 100 PCB ASSY 4455 SERIES DWG				
4 PLACES ± 0.25 ± 0.015		DRWN: SANTHN 2022/07/22							
3 PLACES ± 0.25 ± 0.015		CHKD: GGA 2022/07/29			PRODUCT CUSTOMER DRAWING				
2 PLACES ± 0.25 ± 0.015		APPR: GGA 2022/07/29			DOCUMENT NUMBER		DOC TYPE	DOC PART	REVISION
1 PLACE ± 0.36 ± 0.015		INITIAL REVISION:			SDA-4455		PSD	001	D18
0 PLACES ± 0.36 ± 0.015		DRWN: SAMIEC 1984/05/10							
ANGULAR TOL ± 0.5°		APPR: LENZ 1984/05/10			MATERIAL NUMBER		CUSTOMER		SHEET NUMBER
DRAFT WHERE APPLICABLE MUST REMAIN WITHIN DIMENSIONS		THIRD ANGLE PROJECTION		DRAWING	SERIES	SEE CHART		GENERAL MARKET	
				B-SIZE	4455			11 OF 15	

# KK 100 PCB ASSY 2-25 CKT 4455 SERIES

Ckts	Assy Proc: RIGHT ANGLE		Assy Proc: BOTTOM ENTRY		Assy Proc: RIGHT ANGLE		Assy Proc: RIGHT ANGLE	
	Material No	Engineer Number	Material No	Engineer Number	Material No	Engineer Number	Material No	Engineer Number
2	38-00-1332	A-4455-AZ02C(P909)	38-00-1392	A-4455-BH02F(P909)				
3	38-00-1333	A-4455-AZ03C(P909)	38-00-1393	A-4455-BH03F(P909)				
4	38-00-1334	A-4455-AZ04C(P909)	38-00-1394	A-4455-BH04F(P909)				
5	38-00-1335	A-4455-AZ05C(P909)	38-00-1395	A-4455-BH05F(P909)				
6	38-00-1336	A-4455-AZ06C(P909)	38-00-1396	A-4455-BH06F(P909)				
7	38-00-1337	A-4455-AZ07C(P909)	38-00-1397	A-4455-BH07F(P909)	22-14-2079	A-4455-AA07B(P909)	22-14-2077	A-4455-AA07A(565)
8	38-00-1338	A-4455-AZ08C(P909)	38-00-1398	A-4455-BH08F(P909)	22-14-2089	A-4455-AA 08 B(P909)	22-14-2087	A-4455-AA 08 A(565)
9	38-00-1339	A-4455-AZ09C(P909)	38-00-1399	A-4455-BH09F(P909)	22-14-2099	A-4455-AA 09 B(P909)	22-14-2097	A-4455-AA 09 A(565)
10	38-00-1340	A-4455-AZ10C(P909)	38-00-1400	A-4455-BH10F(P909)	22-14-2109	A-4455-AA 10 B(P909)	22-14-2107	A-4455-AA 10 A(565)
11	38-00-1341	A-4455-AZ11C(P909)	38-00-1401	A-4455-BH11F(P909)	22-14-2119	A-4455-AA 11 B(P909)	22-14-2117	A-4455-AA 11 A(565)
12	38-00-1342	A-4455-AZ12C(P909)	38-00-1402	A-4455-BH12F(P909)	22-14-2129	A-4455-AA 12 B(P909)	22-14-2127	A-4455-AA 12 A(565)
13	38-00-1343	A-4455-AZ13C(P909)	38-00-1403	A-4455-BH13F(P909)	22-14-2139	A-4455-AA 13 B(P909)	22-14-2137	A-4455-AA 13 A(565)
14	38-00-1344	A-4455-AZ14C(P909)	38-00-1404	A-4455-BH14F(P909)	22-14-2149	A-4455-AA 14 B(P909)	22-14-2147	A-4455-AA 14 A(565)
15	38-00-1345	A-4455-AZ15C(P909)	38-00-1405	A-4455-BH15F(P909)	22-14-2159	A-4455-AA 15 B(P909)	22-14-2157	A-4455-AA 15 A(565)
16	38-00-1346	A-4455-AZ16C(P909)	38-00-1406	A-4455-BH16F(P909)	22-14-2169	A-4455-AA 16 B(P909)	22-14-2167	A-4455-AA 16 A(565)
17	38-00-1347	A-4455-AZ17C(P909)	38-00-1407	A-4455-BH17F(P909)	22-14-2179	A-4455-AA 17 B(P909)	22-14-2177	A-4455-AA 17 A(565)
18	38-00-1348	A-4455-AZ18C(P909)	38-00-1408	A-4455-BH18F(P909)	22-14-2189	A-4455-AA 18 B(P909)	22-14-2187	A-4455-AA 18 A(565)
19	38-00-1349	A-4455-AZ19C(P909)	38-00-1409	A-4455-BH19F(P909)	22-14-2199	A-4455-AA 19 B(P909)	22-14-2197	A-4455-AA 19 A(565)
20	38-00-1350	A-4455-AZ20C(P909)	38-00-1410	A-4455-BH20F(P909)	22-14-2209	A-4455-AA 20 B(P909)	22-14-2207	A-4455-AA 20 A(565)
21					22-14-2219	A-4455-AA 21 B(P909)	22-14-2217	A-4455-AA 21 A(565)
22					22-14-2229	A-4455-AA 22 B(P909)	22-14-2227	A-4455-AA 22 A(565)
23					22-14-2239	A-4455-AA 23 B(P909)	22-14-2237	A-4455-AA 23 A(565)
24					22-14-2249	A-4455-AA 24 B(P909)	22-14-2247	A-4455-AA 24 A(565)
25					22-14-2259	A-4455-AA 25 B(P909)	22-14-2257	A-4455-AA 25 A(565)

THIS DRAWING CONTAINS INFORMATION THAT IS PROPRIETARY TO MOLEX ELECTRONIC TECHNOLOGIES, LLC AND SHOULD NOT BE USED WITHOUT WRITTEN PERMISSION												
DIMENSION UNITS <b>MM/IN</b>		SCALE <b>1:1</b>		CURRENT REV DESC: REMOVED OBSOLETE PART NUMBER AS PER PCN#512128.				molex				
GENERAL TOLERANCES (UNLESS SPECIFIED)						EC NO: 716046		KK 100 PCB ASSY 4455 SERIES DWG				
4 PLACES ± 0.25 ± 0.015						DRWN: SANTHN 2022/07/22						
3 PLACES ± 0.25 ± 0.015						CHKD: GGA 2022/07/29		PRODUCT CUSTOMER DRAWING				
2 PLACES ± 0.25 ± 0.015						APPR: GGA 2022/07/29		DOCUMENT NUMBER				
1 PLACE ± 0.36 ± 0.015						INITIAL REVISION:		SDA-4455		DOC TYPE	DOC PART	REVISION
0 PLACES ± 0.36 ± 0.015						DRWN: SAMIEC 1984/05/10		PSD		001	D18	
ANGULAR TOL ± 0.5°						APPR: LENZ 1984/05/10		MATERIAL NUMBER		CUSTOMER		SHEET NUMBER
DRAFT WHERE APPLICABLE MUST REMAIN WITHIN DIMENSIONS						THIRD ANGLE PROJECTION		DRAWING	SERIES	SEE CHART	GENERAL MARKET	12 OF 15

# KK 100 PCB ASSY 2-25 CKT

## 4455 SERIES

Ckts	Assy Proc: RIGHT ANGLE		Assy Proc: RIGHT ANGLE		Assy Proc: TOP ENTRY		Assy Proc: TOP ENTRY	
	Material No	Engineer Number	Material No	Engineer Number	Material No	Engineer Number	Material No	Engineer Number
2			22-16-3028	A-4455-AB02A(565)	38-00-1422	A-4455-CZ02C(P909)		
3			22-16-3038	A-4455-AB 03 A(565)	38-00-1423	A-4455-CZ03C(P909)		
4			22-16-3048	A-4455-AB 04 A(565)	38-00-1424	A-4455-CZ04C(P909)		
5			22-16-3058	A-4455-AB 05 A(565)	38-00-1425	A-4455-CZ05C(P909)		
6			22-16-3068	A-4455-AB 06 A(565)	38-00-1426	A-4455-CZ06C(P909)	22-02-3068	A-4455-CW06A(P909)-2
7	22-14-3617	A-4455-AA07T(P909)	22-16-3078	A-4455-AB 07 A(565)	38-00-1427	A-4455-CZ07C(P909)	50-29-0004	A-4455-CW07A(P909)-2
8	22-14-3618	A-4455-AA 08 T(P909)	22-16-3088	A-4455-AB 08 A(565)	38-00-1428	A-4455-CZ08C(P909)		
9	22-14-3619	A-4455-AA 09 T(P909)	22-16-3098	A-4455-AB 09 A(565)	38-00-1429	A-4455-CZ09C(P909)		
10	22-14-3711	A-4455-AA 10 T(P909)	22-16-3108	A-4455-AB 10 A(565)	38-00-1430	A-4455-CZ10C(P909)		
11	22-14-3712	A-4455-AA 11 T(P909)	22-16-3118	A-4455-AB 11 A(565)	38-00-1431	A-4455-CZ11C(P909)		
12	22-14-3713	A-4455-AA 12 T(P909)	22-16-3128	A-4455-AB 12 A(565)	38-00-1432	A-4455-CZ12C(P909)		
13	22-14-3714	A-4455-AA 13 T(P909)	22-16-3138	A-4455-AB 13 A(565)	38-00-1433	A-4455-CZ13C(P909)		
14	22-14-3715	A-4455-AA 14 T(P909)	22-16-3148	A-4455-AB 14 A(565)	38-00-1434	A-4455-CZ14C(P909)		
15	22-14-3716	A-4455-AA 15 T(P909)	22-16-3158	A-4455-AB 15 A(565)	38-00-1435	A-4455-CZ15C(P909)		
16	22-14-3717	A-4455-AA 16 T(P909)	22-16-3168	A-4455-AB 16 A(565)	38-00-1436	A-4455-CZ16C(P909)		
17	22-14-3718	A-4455-AA 17 T(P909)	22-16-3178	A-4455-AB 17 A(565)	38-00-1437	A-4455-CZ17C(P909)		
18	22-14-3719	A-4455-AA 18 T(P909)	22-16-3188	A-4455-AB 18 A(565)	38-00-1438	A-4455-CZ18C(P909)		
19	22-14-3811	A-4455-AA 19 T(P909)	22-16-3198	A-4455-AB 19 A(565)	38-00-1439	A-4455-CZ19C(P909)		
20	22-14-3812	A-4455-AA 20 T(P909)	22-16-3208	A-4455-AB 20 A(565)	38-00-1440	A-4455-CZ20C(P909)		
21	22-14-3813	A-4455-AA 21 T(P909)	22-16-3218	A-4455-AB 21 A(565)				
22	22-14-3814	A-4455-AA 22 T(P909)	22-16-3228	A-4455-AB 22 A(565)				
23	22-14-3815	A-4455-AA 23 T(P909)	22-16-3238	A-4455-AB 23 A(565)				
24	22-14-3816	A-4455-AA 24 T(P909)	22-16-3248	A-4455-AB 24 A(565)				
25			22-16-3258	A-4455-AB 25 A(565)				

THIS DRAWING CONTAINS INFORMATION THAT IS PROPRIETARY TO MOLEX ELECTRONIC TECHNOLOGIES, LLC AND SHOULD NOT BE USED WITHOUT WRITTEN PERMISSION											
DIMENSION UNITS	SCALE	CURRENT REV DESC: REMOVED OBSOLETE PART NUMBER AS PER PCN#512128.					molex				
MM/IN	1:1										
GENERAL TOLERANCES (UNLESS SPECIFIED)		EC NO: 716046 DRWN: SANTHN 2022/07/22 CHKD: GGA 2022/07/29 APPR: GGA 2022/07/29					PRODUCT CUSTOMER DRAWING				
	MM INCH										
4 PLACES	± 0.25 ± 0.015										
3 PLACES	± 0.25 ± 0.015										
2 PLACES	± 0.25 ± 0.015										
1 PLACE	± 0.36 ± 0.015	INITIAL REVISION: DRWN: SAMIEC 1984/05/10 APPR: LENZ 1984/05/10					DOCUMENT NUMBER	DOC TYPE	DOC PART	REVISION	
ANGULAR TOL	± 0.5°	THIRD ANGLE PROJECTION					DRAWING	SERIES	MATERIAL NUMBER	CUSTOMER	SHEET NUMBER
DRAFT WHERE APPLICABLE MUST REMAIN WITHIN DIMENSIONS							B-SIZE	4455	SEE CHART	GENERAL MARKET	13 OF 15

# KK 100 PCB ASSY 2-25 CKT 4455 SERIES

Ckts	Assy Proc: TOP ENTRY		Assy Proc: TOP ENTRY		Assy Proc: BOTTOM ENTRY		Assy Proc: BOTTOM ENTRY	
	Material No	Engineer Number	Material No	Engineer Number	Material No	Engineer Number	Material No	Engineer Number
2								
3								
4								
5	50-29-1553	A-4455-CY 05B(P909)						
6	50-29-1554	A-4455-CY 06B(P909)	22-15-5065	A-4455-CY06A(P909)-2				
7								
8								
9								
10								
11					50-36-1881	A-4455-BH11D(P909)-10		
12								
13							26-01-3099	A-4455-BH13D(208)-51
14								
15								
16								
17								
18								
19								
20								
21								
22								
23								
24								
25								

THIS DRAWING CONTAINS INFORMATION THAT IS PROPRIETARY TO MOLEX ELECTRONIC TECHNOLOGIES, LLC AND SHOULD NOT BE USED WITHOUT WRITTEN PERMISSION									
<small>DIMENSION UNITS</small> <b>MM/IN</b>		<small>SCALE</small> <b>1:1</b>		<small>CURRENT REV DESC: REMOVED OBSOLETE PART NUMBER AS PER PCN#512128.</small>					
<small>GENERAL TOLERANCES (UNLESS SPECIFIED)</small>				<small>EC NO:</small> 716046		<small>DRWN:</small> SANTHN		<small>2022/07/22</small>	
<small>4 PLACES</small> ±		<small>MM</small>		<small>INCH</small>		<small>CHKD:</small> GGA		<small>2022/07/29</small>	
<small>3 PLACES</small> ±		<small>MM</small>		<small>INCH</small>		<small>APPR:</small> GGA		<small>2022/07/29</small>	
<small>2 PLACES</small> ±		<small>MM</small>		<small>INCH</small>		<small>INITIAL REVISION:</small>		<small>DOCUMENT NUMBER</small>	
<small>1 PLACE</small> ±		<small>MM</small>		<small>INCH</small>		<small>DRWN:</small> SAMIEC		<small>SDA-4455</small>	
<small>0 PLACES</small> ±		<small>MM</small>		<small>INCH</small>		<small>APPR:</small> LENZ		<small>PSD 001 D18</small>	
<small>ANGULAR TOL</small> ±		<small>MM</small>		<small>INCH</small>		<small>1984/05/10</small>		<small>DOC TYPE</small>	
<small>ANGULAR TOL</small> ±		<small>MM</small>		<small>INCH</small>		<small>1984/05/10</small>		<small>DOC PART</small>	
<small>ANGULAR TOL</small> ±		<small>MM</small>		<small>INCH</small>		<small>1984/05/10</small>		<small>REVISION</small>	
<small>ANGULAR TOL</small> ±		<small>MM</small>		<small>INCH</small>		<small>1984/05/10</small>		<small>REVISION</small>	
<small>ANGULAR TOL</small> ±		<small>MM</small>		<small>INCH</small>		<small>1984/05/10</small>		<small>REVISION</small>	
<small>ANGULAR TOL</small> ±		<small>MM</small>		<small>INCH</small>		<small>1984/05/10</small>		<small>REVISION</small>	
<small>ANGULAR TOL</small> ±		<small>MM</small>		<small>INCH</small>		<small>1984/05/10</small>		<small>REVISION</small>	
<small>ANGULAR TOL</small> ±		<small>MM</small>		<small>INCH</small>		<small>1984/05/10</small>		<small>REVISION</small>	
<small>ANGULAR TOL</small> ±		<small>MM</small>		<small>INCH</small>		<small>1984/05/10</small>		<small>REVISION</small>	
<small>ANGULAR TOL</small> ±		<small>MM</small>		<small>INCH</small>		<small>1984/05/10</small>		<small>REVISION</small>	
<small>ANGULAR TOL</small> ±		<small>MM</small>		<small>INCH</small>		<small>1984/05/10</small>		<small>REVISION</small>	
<small>ANGULAR TOL</small> ±		<small>MM</small>		<small>INCH</small>		<small>1984/05/10</small>		<small>REVISION</small>	
<small>ANGULAR TOL</small> ±		<small>MM</small>		<small>INCH</small>		<small>1984/05/10</small>		<small>REVISION</small>	
<small>ANGULAR TOL</small> ±		<small>MM</small>		<small>INCH</small>		<small>1984/05/10</small>		<small>REVISION</small>	
<small>ANGULAR TOL</small> ±		<small>MM</small>		<small>INCH</small>		<small>1984/05/10</small>		<small>REVISION</small>	
<small>ANGULAR TOL</small> ±		<small>MM</small>		<small>INCH</small>		<small>1984/05/10</small>		<small>REVISION</small>	
<small>ANGULAR TOL</small> ±		<small>MM</small>		<small>INCH</small>		<small>1984/05/10</small>		<small>REVISION</small>	
<small>ANGULAR TOL</small> ±		<small>MM</small>		<small>INCH</small>		<small>1984/05/10</small>		<small>REVISION</small>	
<small>ANGULAR TOL</small> ±		<small>MM</small>		<small>INCH</small>		<small>1984/05/10</small>		<small>REVISION</small>	
<small>ANGULAR TOL</small> ±		<small>MM</small>		<small>INCH</small>		<small>1984/05/10</small>		<small>REVISION</small>	
<small>ANGULAR TOL</small> ±		<small>MM</small>		<small>INCH</small>		<small>1984/05/10</small>		<small>REVISION</small>	
<small>ANGULAR TOL</small> ±		<small>MM</small>		<small>INCH</small>		<small>1984/05/10</small>		<small>REVISION</small>	
<small>ANGULAR TOL</small> ±		<small>MM</small>		<small>INCH</small>		<small>1984/05/10</small>		<small>REVISION</small>	
<small>ANGULAR TOL</small> ±		<small>MM</small>		<small>INCH</small>		<small>1984/05/10</small>		<small>REVISION</small>	
<small>ANGULAR TOL</small> ±		<small>MM</small>		<small>INCH</small>		<small>1984/05/10</small>		<small>REVISION</small>	
<small>ANGULAR TOL</small> ±		<small>MM</small>		<small>INCH</small>		<small>1984/05/10</small>		<small>REVISION</small>	
<small>ANGULAR TOL</small> ±		<small>MM</small>		<small>INCH</small>		<small>1984/05/10</small>		<small>REVISION</small>	
<small>ANGULAR TOL</small> ±		<small>MM</small>		<small>INCH</small>		<small>1984/05/10</small>		<small>REVISION</small>	
<small>ANGULAR TOL</small> ±		<small>MM</small>		<small>INCH</small>		<small>1984/05/10</small>		<small>REVISION</small>	
<small>ANGULAR TOL</small> ±		<small>MM</small>		<small>INCH</small>		<small>1984/05/10</small>		<small>REVISION</small>	
<small>ANGULAR TOL</small> ±		<small>MM</small>		<small>INCH</small>		<small>1984/05/10</small>		<small>REVISION</small>	
<small>ANGULAR TOL</small> ±		<small>MM</small>		<small>INCH</small>		<small>1984/05/10</small>		<small>REVISION</small>	
<small>ANGULAR TOL</small> ±		<small>MM</small>		<small>INCH</small>		<small>1984/05/10</small>		<small>REVISION</small>	
<small>ANGULAR TOL</small> ±		<small>MM</small>		<small>INCH</small>		<small>1984/05/10</small>		<small>REVISION</small>	
<small>ANGULAR TOL</small> ±		<small>MM</small>		<small>INCH</small>		<small>1984/05/10</small>		<small>REVISION</small>	
<small>ANGULAR TOL</small> ±		<small>MM</small>		<small>INCH</small>		<small>1984/05/10</small>		<small>REVISION</small>	
<small>ANGULAR TOL</small> ±		<small>MM</small>		<small>INCH</small>		<small>1984/05/10</small>		<small>REVISION</small>	
<small>ANGULAR TOL</small> ±		<small>MM</small>		<small>INCH</small>		<small>1984/05/10</small>		<small>REVISION</small>	
<small>ANGULAR TOL</small> ±		<small>MM</small>		<small>INCH</small>		<small>1984/05/10</small>		<small>REVISION</small>	
<small>ANGULAR TOL</small> ±		<small>MM</small>		<small>INCH</small>		<small>1984/05/10</small>		<small>REVISION</small>	
<small>ANGULAR TOL</small> ±		<small>MM</small>		<small>INCH</small>		<small>1984/05/10</small>		<small>REVISION</small>	
<small>ANGULAR TOL</small> ±		<small>MM</small>		<small>INCH</small>		<small>1984/05/10</small>		<small>REVISION</small>	
<small>ANGULAR TOL</small> ±		<small>MM</small>		<small>INCH</small>		<small>1984/05/10</small>		<small>REVISION</small>	
<small>ANGULAR TOL</small> ±		<small>MM</small>		<small>INCH</small>		<small>1984/05/10</small>		<small>REVISION</small>	
<small>ANGULAR TOL</small> ±		<small>MM</small>		<small>INCH</small>		<small>1984/05/10</small>		<small>REVISION</small>	
<small>ANGULAR TOL</small> ±		<small>MM</small>		<small>INCH</small>		<small>1984/05/10</small>		<small>REVISION</small>	
<small>ANGULAR TOL</small> ±		<small>MM</small>		<small>INCH</small>		<small>1984/05/10</small>		<small>REVISION</small>	
<small>ANGULAR TOL</small> ±		<small>MM</small>		<small>INCH</small>		<small>1984/05/10</small>		<small>REVISION</small>	
<small>ANGULAR TOL</small> ±		<small>MM</small>		<small>INCH</small>		<small>1984/05/10</small>		<small>REVISION</small>	
<small>ANGULAR TOL</small> ±		<small>MM</small>		<small>INCH</small>		<small>1984/05/10</small>		<small>REVISION</small>	
<small>ANGULAR TOL</small> ±		<small>MM</small>		<small>INCH</small>		<small>1984/05/10</small>		<small>REVISION</small>	
<small>ANGULAR TOL</small> ±		<small>MM</small>		<small>INCH</small>		<small>1984/05/10</small>		<small>REVISION</small>	
<small>ANGULAR TOL</small> ±		<small>MM</small>		<small>INCH</small>		<small>1984/05/10</small>		<small>REVISION</small>	
<small>ANGULAR TOL</small> ±		<small>MM</small>		<small>INCH</small>		<small>1984/05/10</small>		<small>REVISION</small>	
<small>ANGULAR TOL</small> ±		<small>MM</small>		<small>INCH</small>		<small>1984/05/10</small>		<small>REVISION</small>	
<small>ANGULAR TOL</small> ±		<small>MM</small>		<small>INCH</small>		<small>1984/05/10</small>		<small>REVISION</small>	
<small>ANGULAR TOL</small> ±		<small>MM</small>		<small>INCH</small>		<small>1984/05/10</small>		<small>REVISION</small>	
<small>ANGULAR TOL</small> ±		<small>MM</small>		<small>INCH</small>		<small>1984/05/10</small>		<small>REVISION</small>	
<small>ANGULAR TOL</small> ±		<small>MM</small>		<small>INCH</small>		<small>1984/05/10</small>		<small>REVISION</small>	
<small>ANGULAR TOL</small> ±		<small>MM</small>		<small>INCH</small>		<small>1984/05/10</small>		<small>REVISION</small>	
<small>ANGULAR TOL</small> ±		<small>MM</small>		<small>INCH</small>		<small>1984/05/10</small>		<small>REVISION</small>	
<small>ANGULAR TOL</small> ±		<small>MM</small>		<small>INCH</small>		<small>1984/05/10</small>		<small>REVISION</small>	
<small>ANGULAR TOL</small> ±		<small>MM</small>		<small>INCH</small>		<small>1984/05/10</small>		<small>REVISION</small>	
<small>ANGULAR TOL</small> ±		<small>MM</small>		<small>INCH</small>		<small>1984/05/10</small>		<small>REVISION</small>	
<small>ANGULAR TOL</small> ±		<small>MM</small>		<small>INCH</small>		<small>1984/05/10</small>		<small>REVISION</small>	
<small>ANGULAR TOL</small> ±		<small>MM</small>		<small>INCH</small>		<small>1984/05/10</small>		<small>REVISION</small>	
<small>ANGULAR TOL</small> ±		<small>MM</small>		<small>INCH</small>		<small>1984/05/10</small>		<small>REVISION</small>	
<small>ANGULAR TOL</small> ±		<small>MM</small>		<small>INCH</small>		<small>1984/05/10</small>		<small>REVISION</small>	
<small>ANGULAR TOL</small> ±		<small>MM</small>		<small>INCH</small>		<small>1984/05/10</small>		<small>REVISION</small>	
<small>ANGULAR TOL</small> ±		<small>MM</small>		<small>INCH</small>		<small>1984/05/10</small>		<small>REVISION</small>	
<small>ANGULAR TOL</small> ±		<small>MM</small>		<small>INCH</small>		<small>1984/05/10</small>		<small>REVISION</small>	
<small>ANGULAR TOL</small> ±		<small>MM</small>		<small>INCH</small>		<small>1984/05/10</small>		<small>REVISION</small>	
<small>ANGULAR TOL</small> ±		<small>MM</small>		<small>INCH</small>		<small>1984/05/10</small>		<small>REVISION</small>	
<small>ANGULAR TOL</small> ±		<small>MM</small>		<small>INCH</small>		<small>1984/05/10</small>		<small>REVISION</small>	
<small>ANGULAR TOL</small> ±		<small>MM</small>		<small>INCH</small>		<small>1984/05/10</small>		<small>REVISION</small>	
<small>ANGULAR TOL</small> ±		<small>MM</small>		<small>INCH</small>		<small>1984/05/10</small>		<small>REVISION</small>	
<small>ANGULAR TOL</small> ±		<small>MM</small>		<small>INCH</small>		<small>1984/05/10</small>		<small>REVISION</small>	
<small>ANGULAR TOL</small> ±		<small>MM</small>		<small>INCH</small>		<small>1984/05/10</small>		<small>REVISION</small>	
<small>ANGULAR TOL</small> ±		<small>MM</small>		<small>INCH</small>		<small>1984/05/10</small>		<small>REVISION</small>	
<small>ANGULAR TOL</small> ±		<small>MM</small>		<small>INCH</small>		<small>1984/05/10</small>		<small>REVISION</small>	
<small>ANGULAR TOL</small> ±		<small>MM</small>		<small>INCH</small>		<small>1984/05/10</small>		<small>REVISION</small>	
<small>ANGULAR TOL</small> ±		<small>MM</small>		<small>INCH</small>		<small>1984/05/10</small>		<small>REVISION</small>	
<small>ANGULAR TOL</small> ±		<small>MM</small>		<small>INCH</small>		<small>1984/05/10</small>		<small>REVISION</small>	
<small>ANGULAR TOL</small> ±		<small>MM</small>		<small>INCH</small>		<small>1984/05/10</small>		<small>REVISION</small>	
<small>ANGULAR TOL</small> ±		<small>MM</small>		<small>INCH</small>		<small>1984/05/10</small>		<small>REVISION</small>	
<small>ANGULAR TOL</small> ±		<small>MM</small>		<small>INCH</small>		<small>1984/05/10</small>		<small>REVISION</small>	
<small>ANGULAR TOL</small> ±		<small>MM</small>		<small>INCH</small>		<small>1984/05/10</small>		<small>REVISION</small>	
<small>ANGULAR TOL</small> ±		<small>MM</small>		<small>INCH</small>		<small>1984/05/10</small>		<small>REVISION</small>	
<small>ANGULAR TOL</small> ±		<small>MM</small>		<small>INCH</small>		<small>1984/05/10</small>		<small>REVISION</small>	
<small>ANGULAR TOL</small> ±		<small>MM</small>		<small>INCH</small>		<small>1984/05/10</small>		<small>REVISION</small>	
<small>ANGULAR TOL</small> ±									

# KK 100 PCB ASSY 2-25 CKT 4455 SERIES

Ckts	Material No	Engineer Number	Material No	Engineer Number	Material No	Engineer Number	Material No	Engineer Number
2								
3			46999-0585	A-4455-CG03A(P909)			22-02-2031	A-4455-CY 03A(P909)
4			46999-0583	A-4455-CG04A(P909)				
5								
6			46999-0584	A-4455-CG06A(P909)				
7								
8					46999-0599	A-4455-CP 08A(P909)		
9								
10								
11								
12								
13								
14			46999-0586	A-4455-CG14A(P909)				
15								
16								
17	46999-0582	A-4455-AB17A(P909)-51						
18								
19								
20								
21								
22								
23								
24								
25								

THIS DRAWING CONTAINS INFORMATION THAT IS PROPRIETARY TO MOLEX ELECTRONIC TECHNOLOGIES, LLC AND SHOULD NOT BE USED WITHOUT WRITTEN PERMISSION											
DIMENSION UNITS	SCALE	CURRENT REV DESC: REMOVED OBSOLETE PART NUMBER AS PER PCN#512128.						molex			
MM/IN	1:1							KK 100 PCB ASSY 4455 SERIES DWG			
GENERAL TOLERANCES (UNLESS SPECIFIED)		EC NO: 716046 DRWN: SANTHN 2022/07/22 CHKD: GGA 2022/07/29 APPR: GGA 2022/07/29						PRODUCT CUSTOMER DRAWING			
								DOCUMENT NUMBER			DOC TYPE
4 PLACES ±	±	INITIAL REVISION: DRWN: SAMIEC 1984/05/10 APPR: LENZ 1984/05/10						SDA-4455			
3 PLACES ±	± 0.01							SEE CHART			GENERAL MARKET
2 PLACES ±	0.25 ± 0.015	DRAFT WHERE APPLICABLE MUST REMAIN WITHIN DIMENSIONS						SHEET NUMBER			
1 PLACE ±	0.36 ±							THIRD ANGLE PROJECTION			DRAWING
0 PLACES ±	±	ANGULAR TOL ± 0.5°						B-SIZE 4455			
THIRD ANGLE PROJECTION								DRAWING			SERIES