

FEATURES

Full-featured evaluation board for the AD7797

Standalone USB interface

Various linking options

PC software for control of AD7797

GENERAL DESCRIPTION

This data sheet describes the evaluation board for the [AD7797](#), a low power, 24-bit sigma-delta (Σ - Δ) ADC. The AD7797 is a complete analog front end for low frequency measurement applications, such as bridge sensor systems. It contains one differential input and includes a low noise instrumentation amplifier. The update rate can be varied from 4.17 Hz to 123 Hz.

The AD7797 also has an on-board clock, eliminating the need for an external clock. It employs a Σ - Δ conversion technique to realize up to 24 bits of no missing codes performance. The input signal is applied to an analog modulator. The modulator output is processed by an on-chip digital filter. The analog input

channel of the AD7797 accepts analog input signals of $\pm V_{REF}/128$. With the update rate programmed to 4.17 Hz, the rms noise is 65 nV. Simultaneous 50 Hz/60 Hz rejection is available at an update rate of 16.7 Hz.

Full details on the AD7797 are available in the AD7797 data sheet, available from Analog Devices, Inc., which should be consulted in conjunction with this data sheet when using the evaluation board.

The evaluation board interfaces to the USB port of an IBM-compatible PC. Software is available with the evaluation board, which allows the user to communicate easily with the AD7797. Note that the AD7797 evaluation board software must be installed before connecting the AD7797 evaluation board to the PC.

Other components on the AD7797 evaluation board include the [ADP3303](#) high precision, low power, 3.3 V output voltage regulator used to power the USB/SPI interface.

FUNCTIONAL BLOCK DIAGRAM

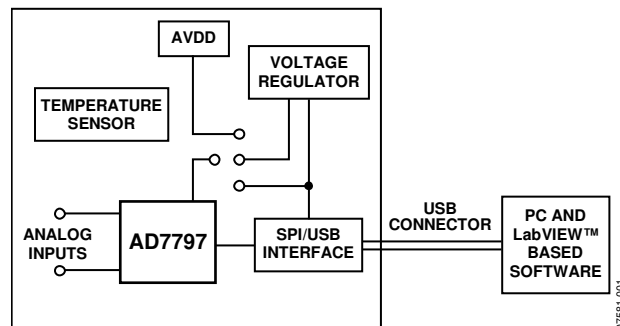

Figure 1.

Rev. 0

Evaluation boards are only intended for device evaluation and not for production purposes. Evaluation boards are supplied "as is" and without warranties of any kind, express, implied, or statutory including, but not limited to, any implied warranty of merchantability or fitness for a particular purpose. No license is granted by implication or otherwise under any patents or other intellectual property by application or use of evaluation boards. Information furnished by Analog Devices is believed to be accurate and reliable. However, no responsibility is assumed by Analog Devices for its use, nor for any infringements of patents or other rights of third parties that may result from its use. Analog Devices reserves the right to change devices or specifications at any time without notice. Trademarks and registered trademarks are the property of their respective owners. Evaluation boards are not authorized to be used in life support devices or systems.

TABLE OF CONTENTS

Features	1	Software Description	5
General Description	1	Installing the Software	5
Functional Block Diagram	1	Using the Software	5
Revision History	2	Main Window Options.....	6
Evaluation Board Hardware.....	3	Registers.....	7
Power Supplies	3	Other Registers	8
Links	3	Evaluation Board Schematic and Artwork.....	9
Setting Up the Evaluation Board.....	3	Ordering Information.....	12
Sockets	3	Bill of Materials.....	12
Interfacing to the Evaluation Board.....	4	Ordering Guide	12
Evaluation Board Software	5	ESD Caution.....	12

REVISION HISTORY

7/08—Revision 0: Initial Version

EVALUATION BOARD HARDWARE

POWER SUPPLIES

The AD7797 evaluation board is powered via the 5 V supply from the USB connector, J1. This 5 V supply can be used to power the AD7797 directly. A 3.3 V regulated voltage from the on-board ADP3303, a high precision, low power, 3.3 V output voltage regulator, can also be used. Alternatively, the AD7797 can be powered using an external 3 V or 5 V power supply via J3.

LINKS

There are five link options that must be set for the required operating setup before using the evaluation board. The functions of these link options are outlined in Table 1.

Table 1. Evaluation Board Link Settings

Link	Default Position	Description
LK1, LK2	In	These links are used to connect the AIN(+) and AIN(−) inputs to a reference voltage, which equals $AV_{DD}/2$. With these links removed, an external voltage can be applied to AIN using the SMB connectors.
LK3, LK4	In	AV_{DD} can be used as a reference for the AD7797. With LK3 and LK4 in place, AV_{DD} is connected to REFIN(+) and REFIN(−) is connected to GND. To use another reference source, remove LK3 and LK4.
LK5	B	LK5 is used to select the power source for AV_{DD} on the AD7797. LK5 in Position A selects an external power supply, supplied via J3. LK5 in Position B selects the 3.3 V regulated output from the on-board ADP3303 voltage regulator. LK5 in Position C selects the 5 V supply from the USB connector, J1.

Table 2. Initial Link and Switch Positions

Link No.	Position	Description
LK1, LK2	In	AIN(+) and AIN(−) are shorted to $AV_{DD}/2$.
LK3, LK4	In	The reference voltage is set to 3.3 V (AV_{DD}).
LK5	B	The 3.3 V supply is used as AV_{DD} for the AD7797.

Table 3. Socket Functions

Socket	Description
AIN+	Subminiature BNC (SMB) connector. The analog input signal for the AIN(+) input of the AD7797 is applied to this socket.
AIN−	Subminiature BNC (SMB) connector. The analog input signal for the AIN(−) input of the AD7797 is applied to this socket.
REFIN+	Subminiature BNC (SMB) connector. This socket is used in conjunction with REFIN− to apply an external reference to the AD7797. The voltage for the REFIN(+) input of the AD7797 is applied to this socket.
REFIN−	Subminiature BNC (SMB) connector. This socket is used in conjunction with REFIN+ to apply an external reference to the AD7797. The voltage for the REFIN(−) input of the AD7797 is applied to this socket.
J2	8-pin (2 × 4) straight header. This socket is used in conjunction with the prototype area to interface any signal to the AD7797.

SETTING UP THE EVALUATION BOARD

Care should be taken before applying power and signals to the evaluation board to ensure that all link positions are set per the required operating mode. Table 2 shows the position in which all the links are initially set.

SOCKETS

There are five sockets relevant to the operation of the AD7797 on this evaluation board. The functions of these sockets are outlined in Table 3.

EVAL-AD7797

INTERFACING TO THE EVALUATION BOARD

Interfacing to the evaluation board is via a standard USB connector, J1. J1 is used to connect the evaluation board to the USB port of a PC. A standard USB connector cable is included with the AD7797 evaluation board to allow the evaluation board to interface with the USB port of the PC. Because the board is powered via the USB connector, there is no need for an external power supply, although one can be connected if preferred, via J3.

Communication between the [AD7797](#) and the PC is via the USB/SPI interface. The on-board USB controller (U2) controls this communication.

To install the AD7797 evaluation board, use the following steps:

1. Install the AD7797 evaluation board software, using the supplied AD7797 evaluation board CD-ROM, before connecting the board to the PC.
2. When installation of the AD7797 evaluation board software is complete, use the supplied USB connector cable to connect the board to the PC via J1 on the AD7797 evaluation board and the USB port on the PC. The PC automatically detects the new USB device and identifies it as **AD779x Evaluation Board**.
3. Follow the on-screen instructions that appear automatically. During the installation process, if the **Hardware Installation** window appears (see Figure 2), click **Continue Anyway** to successfully complete the installation of the AD7797 evaluation board.

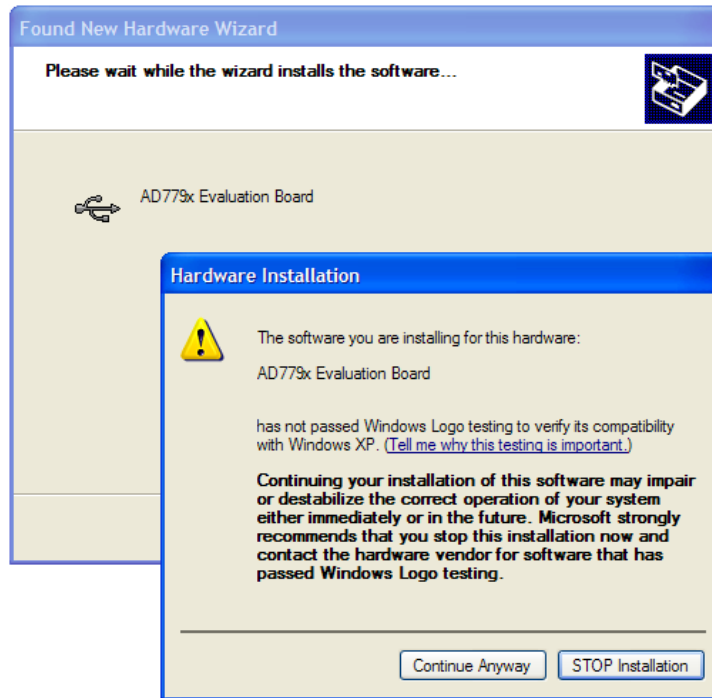

Figure 2. Hardware Installation Window

EVALUATION BOARD SOFTWARE

SOFTWARE DESCRIPTION

The AD7797 evaluation board is shipped with a CD-ROM containing software that can be installed onto a standard PC to control the AD7797. The software uses the USB of the PC to communicate with the AD7797, via the cable that accompanies the board.

The software allows you to configure the AD7797 and to read conversion data from the AD7797.

Data can be read from the AD7797 and displayed or stored for later analysis. For further information, see the AD7797 data sheet available at www.analog.com.

INSTALLING THE SOFTWARE

To install the software,

1. Start Windows® and insert the CD-ROM.
2. The installation software should launch automatically. If it does not, use Windows Explorer to locate the file **setup.exe** on the CD-ROM. Double-click this file to start the installation procedure.
3. At the prompt, select a destination directory, which is **C:\Program Files\Analog Devices\AD7797** by default. Once the directory is selected, the installation procedure copies the files into the relevant directories on the hard drive. The installation program creates a program group called **Analog Devices** with the subgroup **AD7797** in the **Start** menu of the taskbar.
4. Once the installation procedure is complete, double-click the **AD7797** icon to start the program.

USING THE SOFTWARE

Figure 3 shows the main window that is displayed when the program starts. The Main Window Options section briefly describes the various menu and button options on the main window. The Registers and Other Registers sections describe the most commonly used evaluation software windows.

The data that has been read can be exported to other packages, such as MathCAD™ or Microsoft® Excel, for further analysis.

On power-up, the AD7797 evaluation board software configures the device to have an update rate of 16.7 Hz and the **AIN1(-) - AIN1(-)** channel is selected.

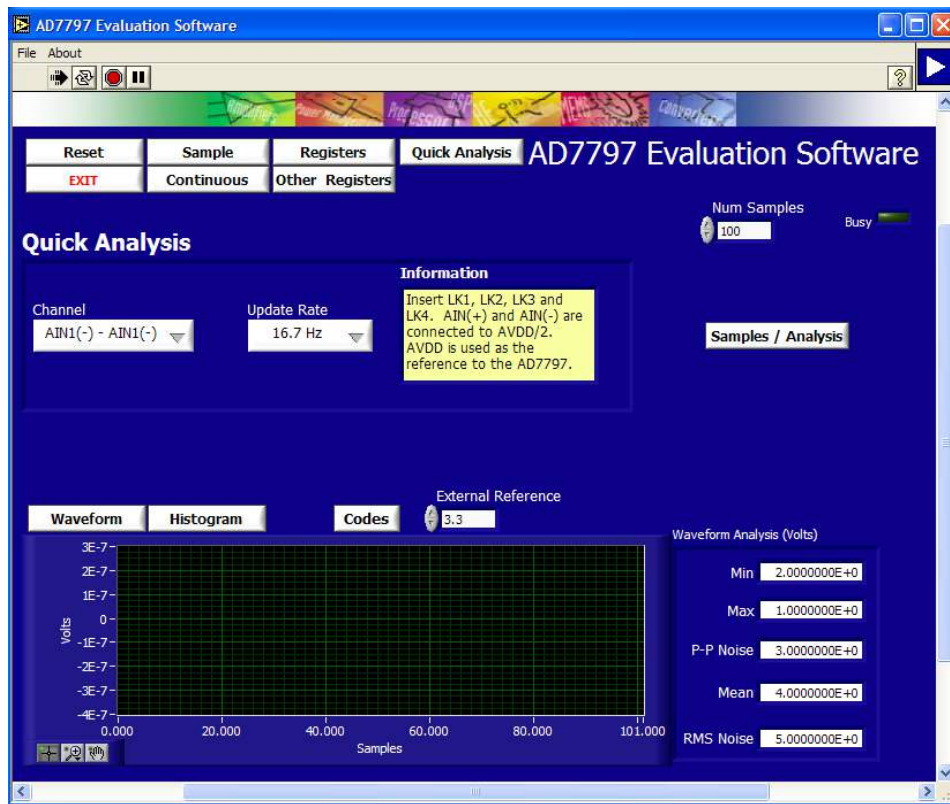

Figure 3. AD7797 Evaluation Software Main Window

MAIN WINDOW OPTIONS

Menu Bar

File. Allows you to read previously stored data for display or analysis, writes the current set of data to a file for later use, and exits the program.

About. Provides information on the revision of software being used.

Buttons

Reset. Allows you to reset the [AD7797](#) and set the registers to the power-up conditions as specified by the software (channel = AIN(–) – AIN(–), update rate = 16.7 Hz).

Exit. Allows you to exit the software. It serves the same purpose as the **Quit** option in the **File** drop-down menu.

Sample. Allows you to read a number of samples from the AD7797. Noise analysis is then performed on the samples. These samples can be stored for further analysis.

The sample size is entered in the **Num Samples** spin box.

Continuous. Allows you to read a number of samples continuously. The software gathers a number of samples as specified by **Num Samples**, performs noise analysis on the samples, and then gathers the next group of samples.

Registers. Allows you to access the configuration register and mode register.

Other Registers. Allows you to access the ID register, status register, offset register, and full-scale register.

Quick Analysis. Displays the **Quick Analysis** window. The **Quick Analysis** window provides access to a subset of the AD7797 control bits: channel and update rate. For access to all control bits, click **Registers** or **Other Registers**.

Samples/Analysis. Serves the same purpose as the **Sample** button.

Waveform. The gathered conversions are displayed in graph form.

Histogram. The gathered samples are used to generate a histogram.

Codes. The gathered samples can be displayed in code or in voltage format. When the **Codes** button is clicked, the values are displayed as code and the **Codes** button changes to **Volts**. To display the information in volts, click **Volts**.

External Reference. The value of the external reference applied to the AD7797 should be entered in the **External Reference** box. The default value is 3.3 V.

REGISTERS

To access the configuration register and the mode register, click **Registers** (see Figure 4). This window allows you to change the update rate, the polarity, and the clock source, among other

options. Consult the [AD7797](#) data sheet for further details on the bit functions.

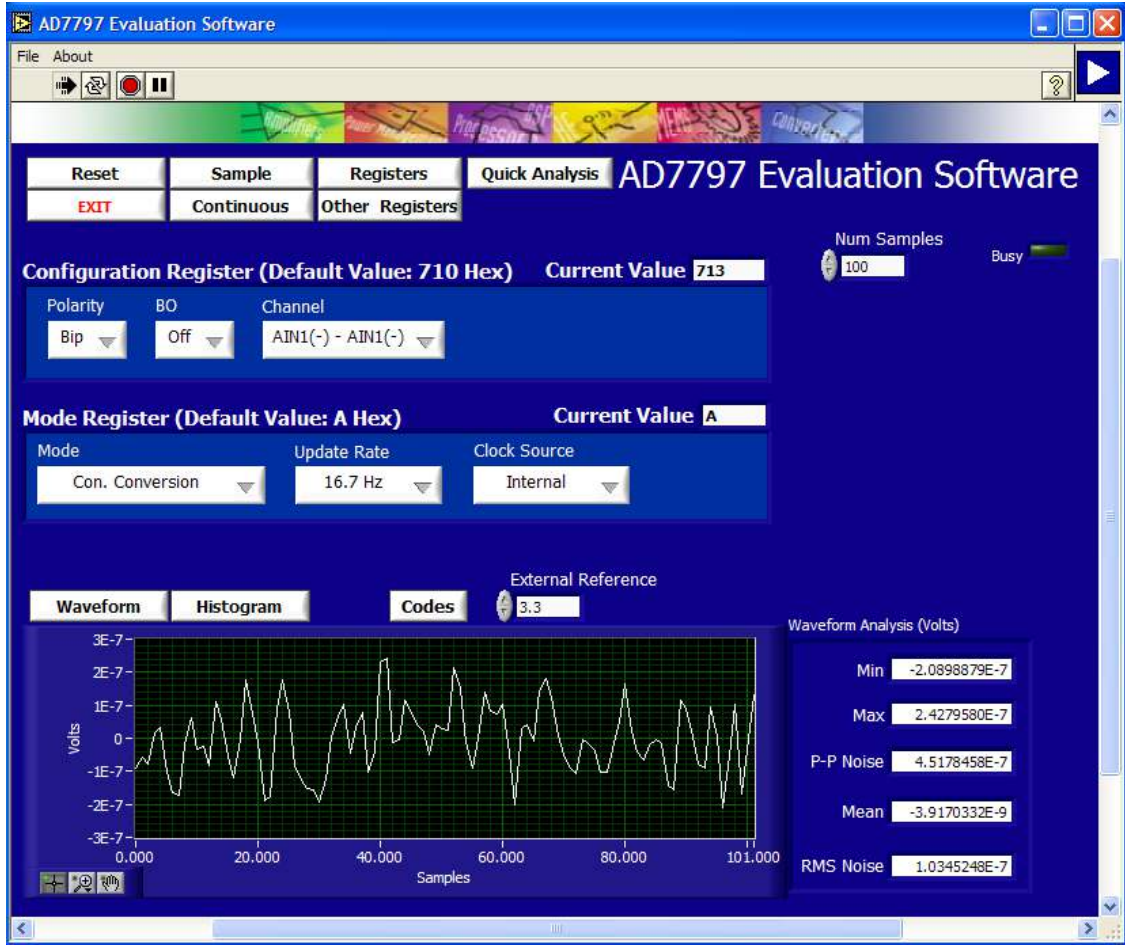

Figure 4. AD7797 Evaluation Software Registers Window

EVAL-AD7797

OTHER REGISTERS

To access additional registers, click **Other Registers** (see Figure 5). This window displays the contents of the offset calibration register, the ID register, the full-scale calibration register, and the status register. To write to the offset calibration and full-

scale calibration registers, you must place the **AD7797** in power-down or idle mode using the **Mode** box in the **Registers** window (see Figure 4).

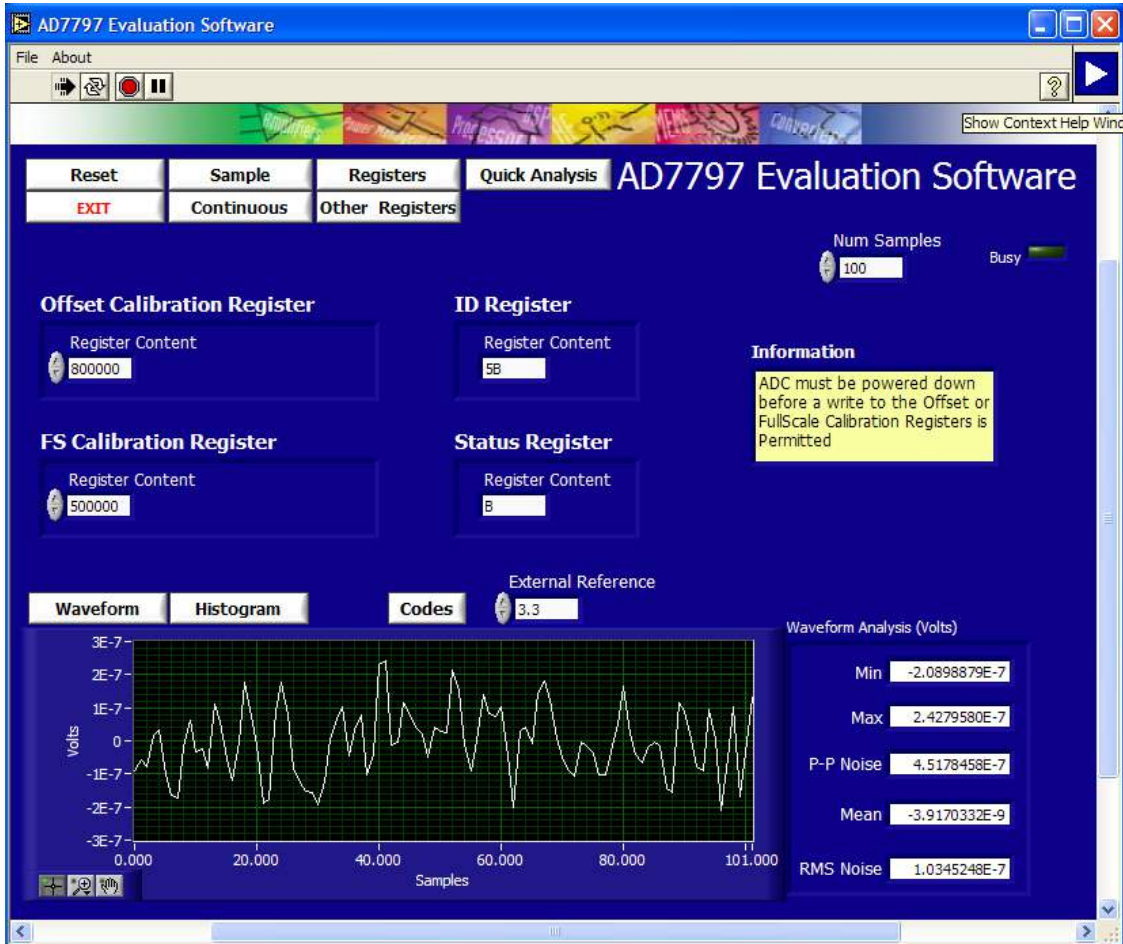
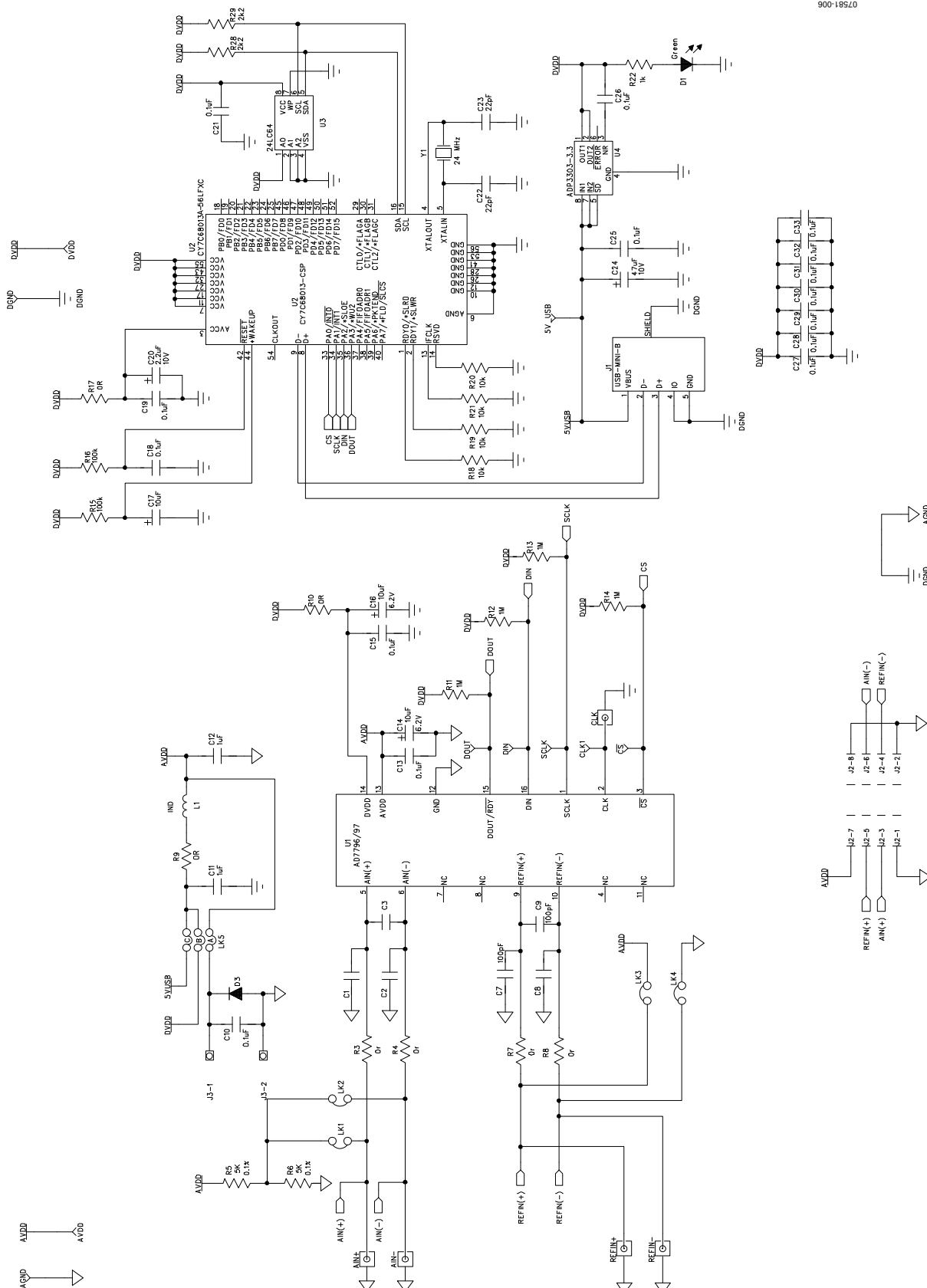

Figure 5. AD7797 Evaluation Software Other Registers Window

EVALUATION BOARD SCHEMATIC AND ARTWORK



900-181-006

Figure 6. AD7797 Evaluation Board Schematic
Rev. 0 | Page 9 of 12

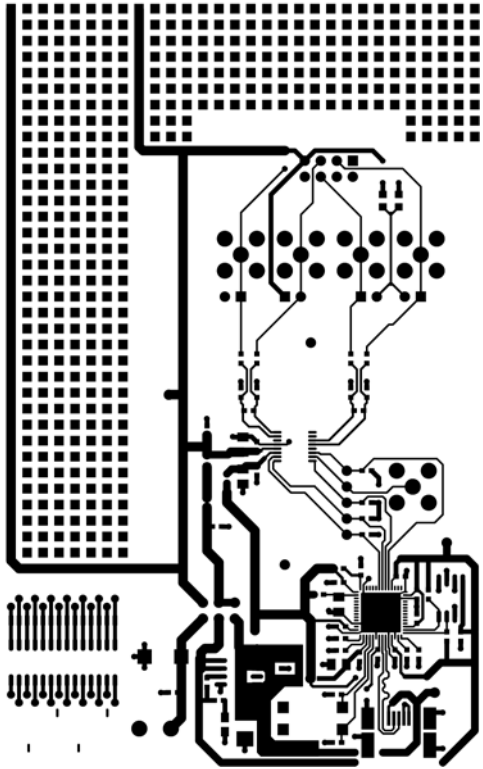

Figure 7. AD7797 Evaluation Board Component Side Artwork

07581-007

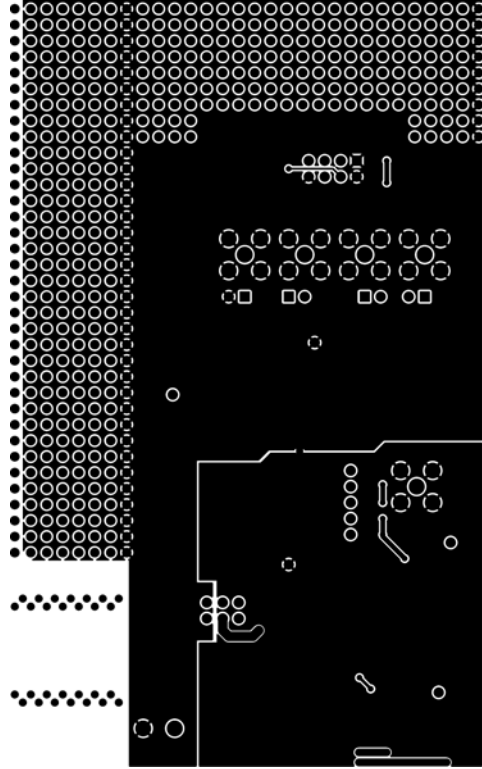

Figure 8. AD7797 Evaluation Board Solder Side Artwork

07581-008

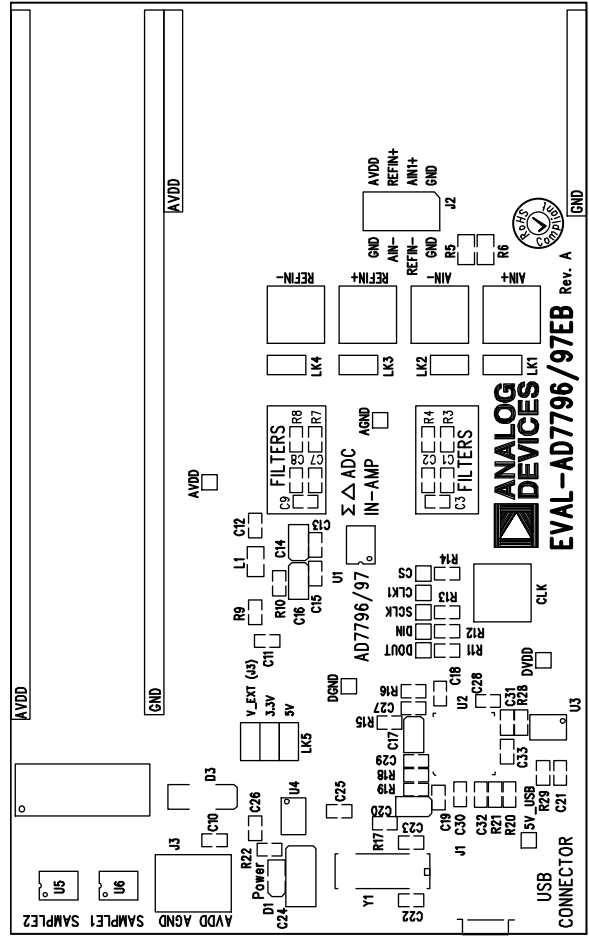

Figure 9. AD7797 Evaluation Board Component Layout Diagram

EVAL-AD7797

ORDERING INFORMATION

BILL OF MATERIALS

Table 4.

Qty	Reference Designator	Description	Manufacturer/Part No.
	Integrated Circuits		
3	U1, U5, U6	AD7797BRUZ	Analog Devices
1	U2	USB controller	Cypress Semiconductor Corporation, CY7C68013A-56LFXC
1	U3	24LC64	Microchip Technology, Inc., 24LC64-I/SN
1	U4	ADP3303ARZ-3.3	Analog Devices
1	Y1	24 MHz crystal	AEL Crystals, X24M000000S244
1	D1	Green LED	Kingbright, Elec. Co., Ltd, P-2012SGC
1	L1	Ferrite bead	Tyco Electronics, BMB2A0300AN1
1	D3	Diode	Micro Commercial Components Corp., DL4001-TP
	Capacitors		
4	C1 to C3, C8	Capacitors	Not inserted
2	C7, C9	100 pF ceramic	AVX Corporation, 06035A101JAT2A
15	C10, C13, C15, C18, C19, C21, C25 to C33	0.1 μ F \pm 10% ceramic	AVX Corporation, CM105X7R104K16AT
3	C14, C16, C17	10 μ F tantalum	AVX Corporation, TAJA106M016R
2	C11, C12	1 μ F ceramic	Yageo Corporation, 2238 246 19863
1	C20	2.2 μ F tantalum	EPCOS AG, B45196E2225K109
2	C22, C23	22 pF ceramic	Yageo Corporation, 2238 867 15229
1	C24	47 μ F tantalum	AVX Corporation, TAJC476K016R
	Resistors		
7	R3, R4, R7 to R10, R17	0 Ω resistor	Phycomp, 232270296001
2	R5, R6	5 k Ω resistor	Tyco Electronics, RN73C2A4K99BTG
4	R11 to R14	1 M Ω resistor	Multicomp, MC 0.063W 0603 1% 1M
2	R15, R16	100 k Ω resistor	Multicomp, MC 0.063W 0603 1% 100K
4	R18 to R21	10 k Ω resistor	Multicomp, MC 0.063W 0603 1% 10K
1	R22	1 k Ω resistor	Multicomp, MC 0.063W 0603 1% 1K
2	R28, R29	2.2 k Ω resistor	Multicomp, MC 0.063W 0603 1% 2K2
	Links		
4	LK1 to LK4 (2 \times 1 way)	Pin headers	Harwin Plc, M20-9990246
1	LK5 (3 \times 2 way)	Pin headers	Harwin Plc, M20-9980346
5	At LK1 to LK5	Shorting plugs	Harwin Plc, M7566-05
	Connectors		
5	AIN+, AIN-, REFIN+, REFIN-, CLK	SMB connector	Not inserted
1	J1	USB Mini-B connector	Molex, 565790576
1	J2	8-pin (2 \times 4) header	Harwin Plc, M20-9980846
1	J3	2-way terminal block	Camden Electronics Ltd., CTB5000/2

ORDERING GUIDE

Model	Description
EVAL-AD7797EBZ ¹	Evaluation Board

¹ Z = RoHS Compliant Part.

ESD CAUTION



ESD (electrostatic discharge) sensitive device. Charged devices and circuit boards can discharge without detection. Although this product features patented or proprietary protection circuitry, damage may occur on devices subjected to high energy ESD. Therefore, proper ESD precautions should be taken to avoid performance degradation or loss of functionality.