

# EVK-C20

## CDMA2000 1xRTT cellular evaluation kit

### User Guide

#### Abstract

This guide explains how to set up the EVK-C20 Evaluation Kit to begin evaluating u-blox CDMA2000 1xRTT cellular modules.



Document Information	
<b>Title</b>	<b>EVK-C20</b>
<b>Subtitle</b>	CDMA2000 1xRTT cellular evaluation kit
<b>Document type</b>	User Guide
<b>Document number</b>	UBX-14040024
<b>Revision, date</b>	R02 15-Oct-2014
<b>Document status</b>	Production Information

Document status explanation	
Objective Specification	Document contains target values. Revised and supplementary data will be published later.
Advance Information	Document contains data based on early testing. Revised and supplementary data will be published later.
Early Production Information	Document contains data from product verification. Revised and supplementary data may be published later.
Production Information	Document contains the final product specification.

#### This document applies to the following products:

Product name	Type number	Firmware version	PCN / IN
EVK-C20	EVK-C20-04S-00	N/A	N/A
	EVK-C20-24S-00	N/A	N/A

u-blox reserves all rights to this document and the information contained herein. Products, names, logos and designs described herein may in whole or in part be subject to intellectual property rights. Reproduction, use, modification or disclosure to third parties of this document or any part thereof without the express permission of u-blox is strictly prohibited.

The information contained herein is provided "as is" and u-blox assumes no liability for the use of the information. No warranty, either express or implied, is given, including but not limited, with respect to the accuracy, correctness, reliability and fitness for a particular purpose of the information. This document may be revised by u-blox at any time. For most recent documents, visit [www.u-blox.com](http://www.u-blox.com).

Copyright © 2014, u-blox AG

u-blox® is a registered trademark of u-blox Holding AG in the EU and other countries. ARM® is the registered trademark of ARM Limited in the EU and other countries.

# Preface

## Using this guide

This guide assumes the user has basic computer skills and is familiar with the Windows Graphical User Interface (GUI) and cellular modem environments.

The following symbols are used to highlight important information in the document:



An index finger points out key information pertaining to device operation and performance.



**A warning symbol indicates actions that could negatively impact or damage the device.**

## Warnings and certifications



EVK-C20 is an Electrostatic Sensitive Device (ESD).



**CAUTION! Risk of short circuit of the battery when touching it with conducting parts. In the unlikely event of a failure in the internal protection circuitry, there is a risk of an explosion when charging fully or partially discharged batteries. Replace the battery if it no longer has sufficient charge for unit operation. Control the battery before using it if the device has not been operated for an extended period of time.**



Products marked with this lead-free symbol on the product label comply with the "Directive 2002/95/EC of the European Parliament and the Council on the Restriction of Use of certain Hazardous Substances in Electrical and Electronic Equipment" (RoHS).

EVK-C20 evaluation kits are RoHS compliant and green (no halogens).

## Technical Support

### Worldwide Web

Our website ([www.u-blox.com](http://www.u-blox.com)) is a rich pool of information. Product information, technical documents and helpful FAQ can be accessed 24h a day.

### By E-mail

If you have technical problems or cannot find the required information in the provided documents, contact the closest Technical Support office. To ensure that we process your request as soon as possible, use our service pool email addresses rather than personal staff email addresses. Contact details are at the end of the document.

### Helpful Information when Contacting Technical Support

When contacting Technical Support please have the following information ready:

- EVK type (e.g. EVK-C20-0-000) and firmware version
- Module configuration
- Clear description of your question or the problem
- A short description of the application
- Your complete contact details

# Contents

<b>Preface .....</b>	<b>3</b>
Using this guide.....	3
Warnings and certifications .....	3
<b>Contents.....</b>	<b>4</b>
<b>1 Starting up.....</b>	<b>5</b>
1.1 EVK-C20 Block diagram.....	6
1.2 Switches.....	6
1.3 LEDs .....	7
1.4 Connectors.....	7
1.5 EVK-C20 Pinout.....	8
1.6 Software installation.....	9
1.7 Board Setup.....	11
1.8 Settings .....	12
<b>Appendix .....</b>	<b>14</b>
<b>A Setting up AT terminal applications for communication with EVK-C20.....</b>	<b>14</b>
A.1 How to set up Hyper Terminal for AT commands.....	14
<b>Related documents.....</b>	<b>15</b>
<b>Revision history.....</b>	<b>15</b>
<b>Contact.....</b>	<b>16</b>

# 1 Starting up

EVK-C20 is a powerful and easy to use tool that makes evaluating u-blox CDMA2000 1xRTT modules simple. This section describes the main connections and settings required to get started.



Refer to LISA-C200 Data Sheet [2] and LISA-C200 and FW75-C200 System Integration Manual [3] for the features supported by LISA-C200 modules.

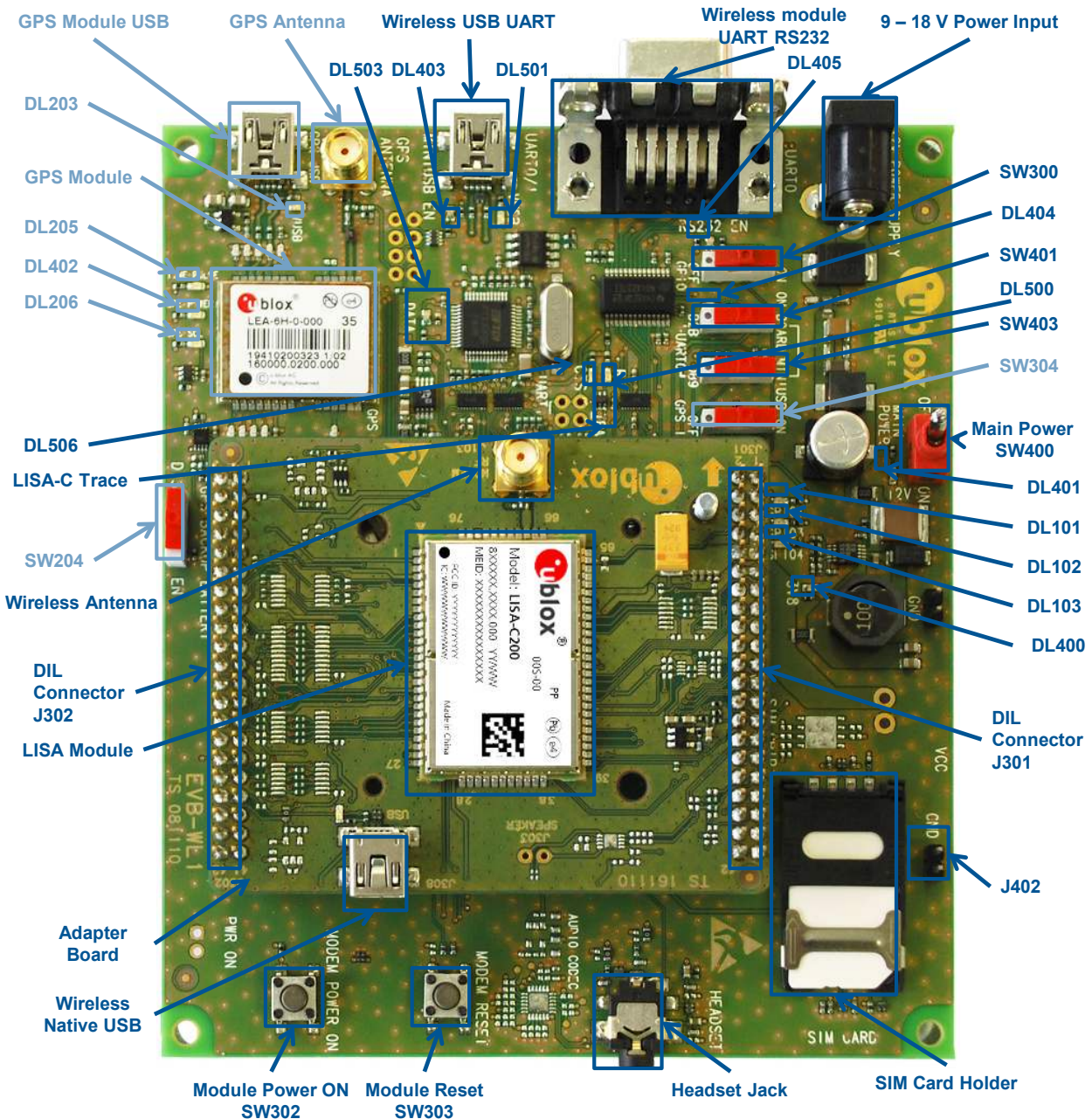

Figure 1: EVK-C20 evaluation kit overview

## 1.1 EVK-C20 Block diagram

Figure 2 shows the main interfaces and internal connections of the EVK-C20:

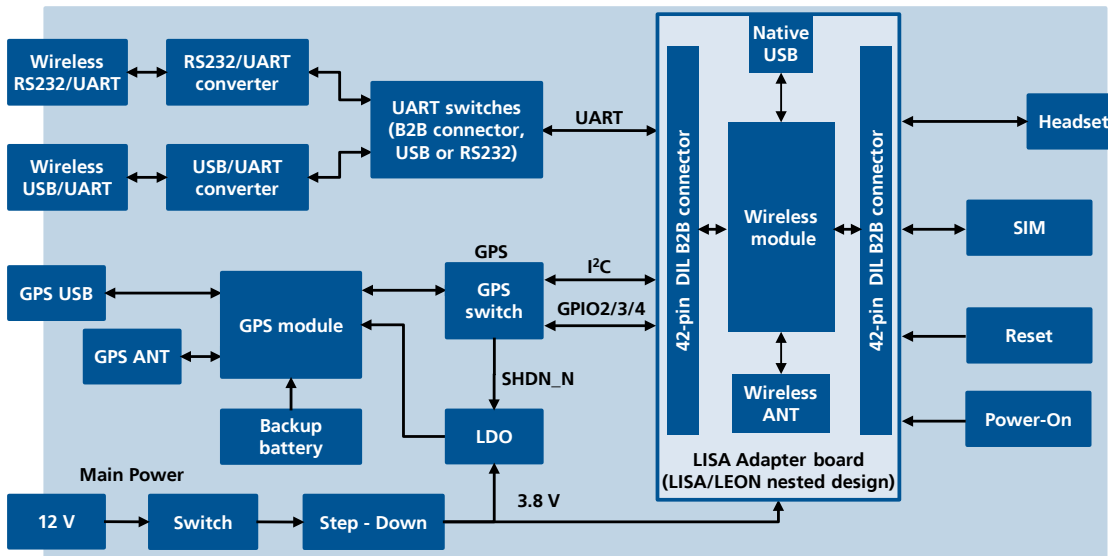

Figure 2: EVK-C20 block diagram

The EVK-C20 is formed by two boards:

- the lower one containing power supply, u-blox GPS module and peripherals
- the upper one, called Adapter Board, where the LISA-C200 cellular module is soldered

The two boards are connected by means of Dual-In-Line male Board-to-Board connectors provided on the bottom of the Adapter Board and the relative female connectors provided on the top of the lower board: in this way the module interfaces are connected to the peripherals available on the lower board.

















Cellular module interfaces are available for test purposes (e.g. for the connection to an external application processor) on the Dual-In-Line male Board-to-Board connectors provided on the top layer of the Adapter Board (J301, J302). These are pin-to-pin compatible to the connectors on the bottom layer of the Adapter Board.

## 1.2 Switches

Function	Description	Name
GPS V_BCKP	Enable battery voltage on V_BCKP pin of GPS	SW204
GPIO interface	Detaches the cellular module GPIOs from the peripherals (GPIO1, SIM_DET and HS_DET)	SW300
Module ON	Push button to switch-on the cellular module	SW302
Module Reset	Push button to reset the cellular module	SW303
GPS Interface	Enable / disables the interface between GPS and cellular module (DDC and GPIO2, GPIO3, GPIO4)	SW304
Power Switch	Power on / off of the whole evaluation kit	SW400
UART on B2B connector	Detach UART interface from USB/UART and RS232/UART on-board connectors: UART interface signals available only on the DIL board-to-board connector on the adapter board	SW401
UART on USB or RS232	Select UART routing on USB/UART on-board connector or on RS232 / UART on-board connector	SW403

Table 1: EVK-C20 switches and buttons description

## 1.3 LEDs

Function	Description	LED #	Color
GPIO1	GPIO1 high	DL101	
GPIO3	GPIO3 high	DL102	
GPIO4	GPIO4 high	DL103	
GPS USB supply	USB cable plugged in GPS module USB connector	DL203	
GPS Timepulse	Pulses at 1 Hz when valid GPS fix	DL205	
SCL activity	Module connected to GPS module by means of the DDC bus	DL206	
VCC	Module supplied. SW400 must be switched ON	DL400	
Main Power	Power supply plugged in J400	DL401	
GPS power supply	GPS power supply is turned ON	DL402	
Bicolor USB/UART	Green light is activated when UART is routed to USB/UART connector Red light blinks at TX or RX data on USB/UART connector	DL403	
UART on adapter board	Serial communication available on adapter board through DIL connector	DL404	
Bicolor RS232/UART	Green light is activated when UART is routed to RS232/UART connector Red light blinks at TX or RX data on RS232/UART connector	DL405	
RI indicator	RI line turns ON (active low)	DL500	
Cellular USB/UART supply	USB cable plugged in cellular module USB/UART connector	DL501	
Bicolor LISA-C Trace LED	LEON Trace TX or RX data	DL503	
CTS indicator	CTS line turns ON (active low)	DL506	

**Table 2: EVK-C20 LEDs description**

## 1.4 Connectors

Function	Description	Name
9 - 18 V Power Input	+12 V AC/DC power adapter input for the whole evaluation kit supply	J400
Cellular module RS232/UART	DB9 connector for cellular module UART interface converted as RS232 interface	J500
Cellular module USB/UART	Mini USB connector for cellular module UART interface converted as USB interface	J501
Cellular native USB	Mini USB connector for cellular module native USB interface (on the Adapter Board)	J202
Cellular antenna	SMA connector for the cellular module antenna (on the Adapter Board)	J100
SIM card	SIM card holder	J300
Headset	Headset connector	J303
DIL B2B headers	Dual-In-Line Board-to-Board connectors for cellular module interfaces (on the Adapter Board)	J200, J201
GPS module USB	Mini USB connector for the GPS module USB interface	J207
GPS antenna	SMA connector for the GPS antenna	J208
GND	Ground terminals for probe reference	J402, J403

**Table 3: EVK-C20 connectors description**



## 1.5 EVK-C20 Pinout

DIL Name/Pin Number	LISA Signal Name	LISA Pin N°	LISA Pin N°	LISA Signal Name	DIL Name/Pin Number
J302 Pins 7-8-9-10	GND	1	65	GND	J302 Pins 7-8-9-10
J302 Pin 3	RSVD	2	64	GND	J302 Pins 7-8-9-10
J302 Pins 7-8-9-10	GND	3	63	VCC	J301 Pin 10
J302 Pin 36	V_INT	4	62	VCC	J301 Pin 9
J302 Pin 22	RSVD	5	51	VCC	J301 Pin 7
J302 Pins 7-8-9-10	GND	6	60	GND	J302 Pins 7-8-9-10
J302 Pins 7-8-9-10	GND	7	59	RSVD	J302 Pin 37
J302 Pins 7-8-9-10	GND	8	58	RSVD	J302 Pin 39
J302 Pin 18	RSVD	9	57	RSVD	J301 Pin 17
J302 Pin 17	RI	10	56	RSVD	J301 Pin 18
J302 Pin 11	RSVD	11	55	RSVD	J301 Pin 19
J302 Pin 12	RSVD	12	54	SPK_N	J301 Pin 34
J302 Pin 13	RTS	13	53	SPK_P	J301 Pin 33
J302 Pin 14	CTS	14	52	RSVD	J302 Pin 24
J302 Pin 15	TXD	15	51	GPIO5	J302 Pin 23
J302 Pin 16	RXD	16	50	VSIM	J301 Pin 13
J302 Pins 7-8-9-10	GND	17	49	SIM_RST	J301 Pin 16
Not present	VUSB_DET	18	48	SIM_IO	J301 Pin 14
J302 Pin 29	PWR_ON	19	47	SIM_CLK	J301 Pin 15
J302 Pin 33	GPIO1	20	46	RSVD	J301 Pin 21
J302 Pin 31	GPIO2	21	45	RSVD	J301 Pin 20
J301 Pin 26	RESET_N	22	44	PCM_DI	J301 Pin 23
J302 Pin 32	GPIO3	23	43	PCM_CLK	J301 Pin 22
J302 Pin 25	GPIO4	24	42	PCM_DO	J301 Pin 24
J302 Pins 7-8-9-10	GND	25	41	PCM_SYNC	J301 Pin 25
Not present	USB_D-	26	40	MIC_P	J301 Pin 28
Not present	USB_D+	27	39	MIC_N	Not present

**Table 4: Cellular module interfaces availability on the 42-pin Dual-In-Line Board-to-Board connectors on the Adapter Board**



## 1.6 Software installation



Installation of the EVK-C20 software and documentation requires Internet access.

The USB driver can be downloaded from the Web; see *the Quick Start card* [5] for the URL. Save the executable file to any location of the hard drive on the computer. Start the installation by running the executable file on the Windows operating system computer..

### Installing the USB driver on Windows:

1. Connect the EVK-C20 to the computer via USB.
2. Open device manager and you shall see two instances of 'Qualcomm CDMA Technologies MSM' under 'Other devices' for Win7 and one each under 'Ports' and "Modems" for WinXP.

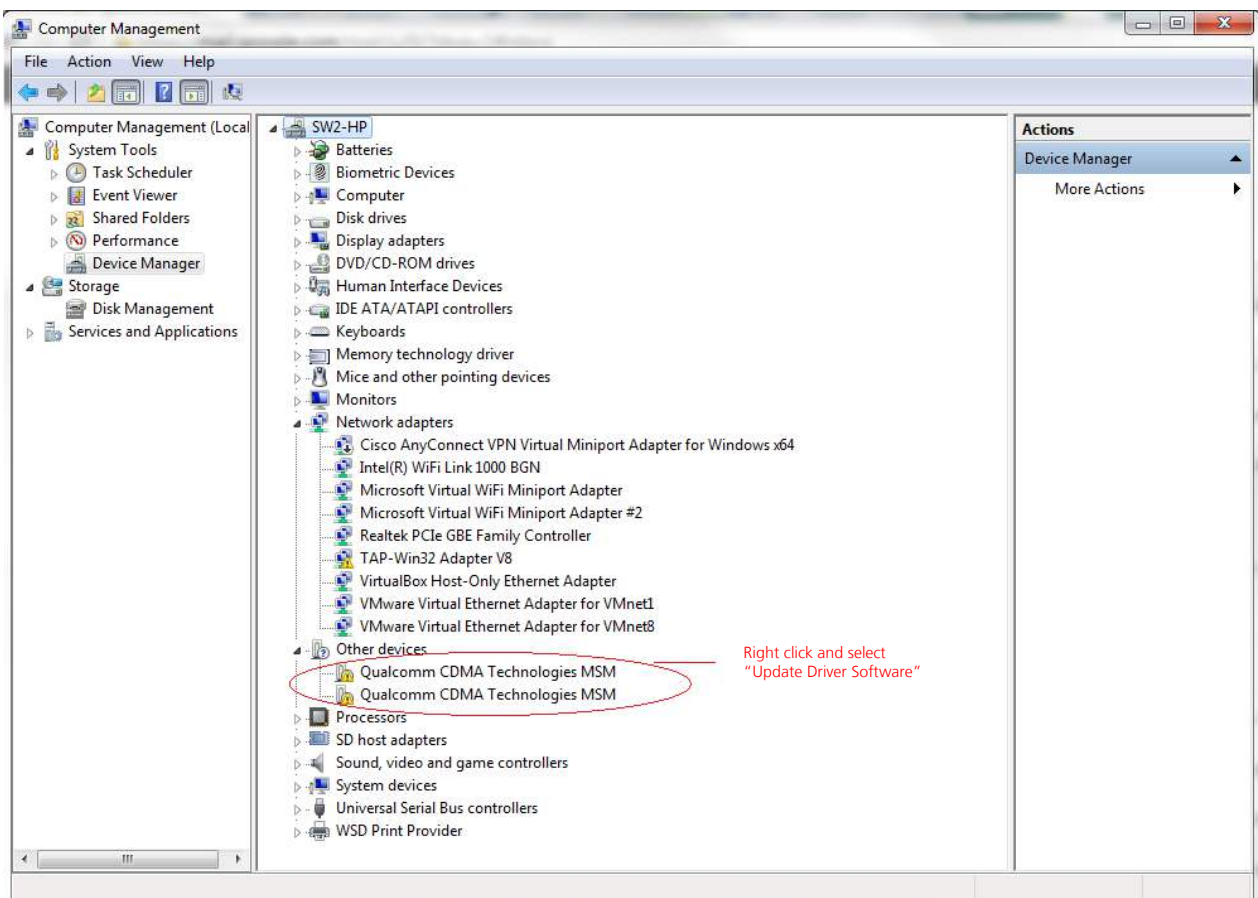

Figure 4: Installing drivers

3. Right click one of them and select 'Update Driver Software' and then select 'Browse my computer for driver software'. The drivers are saved by the Software installation CD, by default, at the following location: For Win7: C:\Program Files (x86)\u-blox\EVK-C20\contents\USBDrivers. Select the appropriate location and click 'Next'. Ignore any warning and the driver would be installed.
4. Repeat step 3 for the other one as well.

The drivers are now installed and you will see one 'Qualcomm HS-USB Diagnostics 9004' port and one 'Qualcomm HS-USB Modem 9004' modem in the Windows Device Manager.



This is a one-time process only. The device will locate the drivers when connected the next time.

### Installing the USB driver on Linux:

No drivers are need on Linux systems. However, the device vendor and product ID must be configured in the Linux configuration file. To set this up follow these steps:

1. On a Linux operating system open a terminal and change directory path to /etc/
2. There should be file named “modules”, use a selected editor such as VI as an example, and open the file for editing
3. Add the following to the file (see Figure 4):
  - lp
  - usbserial vendor=0x05c6 product=0x9004

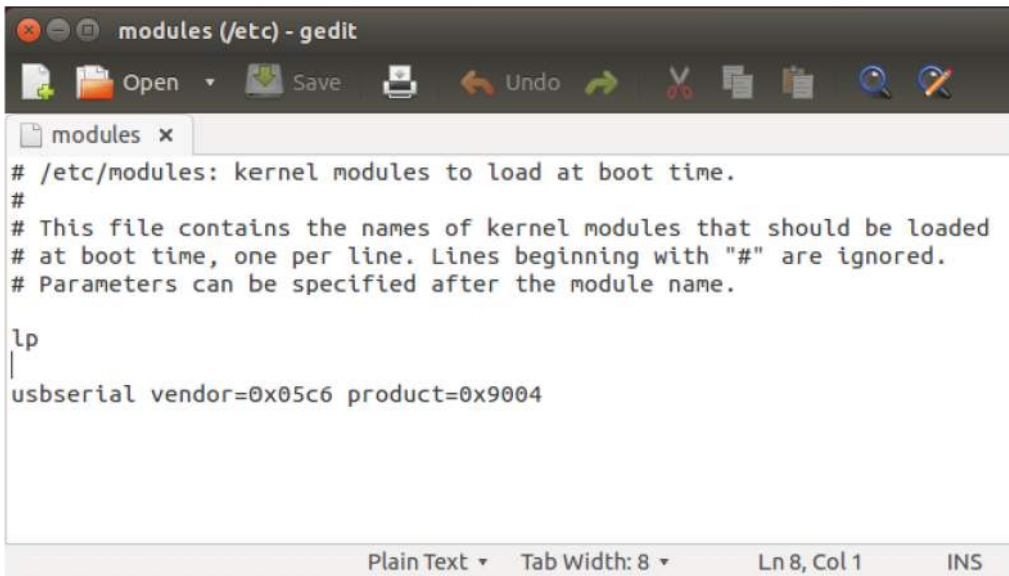

```
# /etc/modules: kernel modules to load at boot time.
#
# This file contains the names of kernel modules that should be loaded
# at boot time, one per line. Lines beginning with "#" are ignored.
# Parameters can be specified after the module name.

lp
usbserial vendor=0x05c6 product=0x9004
```

Figure 3: Adding LISA-C200 Vendor and Product ID to modules file

4. Save and close file
5. Reboot the Linux operating system. This will allow the operating system to read the updated change

## 1.7 Board Setup

- 1 Connect CDMA antenna with SMA connector to **Cellular Antenna** (SMA female connector).
- 2 Connect GPS antenna to **GPS Antenna** (if required).
- 3 Connect power adapter to **9 – 18 V Power Input** connector (J400) (+12 V). DL401 lights blue.
- 4 To supply power to the board turn **Main Power** (SW400) switch to ON position. LED DL400 lights green.
- 5 To switch on the cellular module, press the **Module Power ON** (SW302) button. The cellular module switches on.



If the module is powered off using AT+CPWROFF command, press **Module Power ON** button at the next start up.

- 6 For communication via UART the following connections are allowed: refer to Table 5 for switch position and LED status
  - a. Connect a USB cable to mini USB connector (**Cellular USB/UART J501**), LED DL501 lights blue
  - b. Connect RS232 cable to RS232 connector (**Cellular RS232/UART J500**)

Two COM ports are enabled with Windows. The serial port for AT commands is the one associated with the modem. Open Windows Device Manager and right click on 'Qualcomm HS\_USB Modem 9004' and then select 'Properties' and then 'Modem'. The port# listed there is the serial port for AT commands.

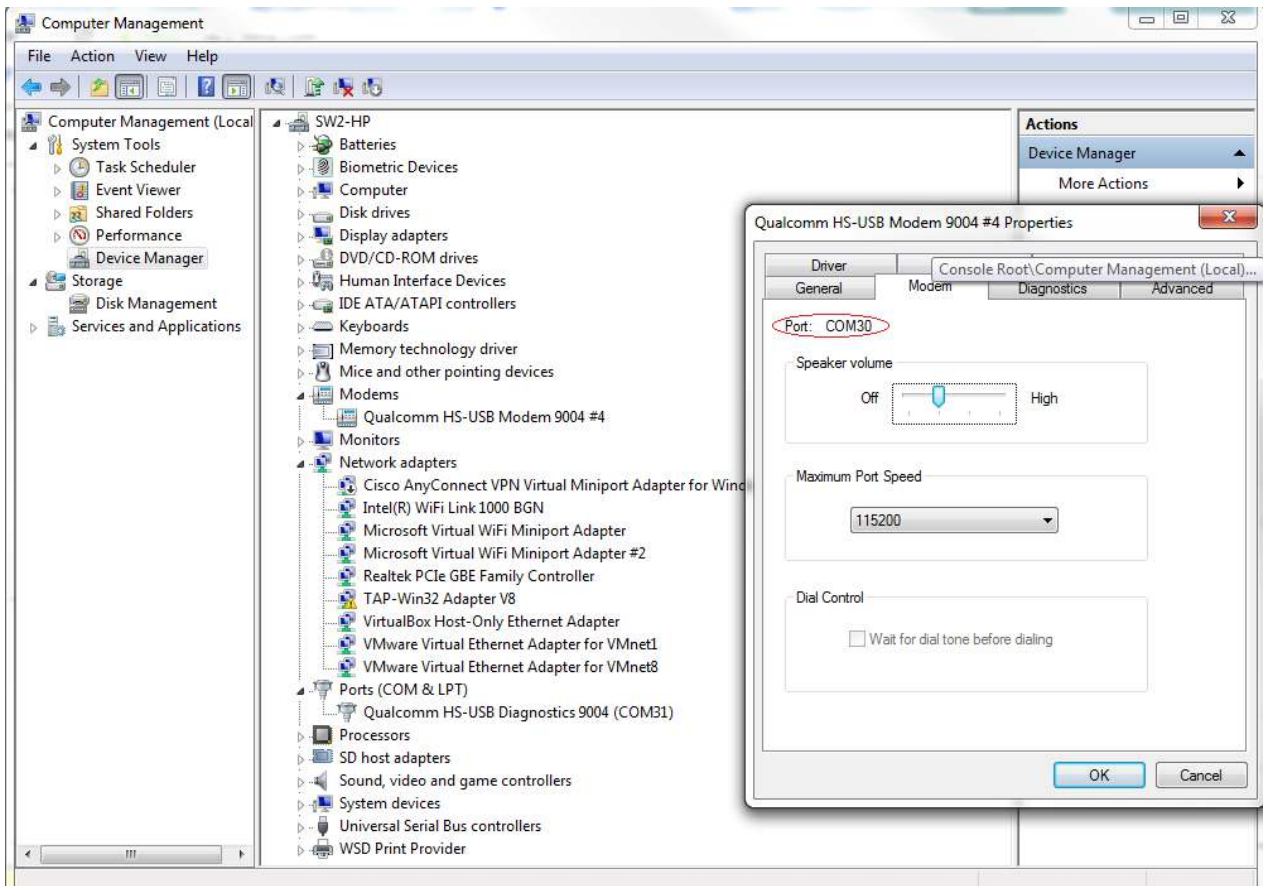

Figure 5: Serial Port for AT commands

Type of connections	SW401	SW403	LED
Access to cellular UART interface by <b>Cellular module USB / UART</b> (mini USB) connector	ON BOARD	MINIUSB	DL403
Access to cellular UART interface by <b>Cellular module RS232 / UART</b> (DB9) connector	ON BOARD	DB9	DL405
Access to cellular UART interface on DIL B2B connector on the adapter board: cellular UART interface detached from USB/UART and RS232/UART connectors	B2B	Do not care	DL404

**Table 5: Serial interface configuration**

- 7 For communication via the native USB connector, connect USB cable to mini USB connector (**Cellular Native USB**) on the "Adapter board". The serial port for AT commands communication is the one associated with the modem.
- 8 Connect headset to **Headset Jack** for audio connection.

## 1.8 Settings

- Connect PC/notebook/terminal to **Cellular USB/UART** or **Native USB** connector. Corresponding LED lights blue

For Windows:

- Check which COM-port is in use (Control panel -> System -> Hardware -> Device Manager)
  - If a USB cable is connected to **Cellular USB/UART** connector, one COM-port is available for AT commands (the one associated with the modem)
  - If a USB cable is connected to **Native USB** connector, one COM-port is available for AT commands (the one associated with the modem)
- Run an AT terminal application (e.g. HyperTerminal) on PC COM-port with the settings shown in Table 6

For Linux:

- Go to the folder /dev/ located off the root directory
- List the filename terminals with the command "ls -la"
- Check for:
  - /ttyUSB0 If a USB cable is connected to **Cellular USB/UART** connector
  - /ttyUSB0 and /ttyUSB1 if a USB cable is connected to **Native USB** connector (see Figure 5 for a sample screenshot)
- If you see it, then the device is recognized by the Linux system. If not, check you USB connection
- With the settings shown in Table 6 , run an AT terminal application (e.g. minicom) on:
  - /ttyUSB0 If a USB cable is connected to **Cellular USB/UART** connector
  - /ttyUSB1 if a USB cable is connected to **Native USB** connector

Parameter	Setting
Data rate	115200 b/s
Data Bits	8
Parity	N
Stop Bits	1
Flow Control	HW

**Table 6: Settings for AT terminal application**

See Appendix A for how to configure the AT-Terminal.

```

ubuntu@ubuntu: /dev
crw-rw---- 1 root dialout 4, 67 Sep 5 11:41 ttyS3
crw-rw---- 1 root dialout 4, 94 Sep 5 11:41 ttyS30
crw-rw---- 1 root dialout 4, 95 Sep 5 11:41 ttyS31
crw-rw---- 1 root dialout 4, 68 Sep 5 11:41 ttyS4
crw-rw---- 1 root dialout 4, 69 Sep 5 11:41 ttyS5
crw-rw---- 1 root dialout 4, 70 Sep 5 11:41 ttyS6
crw-rw---- 1 root dialout 4, 71 Sep 5 11:41 ttyS7
crw-rw---- 1 root dialout 4, 72 Sep 5 11:41 ttyS8
crw-rw---- 1 root dialout 4, 73 Sep 5 11:41 ttyS9
crw-rw---- 1 root dialout 188, 0 Sep 5 18:50 ttyUSB0
crw-rw---- 1 root dialout 188, 1 Sep 5 18:49 ttyUSB1
drwxr-xr-x 3 root root 60 Sep 5 11:41 .udev
crw----- 1 root root 10, 239 Sep 5 11:41 uhid
crw----- 1 root root 10, 223 Sep 5 11:41 uinput
crw-rw-rw- 1 root root 1, 9 Sep 5 11:41 urandom
drwxr-xr-x 2 root root 60 Sep 5 11:40 usb
crw-rw---- 1 root tty 7, 0 Sep 5 11:41 vcs
crw-rw---- 1 root tty 7, 1 Sep 5 11:41 vcs1
crw-rw---- 1 root tty 7, 2 Sep 5 11:41 vcs2
crw-rw---- 1 root tty 7, 3 Sep 5 11:41 vcs3
crw-rw---- 1 root tty 7, 4 Sep 5 11:41 vcs4
crw-rw---- 1 root tty 7, 5 Sep 5 11:41 vcs5
crw-rw---- 1 root tty 7, 6 Sep 5 11:41 vcs6
crw-rw---- 1 root tty 7, 7 Sep 5 11:41 vcs7
crw-rw---- 1 root tty 7, 128 Sep 5 11:41 vcsa
crw-rw---- 1 root tty 7, 129 Sep 5 11:41 vcsa1
crw-rw---- 1 root tty 7, 130 Sep 5 11:41 vcsa2
crw-rw---- 1 root tty 7, 131 Sep 5 11:41 vcsa3
crw-rw---- 1 root tty 7, 132 Sep 5 11:41 vcsa4
crw-rw---- 1 root tty 7, 133 Sep 5 11:41 vcsa5
crw-rw---- 1 root tty 7, 134 Sep 5 11:41 vcsa6
crw-rw---- 1 root tty 7, 135 Sep 5 11:41 vcsa7
crw----- 1 root root 10, 63 Sep 5 11:41 vga_arbiter
crw----- 1 root root 10, 238 Sep 5 11:41 vhost-net
crw-rw-rw- 1 root root 1, 5 Sep 5 11:41 zero
ubuntu@ubuntu: /dev$
    
```

Figure 4: ttyUSB1 is shown when the cellular module is connected to the host via USB connector

## Appendix

# A Setting up AT terminal applications for communication with EVK-C20

### A.1 How to set up Hyper Terminal for AT commands

The example shown is on a Windows XP system.

1. Run Hyper Terminal from Windows: Start > All Programs > Accessories > Communications > HyperTerminal.
2. Set the name for connection (e.g. "*u-blox Cellular Module*"), then press OK.



3. Select the PC serial port (for example COM6, check with the Device Manager which port is being used by EVK-C20), then press OK.



4. Select the settings shown here for EVK-C20 serial port settings; then select Apply/OK.
5. A new window opens and the AT-command terminal is now ready for communication with EVK-C20 (make sure the power is on).

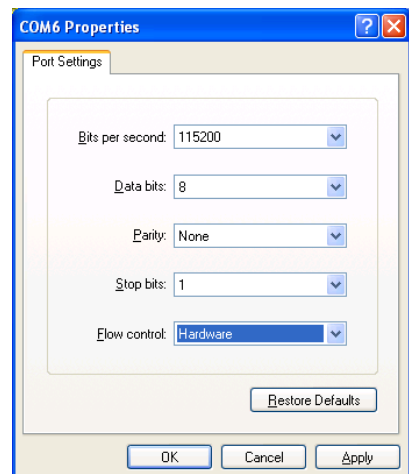

## Related documents

- [1] u-blox LISA-C200 and FW75-C200 AT Commands Manual, Docu No UBX-13000621
- [2] u-blox LISA-C200 Data Sheet, Docu No UBX-13000623
- [3] u-blox LISA-C200 and FW75-C200 System Integration Manual, Docu No UBX-13000620

All these documents are available on our homepage (<http://www.u-blox.com>).



For regular updates to u-blox documentation and to receive product change notifications please register on our homepage.

## Revision history

Revision	Date	Name	Status / Comments
R01	14-Aug-2012	pafe	Initial release (last revision with document number CDMA-EK-12017)
R02	15-Oct-2014	pafe	Instructions for Linux aded



# Contact

For complete contact information visit us at [www.u-blox.com](http://www.u-blox.com)

## u-blox Offices

### North, Central and South America

#### u-blox America, Inc.

Phone: +1 703 483 3180  
E-mail: [info\\_us@u-blox.com](mailto:info_us@u-blox.com)

#### Regional Office West Coast:

Phone: +1 408 573 3640  
E-mail: [info\\_us@u-blox.com](mailto:info_us@u-blox.com)

#### Technical Support:

Phone: +1 703 483 3185  
E-mail: [support\\_us@u-blox.com](mailto:support_us@u-blox.com)

### Headquarters Europe, Middle East, Africa

#### u-blox AG

Phone: +41 44 722 74 44  
E-mail: [info@u-blox.com](mailto:info@u-blox.com)  
Support: [support@u-blox.com](mailto:support@u-blox.com)

### Asia, Australia, Pacific

#### u-blox Singapore Pte. Ltd.

Phone: +65 6734 3811  
E-mail: [info\\_ap@u-blox.com](mailto:info_ap@u-blox.com)  
Support: [support\\_ap@u-blox.com](mailto:support_ap@u-blox.com)

#### Regional Office Australia:

Phone: +61 2 8448 2016  
E-mail: [info\\_au@u-blox.com](mailto:info_au@u-blox.com)  
Support: [support\\_ap@u-blox.com](mailto:support_ap@u-blox.com)

#### Regional Office China (Beijing):

Phone: +86 10 68 133 545  
E-mail: [info\\_cn@u-blox.com](mailto:info_cn@u-blox.com)  
Support: [support\\_cn@u-blox.com](mailto:support_cn@u-blox.com)

#### Regional Office China (Shenzhen):

Phone: +86 755 8627 1083  
E-mail: [info\\_cn@u-blox.com](mailto:info_cn@u-blox.com)  
Support: [support\\_cn@u-blox.com](mailto:support_cn@u-blox.com)

#### Regional Office India:

Phone: +91 959 1302 450  
E-mail: [info\\_in@u-blox.com](mailto:info_in@u-blox.com)  
Support: [support\\_in@u-blox.com](mailto:support_in@u-blox.com)

#### Regional Office Japan:

Phone: +81 3 5775 3850  
E-mail: [info\\_jp@u-blox.com](mailto:info_jp@u-blox.com)  
Support: [support\\_jp@u-blox.com](mailto:support_jp@u-blox.com)

#### Regional Office Korea:

Phone: +82 2 542 0861  
E-mail: [info\\_kr@u-blox.com](mailto:info_kr@u-blox.com)  
Support: [support\\_kr@u-blox.com](mailto:support_kr@u-blox.com)

#### Regional Office Taiwan:

Phone: +886 2 2657 1090  
E-mail: [info\\_tw@u-blox.com](mailto:info_tw@u-blox.com)  
Support: [support\\_tw@u-blox.com](mailto:support_tw@u-blox.com)