

# Advantech

## AQD-D3L4GR16-SG

### Datasheet

Rev. 1.1  
2013-09-24

## Description

AQD-D3L4GR16-SG is a DDR3 Registered DIMM, high-speed, low power memory module that use 9 pcs of 512Mx8bits DDR3L low voltage SDRAM in FBGA package, 1 pcs register in TFBGA package and a 2048 bits serial EEPROM on a 240-pin printed circuit board. AQD-D3L4GR16-SG is a Dual In-Line Memory Module and is intended for mounting into 240-pin edge connector sockets.

Synchronous design allows precise cycle control with the use of system clock. Data I/O transactions are possible on both edges of DQS. Range of operation frequencies, programmable latencies allow the same device to be useful for a variety of high bandwidth, high performance memory system applications.

## Features

- RoHS compliant products.
- JEDEC standard 1.35V(1.28V~1.45V) Power supply
- JEDEC standard 1.5V(1.425V~1.575V) Power supply
- VDDQ=1.35V(1.28V~1.45V) & 1.5V(1.425V~1.575V)
- Clock Freq: 667MHZ for 1333Mb/s/Pin.
- Clock Freq: 800MHZ for 1600Mb/s/Pin.
- Programmable CAS Latency: 6, 7, 8, 9, 10, 11
- Programmable Additive Latency (Posted /CAS):  
0,CL-2 or CL-1 clock
- Programmable /CAS Write Latency (CWL)  
= 8(DDR3-1600)
- 8 bit pre-fetch
- Burst Length: 4, 8
- Bi-directional Differential Data-Strobe
- Internal calibration through ZQ pin
- On Die Termination with ODT pin
- On DIMM thermal Sensor

## Pin Identification

### Pin Identification

Symbol	Function
A0~A15, BA0~BA2	Address Inputs
/RAS	Row Address Strobe
/CAS	Column Address Strobe
/WE	Write Enable
/S0, /S1	Chip Selects
CKE0, CKE1	Clock Enables
ODT0, ODT1	On-die termination control
DQ0~DQ63	Data Input/Output
CB0~CB7	ECC Check bits
DQS0~DQS8 /DQS0~/DQS8	Data Strobe
DM0~DM8	Data Masks
CK0, /CK0	Clocks Input
/RESET	Reset Pin
/EVENT	Temperature Event Pin
/ERROUT	Parity error found on address and control bus
Par-In	Parity bit for address and Control bus
VDD	Core and I/O Power
VSS	Ground
VREFDQ, VREFCA	Input/Output Reference
VTT	Termination Voltage
VDDSPD	SPD Power
SCL	SPD Clock Input
SDA	SPD Data
SA0~SA2	SPD Address

NC	No Connection
----	---------------

**Dimensions (Unit: millimeter)**

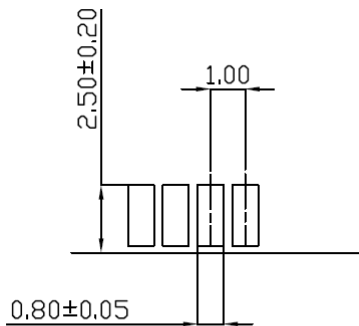
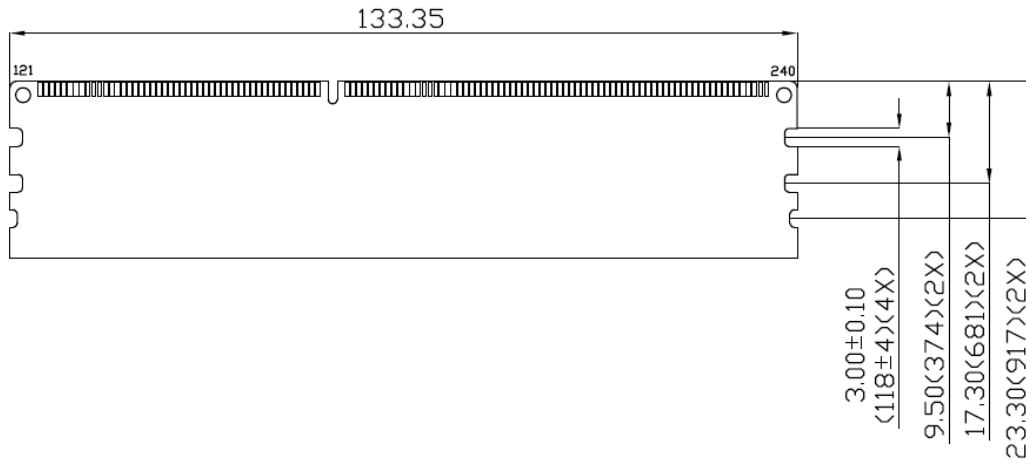
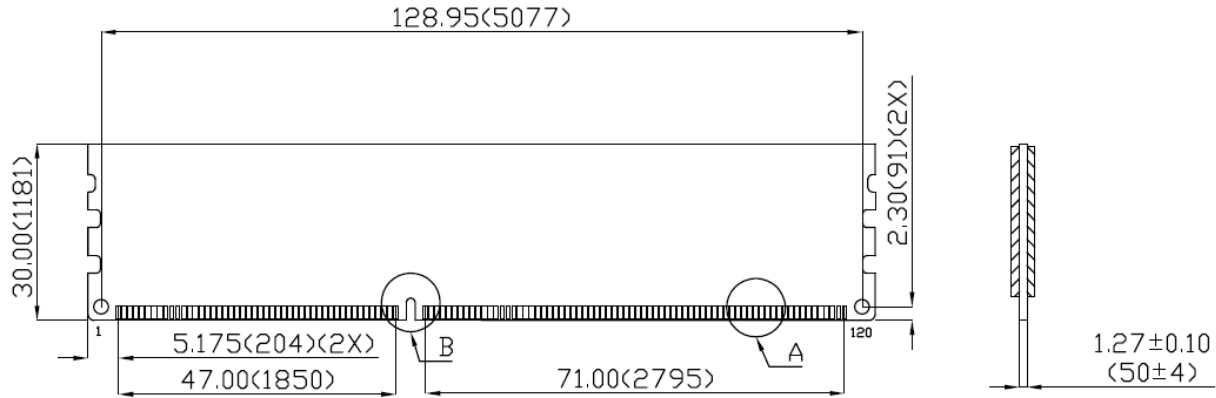

Detail A

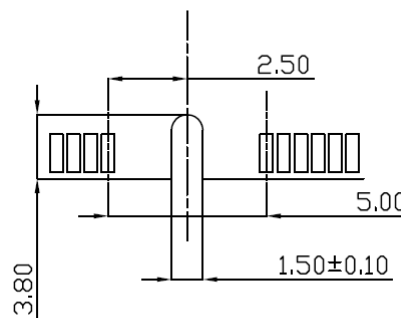

Detail B

**Note:**

1. Tolerances on all dimensions +/-0.15mm unless otherwise specified.

## Pin Assignments

Pin No	Pin Name	Pin No	Pin Name	Pin No	Pin Name	Pin No	Pin Name	Pin No	Pin Name	Pin No	Pin Name
01	VREFDQ	41	VSS	81	DQ32	121	VSS	161	TDQS17	201	DQ37
02	VSS	42	/DQS8	82	DQ33	122	DQ4	162	/TDQS17	202	VSS
03	DQ0	43	DQS8	83	VSS	123	DQ5	163	VSS	203	TDQS13
04	DQ1	44	VSS	84	/DQS4	124	VSS	164	CB6	204	/TDQS13
05	VSS	45	CB2	85	DQS4	125	TDQS9	165	CB7	205	VSS
06	/DQS0	46	CB3	86	VSS	126	/TDQS9	166	VSS	206	DQ38
07	DQS0	47	VSS	87	DQ34	127	VSS	167	NC	207	DQ39
08	VSS	48	VTT	88	DQ35	128	DQ6	168	/RESET	208	VSS
09	DQ2	49	VTT	89	VSS	129	DQ7	169	CKE1,NC	209	DQ44
10	DQ3	50	CKE0	90	DQ40	130	VSS	170	VDD	210	DQ45
11	VSS	51	VDD	91	DQ41	131	DQ12	171	A15	211	VSS
12	DQ8	52	BA2	92	VSS	132	DQ13	172	A14	212	TDQS14
13	DQ9	53	/Err_Out	93	/DQS5	133	VSS	173	VDD	213	/TQS14
14	VSS	54	VDD	94	DQS5	134	TDQS10	174	A12	214	VSS
15	/DQS1	55	A11	95	VSS	135	/TDQS10	175	A9	215	DQ46
16	DQS1	56	A7	96	DQ42	136	VSS	176	VDD	216	DQ47
17	VSS	57	VDD	97	DQ43	137	DQ14	177	A8	217	VSS
18	DQ10	58	A5	98	VSS	138	DQ15	178	A6	218	DQ52
19	DQ11	59	A4	99	DQ48	139	VSS	179	VDD	219	DQ53
20	VSS	60	VDD	100	DQ49	140	DQ20	180	A3	220	VSS
21	DQ16	61	A2	101	VSS	141	DQ21	181	A1	221	TDQS15
22	DQ17	62	VDD	102	/DQS6	142	VSS	182	VDD	222	/TDQS15
23	VSS	63	NC	103	DQS6	143	TDQS11	183	VDD	223	VSS
24	/DQS2	64	NC	104	VSS	144	/TDQS11	184	CK0	224	DQ54
25	DQS2	65	VDD	105	DQ50	145	VSS	185	/CK0	225	DQ55
26	VSS	66	VDD	106	DQ51	146	DQ22	186	VDD	226	VSS
27	DQ18	67	VREFCA	107	VSS	147	DQ23	187	/EVENT	227	DQ60
28	DQ19	68	Par-In	108	DQ56	148	VSS	188	A0	228	DQ61
29	VSS	69	VDD	109	DQ57	149	DQ28	189	VDD	229	VSS
30	DQ24	70	A10/AP	110	VSS	150	DQ29	190	BA1	230	TDQS16
31	DQ25	71	BA0	111	/DQS7	151	VSS	191	VDD	231	/TDQS16
32	VSS	72	VDD	112	DQS7	152	TDQS12	192	/RAS	232	VSS
33	/DQS3	73	/WE	113	VSS	153	/TDQS12	193	/S0	233	DQ62
34	DQS3	74	/CAS	114	DQ58	154	VSS	194	VDD	234	DQ63
35	VSS	75	VDD	115	DQ59	155	DQ30	195	ODT0	235	VSS
36	DQ26	76	/S1	116	VSS	156	DQ31	196	A13	236	VDDSPD
37	DQ27	77	ODT1,NC	117	SA0	157	VSS	197	VDD	237	SA1
38	VSS	78	VDD	118	SCL	158	CB4	198	/S3,NC	238	SDA
39	CB0	79	/S2,NC	119	SA2	159	CB5	199	VSS	239	VSS
40	CB1	80	VSS	120	VTT	160	VSS	200	DQ36	240	VTT

ODT1, CKE1 : Connected to the register on 2 and 4 rank RDIMM ; NC on 1 rank RDIMM

/S2, /S3 : Connected to the register on 4 rank RDIMM ; NC on 1 or 2 rank RDIMM

## Block Diagram 4GB, 512Mx72 Module(1 Rank x8)

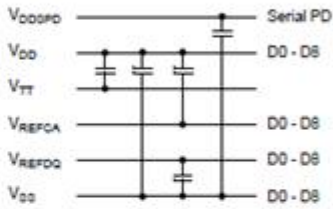
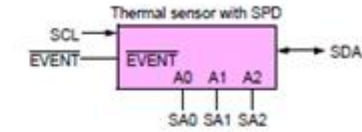
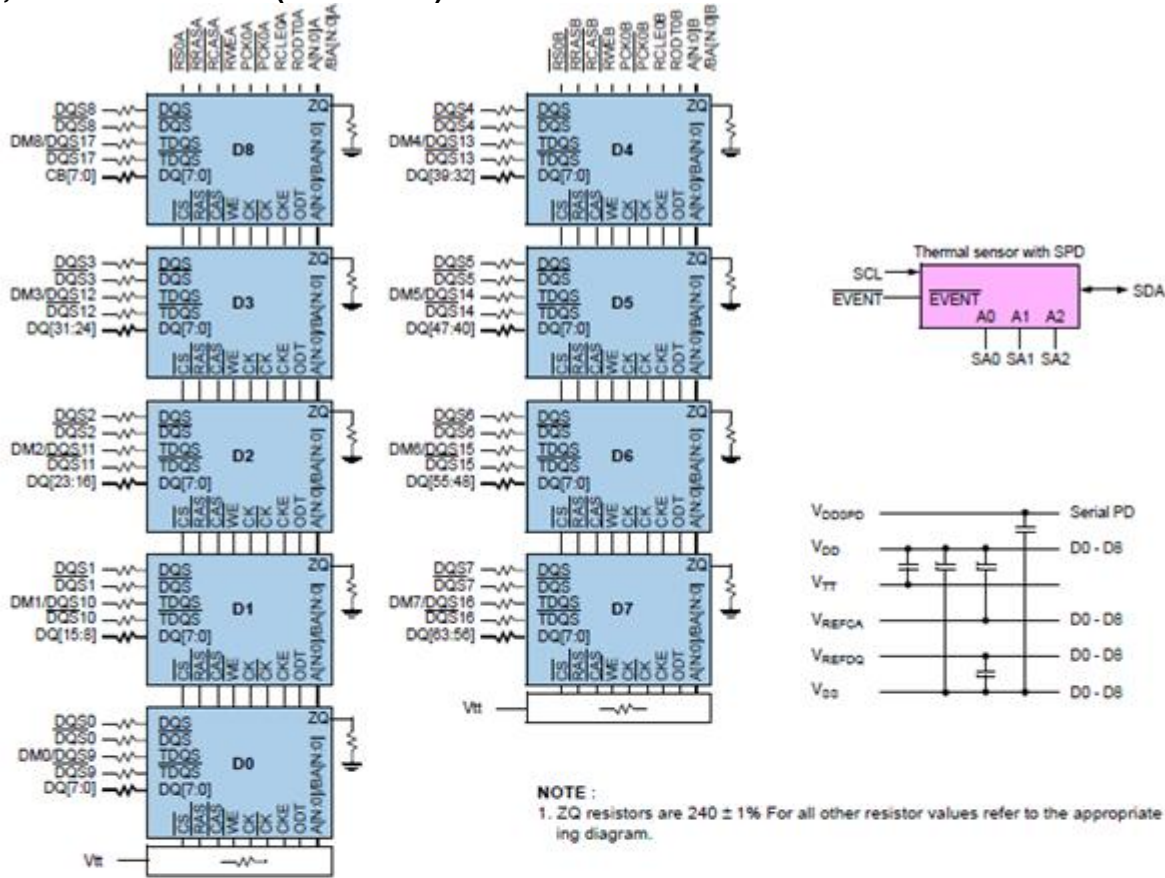

**NOTE :**  
1. ZQ resistors are  $240 \pm 1\%$  For all other resistor values refer to the appropriate wiring diagram.

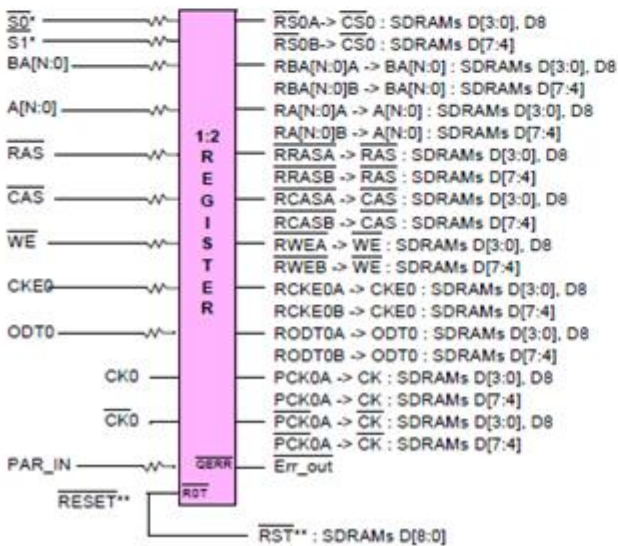

\*S[3:2], CKE1, ODT1, CK1 and CK1 are NC  
(Unused register inputs ODT1 and CKE1 have a 330 ohm resistor to ground)

## Operating Temperature Condition

Parameter	Symbol	Rating	Unit	Note
Operating Temperature	TOPER	0 to 85	°C	1,2

Note: Operating Temperature is the case surface temperature on the center/top side of the DRAM. For the measurement conditions, please refer to JESD51-2 standard.

## Absolute Maximum DC Ratings

Parameter	Symbol	Value	Unit	Note
Voltage on VDD relative to Vss	VDD	-0.4 ~ 1.975	V	1
Voltage on VDDQ pin relative to Vss	VDDQ	-0.4 ~ 1.975	V	1
Voltage on any pin relative to Vss	VIN, VOUT	-0.4 ~ 1.975	V	1
Storage temperature	TSTG	-55~+100	°C	1,2

Note: 1. Stress greater than those listed under “Absolute Maximum Ratings” may cause permanent damage to the device. This is a stress rating only and functional operation of the device at these or any other conditions above those indicated in the operational sections of this specification is not implied. Exposure to absolute maximum rating conditions for extended periods may affect reliability.  
2. Storage Temperature is the case surface temperature on the center/top side of the DRAM. For the measurement conditions, please refer to JESD51-2 standard.

## AC & DC Operating Conditions

### Recommended DC operating conditions

Parameter	Symbol	Voltage	Rating			Unit	Notes
			Min	Typ.	Max		
Supply voltage	VDD	1.35V	1.283	1.35	1.45	V	1, 2
		1.5V	1.425	1.5	1.575		
Supply voltage for Output	VDDQ	1.35V	1.283	1.35	1.45	V	1, 2
		1.5V	1.425	1.5	1.575		
I/O Reference Voltage (DQ)	VREF <sub>DQ</sub> (DC)	1.35V	0.49*VDDQ	0.50*VDDQ	0.51*VDDQ	V	3
I/O Reference Voltage (CMD/ADD)	VREF <sub>CA</sub> (DC)	1.5V	0.49*VDDQ	0.50*VDDQ	0.51*VDDQ	V	3
AC Input Logic High	VIH(AC)	1.35V	VREF+0.160	-	-	V	
		1.5V	VREF+0.175	-	-		
AC Input Logic Low	VIL(AC)	1.35V	-	-	VREF-0.160	V	
		1.5V	-	-	VREF-0.175		
DC Input Logic High	VIH(DC)	1.35V	VREF+0.09	-	VDD	V	
		1.5V	VREF+0.1	-	VDD		
DC Input Logic Low	VIL(DC)	1.35V	VSS	-	VREF-0.09	V	
		1.5V	VSS	-	VREF-0.1		

Note: 1. Under all conditions VDDQ must be less than or equal to VDD.  
2. VDDQ tracks with VDD, AC parameters are measured with VDD and VDDQ tied together.  
3. Peak to peak AC noise on VREF may not allow deviate from VREF(DC) by more than +/-1% VDD.

### IDD Specification parameters Definition

(IDD values are for full operating range of Voltage and Temperature)

#### 4GB, 512Mx72 Module(1 Rank x8)

Parameter	Symbol	DDR3 1600 CL11	Unit
<b>Operating One bank Active-Precharge current;</b> tCK = tCK(IDD), tRC = tRC(IDD), tRAS = tRASmin(IDD); CKE is HIGH, /CS is HIGH between valid commands;Address bus inputs are SWITCHING; Data bus inputs are SWITCHING	IDD0	495	mA
<b>Operating One bank Active-read-Precharge current;</b> IOUT = 0mA; BL = 8, CL = CL(IDD), AL = 0; tCK = tCK(IDD), tRC = tRC (IDD), tRAS = tRASmin(IDD), tRCD = tRCD(IDD); CKE is HIGH, /CS is HIGH between valid commands; Address bus inputs are SWITCHING; Data pattern is same as IDD4W	IDD1	594	mA
<b>Precharge power-down current;</b> All banks idle; tCK = tCK(IDD); CKE is LOW; Other control and address bus inputs are STABLE; Data bus inputs are FLOATING	IDD2P	288	mA
<b>Precharge quiet standby current;</b> All banks idle; tCK = tCK(IDD); CKE is HIGH, /CS is HIGH; Other control and address bus inputs are STABLE; Data bus inputs are FLOATING	IDD2Q	288	mA
<b>Precharge standby current;</b> All banks idle; tCK = tCK(IDD); CKE is HIGH, /CS is HIGH; Other control and address bus inputs are SWITCHING; Data bus inputs are SWITCHING	IDD2N	288	mA
<b>Active power - down current;</b> All banks open; tCK = tCK(IDD); CKE is LOW; Other control and address bus inputs are STABLE; Data bus inputs are FLOATING	IDD3P	342	mA
<b>Active standby current;</b> All banks open; tCK = tCK(IDD), tRAS = tRASmax(IDD), tRP = tRP(IDD); CKE is HIGH, /CS is HIGH between valid commands; Other control and address bus inputs are SWITCHING; Data bus inputs are SWITCHING	IDD3N	342	mA
<b>Operating burst read current;</b> All banks open, Continuous burst reads, IOUT = 0mA; BL = 4, CL = CL(IDD), AL = 0; tCK = tCK(IDD), tRAS = tRASmax(IDD), tRP = tRP(IDD); CKE is HIGH, /CS is HIGH between valid commands; Address bus inputs are SWITCHING; Data pattern is same as IDD4W	IDD4R	1413	mA
<b>Operating burst write current;</b> All banks open, Continuous burst writes; BL = 8, CL = CL(IDD), AL = 0; tCK = tCK(IDD), tRAS = tRASmax(IDD), tRP = tRP(IDD); CKE is HIGH, /CS is HIGH between valid commands; Address bus inputs are SWITCHING; Data bus inputs are SWITCHING IDD4R	IDD4W	1125	mA
<b>Burst refresh current;</b> tCK = tCK(IDD); Refresh command at every tRFC(IDD) interval; CKE is HIGH, /CS is HIGH between valid commands; Other control and address bus inputs are SWITCHING; Data bus inputs are SWITCHING	IDD5	1395	mA
<b>Self refresh current;</b> CK and /CK at 0V; CKE = 0.2V; Other control and address bus inputs are FLOATING; Data bus inputs are FLOATING	IDD6	225	mA
<b>Operating bank interleave read current;</b> All bank interleaving reads, IOUT = 0mA; BL = 8, CL = CL(IDD), AL = tRCD(IDD)-1*tCK(IDD); tCK = tCK(IDD), Trc = tRC(IDD), tRRD = tRRD(IDD), tRCD = 1*tCK(IDD); CKE is HIGH, CS is HIGH between valid commands;Address bus inputs are STABLE during DESELECTs; Data pattern is same as IDD4R;	IDD7	1980	mA

Note: 1.Module IDD was calculated on the specific brand DRAM(3xnm) component IDD and can be differently measured according to DQ loading capacitor.

**Timing Parameters & Specifications**

Speed		DDR3 1600		Unit
Parameter	Symbol	Min	Max	
Average Clock Period	tCK	1.25	<1.5	ns
CK high-level width	tCH	0.47	0.53	tCK
CK low-level width	tCL	0.47	0.53	tCK
DQS, /DQS to DQ skew, per group, per access	tDQSQ	-	100	ps
DQ output hold time from DQS, /DQS	tQH	0.38	-	tCK
DQ low-impedance time from CK, /CK	tLZ(DQ)	-450	225	ps
DQ high-impedance time from CK, /CK	tHZ(DQ)	-	225	ps
Data setup time to DQS, /DQS reference to Vih(ac)Vil(ac) levels	tDS	10	-	ps
Data hold time to DQS, /DQS reference to Vih(ac)Vil(ac) levels	tDH	45	-	ps
DQ and DM input pulse width for each input	tDIPW	360	-	ps
DQS, /DQS Read preamble	tRPRE	0.9	-	tCK
DQS, /DQS differential Read postamble	tRPST	0.3	-	tCK
DQS, /DQS Write preamble	tWPRE	0.9	-	tCK
DQS, /DQS Write postamble	tWPST	0.3	-	tCK
DQS, /DQS low-impedance time	tLZ(DQS)	-450	225	ps
DQS, /DQS high-impedance time	tHZ(DQS)	-	225	ps
DQS, /DQS differential input low pulse width	tDQSL	0.45	0.55	tCK
DQS, /DQS differential input high pulse width	tDQSH	0.45	0.55	tCK
DQS, /DQS rising edge to CK, /CK rising edge	tDQSS	-0.27	+0.27	tCK
DQS, /DQS falling edge setup time to CK, /CK rising edge	tDSS	0.18	-	tCK
DQS, /DQS falling edge hold time to CK, /CK rising edge	tDSH	0.18	-	tCK
Delay from start of Internal write transaction to Internal read command	tWTR	Max (4tck, 7.5ns)	-	
Write recovery time	tWR	15	-	ns
Mode register set command cycle time	tMRD	4	-	tCK
/CAS to /CAS command delay	tCCD	4	-	nCK
Auto precharge write recovery + precharge time	tDAL	tWR+tRP/tck		nCK



Active to active command period for 1KB page size	tRRD	Max (4tck, 6ns)	-	ns
Speed		DDR3 1600		Unit
Parameter	Symbol	Min	Max	
Active to active command period for 2KB page size	tRRD	Max (4tck, 7.5ns)	-	
Four Activate Window for 1KB page size	tFAW	30	-	ns
Four Activate Window for 2KB page size products	tFAW	40	-	ns
Power-up and RESET calibration time	tZQinitl	512	-	tCK
Normal operation Full calibration time	tZQoper	256	-	tCK
Normal operation short calibration time	tZQcs	64	-	tCK
Exit self refresh to commands not requiring a locked DLL	tXS	Max (5tCK, tRFC+10ns)	-	
Exit self refresh to commands requiring a locked DLL	tXSDLL	tDLL(min)	-	tCK
Internal read to precharge command delay	tRTP	Max (4tck, 7.5ns)	-	
Minimum CKE low width for Self refresh entry to exit timing	tCKESR	tCK(min)+1tCK	-	
Exit power down with DLL to any valid command: Exit Precharge Power Down with DLL	tXP	Max (3tCK, 6ns)	-	
CKE minimum pulse width (high and low pulse width)	tCKE	Max (3tCK, 5ns)		
Asynchronous RTT turn-on delay (Power-Down mode)	tAONPD	2	8.5	ns
Asynchronous RTT turn-off delay (Power-Down mode)	tAOFPD	2	8.5	ns
ODT turn-on	tAON	-225	225	ps
ODT turn-off	tAOF	0.3	0.7	tCK

**SERIAL PRESENCE DETECT SPECIFICATION**

AQD-ED3L4G16R-SG Serial Presence Detect			
Byte No.	Function Described	Standard Specification	Vendor Part
0	Number of SPD Bytes written / SPD device size / CRC coverage during module production	CRC:0-116Byte SPD Byte use: 176Byte SPD Byte total: 256Byte	92
1	SPD Revision	Version 1.1	11
2	Key Byte / DRAM Device Type	DDR3 SDRAM	0B
3	Key Byte / Module Type	RDIMM	01
4	SDRAM Density and Banks	4Gb 8banks	04
5	SDRAM Addressing	ROW:16, Column:10	21
6	Module Nominal Voltage, VDD	1.35V and 1.5V	02
7	Module Organization	1Rank / x8	01
8	Module Memory Bus Width	ECC, 72bit	0B
9	Fine Timebase Dividend and Divisor	2.5ps	52
10	Medium Timebase Dividend	0.125ns	01
11	Medium Timebase Divisor	0.125ns	08
12	SDRAM Minimum Cycle Time (tCKmin)	1.25ns	0A
13	Reserved	-	00
14	CAS Latencies Supported, Least Significant Byte	6, 7, 8, 9,10,11	FC
15	CAS Latencies Supported, Most Significant Byte	-	00
16	Minimum CAS Latency Time (tAamin)	13.125ns	69
17	Minimum Write Recovery Time (tWRmin)	15ns	78
18	Minimum /RAS to /CAS Delay Time (tRCDmin)	13.125ns	69
19	Minimum Row Active to Row Active Delay Time (tRRDmin)	6ns	30
20	Minimum Row Precharge Time (tRPmin)	13.125ns	69
21	Upper Nibble for tRAS and tRC	-	11
22	Minmum Active to Precharge Time (tRASmin)	35ns	18
23	Minmum Active to Active/Refresh Time (tRCmin)	48.125ns	81
24	Minmum Refresh Recovery Time (tRFCmin), Least Significant Byte	260ns	20
25	Minmum Refresh Recovery Time ((tRFCmin), Most Significant Byte	260ns	08
26	Minmum Internal Write to Read Command Delay Time (tWTmin)	7.5ns	3C
27	Minimum Internal Read to Precharge Command Delay Time (tRTPmin)	7.5ns	3C
28	Upper Nibble for tFAW	30ns	00
29	Minmum Four Active Window Delay Time (tFAWmin)	30ns	F0
30	SDRAM Optional Features	DLL off Mode, RZQ/6, RZQ/7	83
31	SDRAM Thermal and Refresh Options	Normal Temp,No ASR	01
32	DDR3-MODULE THERMAL SENSOR	Support TS	80

33	DDR3-SDRAM DEVICE TYPE	Mono	00					
34-59	Reserved	-	00					
60	Module Nominal Height	30mm	0F					
61	Module Max Thickness	1~2mm	11					
62	Reference Raw Card Used	Rev. 0.0, R/C B	20					
63	DIMM Module Attributes	1 Row of DRAM , 1 Register used	05					
64	DDR3-HEATSPREADER SOLUTION	Without HS	00					
65	Register Manufacturer ID Code, Least Significant Byte	Inphi	04					
		IDT	80					
66	Register Manufacturer ID Code, Most Significant Byte	Inphi	B3					
		IDT	B3					
67	Register Revision Number	Inphi U2	21					
		IDT HLB	61					
68	Register Type	SSTE32882	00					
69	Register Control Word Funttion RC1/RC0	Rev 0.0 / RC H	00					
70	Register Control Word Funttion RC1/RC0	Rev 0.0 / RC H	50					
71	Register Control Word Funttion RC5/RC4	Rev 0.0 / RC H	00					
72-116	Reserved	-	00					
117	Module Manufacturer ID Code, Least Significant Byte	Transcend	01					
118	Module Manufacturer ID Code, Most Significant Byte	Transcend	4F					
119	Module Manufacturing Location	-	54					
120-121	Module Manufacturing Date	-	00					
122-125	Module Serial Number	-	00					
126-127	Cyclical Redundancy Code	-	-					
128-145	Module Part Number	AQD-D3L4GR16-SG	41	51	44	2D	44	33
			4C	34	47	52	31	36
			2D	53	47	20	20	20
146-147	Revision Code	-	00					
148-149	DRAM Manufacturer ID Code	By Manufacturer	Variable					
150-175	Manufacturer Specific Data	By Manufacturer	Variable					
176-255	Open for customer use	Undefined	00					

